

# ZAGUTO **EVF**

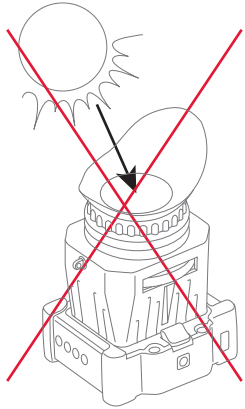

## USER MANUAL

MODEL: 1-EVF-1S  
1-EVF-1F



### Sunlight Precautions

- Do not allow sunlight to enter the Z-Finder while it is attached to the EVF. The light can be magnified by the lens and potentially cause damage to the EVF screen.
- Use the included sun shield to help prevent unwanted light from entering the EVF.
- Always use the included lens cap when the EVF is not in use.

- Do not use batteries, power cords or accessories that are not specified for use with this product. Use only canon LP-E6 batteries or equivalent. Check [Zacuto.com/zfinderevf](http://Zacuto.com/zfinderevf) for a complete list of compatible accessories.
- When using a power cord, be sure to plug it in completely. Do not handle power plugs when your hands are wet. When unplugging the power cord, grasp the plug body or adapter instead of the cord.
- Do not disassemble or modify the EVF, as this may damage the product.
- Do not store the EVF in a dusty, humid or hot environment as damage may occur.
- When the EVF is mounted on a camera, do not lift or move the camera by grabbing the EVF. This may cause damage to the EVF or the camera mount.
- This product is not waterproof. If the product is dropped in water, do not turn on the unit. Contact Zacuto for service.
- Do not apply cleaning fluid or liquid directly to the screen. Apply cleaner to the included cloth or a soft cotton cloth before wiping the screen.
- Do not apply excess pressure to the screen while cleaning or otherwise.
- Misuse of this product by the owner may void the warranty.

Precautions and Care .....	01
Table of Contents .....	02
Included Components .....	03
Optional Accessories .....	04
Physical Features .....	05
EVF Controls .....	05
Connecting the EVF to your camera .....	06
Connecting the EVF to an external monitor .....	06
Attaching the Hot-Shoe Mount .....	07
Adjusting the Hot-Shoe Mount .....	08
Using a rechargeable power source .....	09
Using an external power source .....	10
Attaching a Z-Finder .....	11
Operating the Menu .....	12
Brightness .....	13
Contrast .....	13
Chroma .....	13
Blue Only .....	14
Monochrome .....	14
Color Bars .....	14
Battery Level .....	14
Scaling .....	15
Frame Lines .....	16
Anamorphic .....	17
Focus Assist (Peaking) .....	17
Exposure Assist (Zebra) .....	18
False Color .....	18
Image Flip .....	20
Pixel to Pixel (Zoom) .....	20
Audio Meters .....	20
Frame Store .....	21
Feature Location .....	22
Assigned Function Buttons .....	22
Update .....	23
About .....	23
Possible Error Messages .....	24
Frequently Asked Questions .....	27
Specifications .....	29
Limited Warranty .....	30

# Included Components

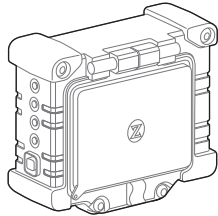

1 Zacuto EVF Unit w/ Dust Cover

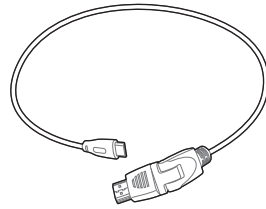

5 18" HDMI to HDMI Mini Cable

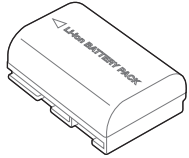

2 Li-ion Battery Pack

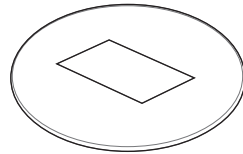

6 16x9 Sun Shield

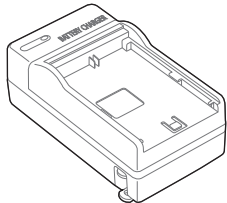

3 Li-ion Battery Charger

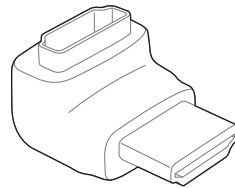

7 HDMI Right Angle Adapter



4 1/4"-20 Hot-Shoe Mount

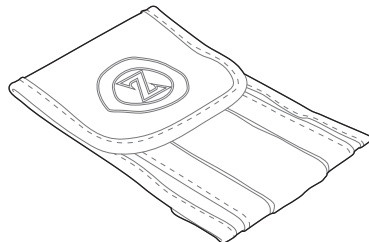

8 Protective Carrying Pouch

# Optional Accessories

\* Optional accessories may be purchased from the Zacuto web store at [www.Zacuto.com](http://www.Zacuto.com) or from any Zacuto authorized dealer.

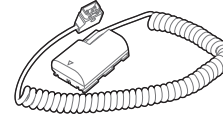

\* External Battery Attachment with D-Tap

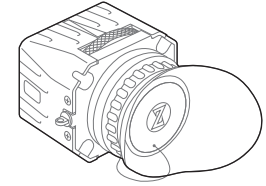

\* Zacuto Z-Finder Pro (Standard with Z-Finder EVF Pro)



\* 3ft HDMI to HDMI Cable

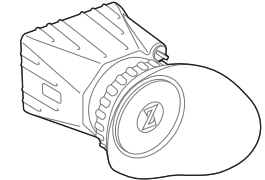

\* Zacuto Z-Finder Jr. (Standard w/ Z-Finder EVF)

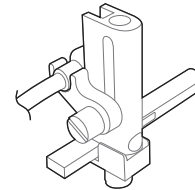

\* Pincher HDMI Cable Mount

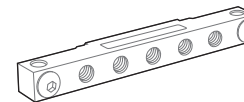

\* EVF Cheese Plate Bar w/ Screws

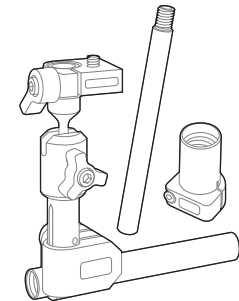

\* Zacuto Tri-Mount System with Zud and Additional 7" Male Rod

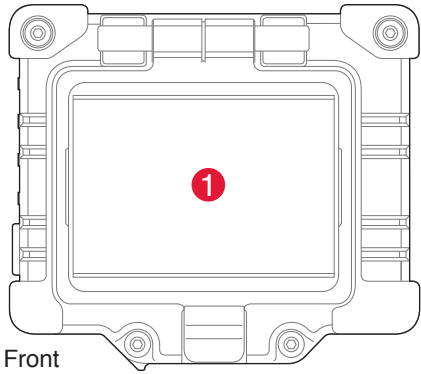

Front

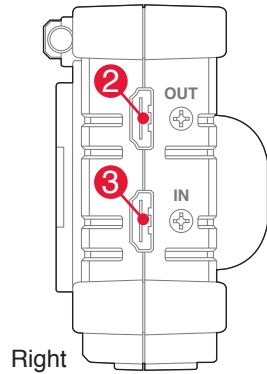

Right

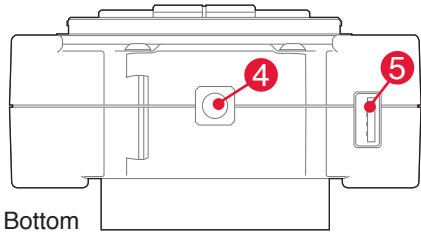

Bottom

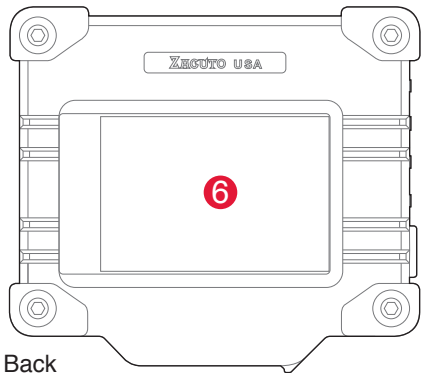

Back

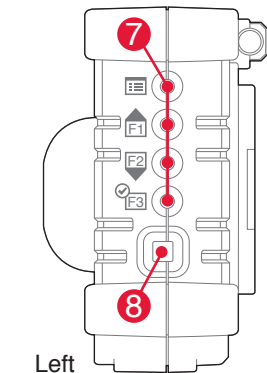

Left

- 1 HD LCD Screen
- 2 HDMI Out
- 3 HDMI In
- 4 1/4"-20 Screw Hole
- 5 USB Port
- 6 Battery
- 7 Function Buttons
- 8 Power Button

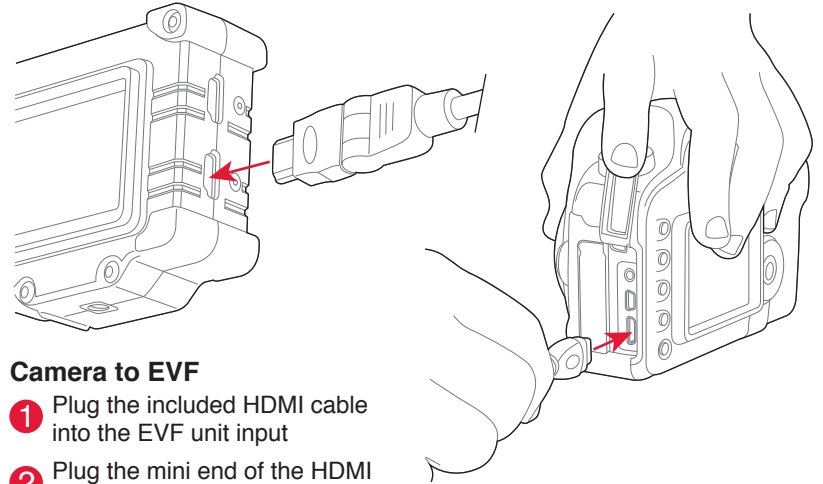

### Camera to EVF

- 1 Plug the included HDMI cable into the EVF unit input
- 2 Plug the mini end of the HDMI cable into your camera

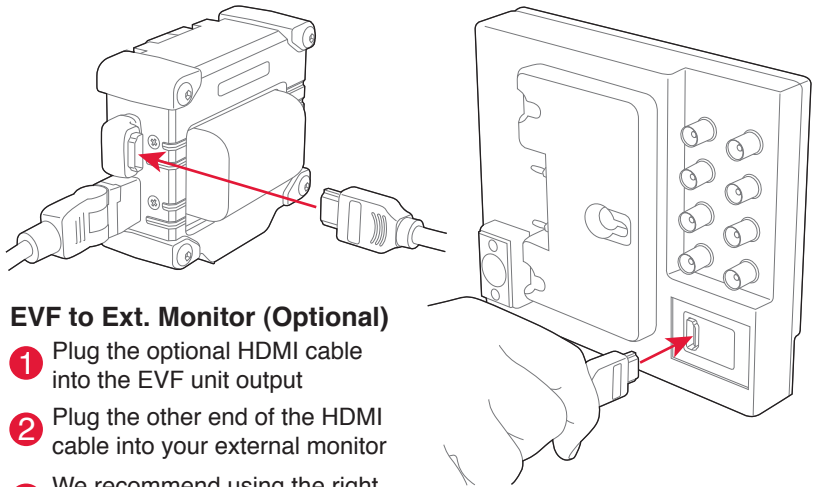

### EVF to Ext. Monitor (Optional)

- 1 Plug the optional HDMI cable into the EVF unit output
- 2 Plug the other end of the HDMI cable into your external monitor
- \* We recommend using the right angle adapter for best performance

## Attaching the Hot-Shoe Mount

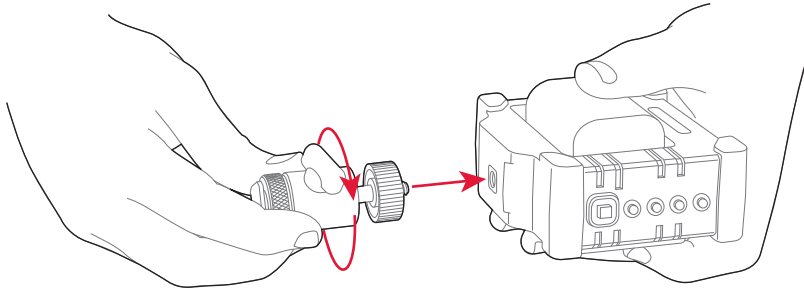

- 1 Screw the Hot-Shoe Mount into the bottom of the EVF unit

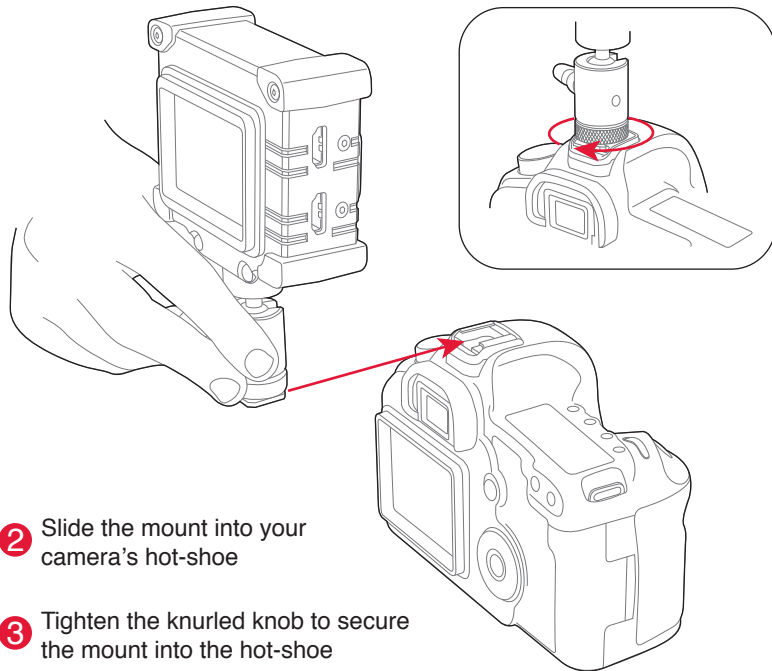

- 2 Slide the mount into your camera's hot-shoe
- 3 Tighten the knurled knob to secure the mount into the hot-shoe

## Adjusting the Hot-Shoe Mount

- 1 Loosen the knob on the Hot-Shoe Mount to free the apparatus

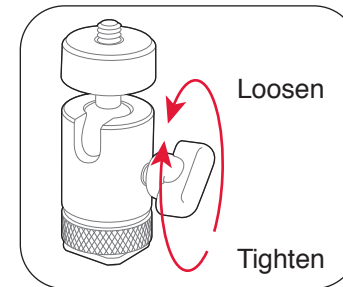
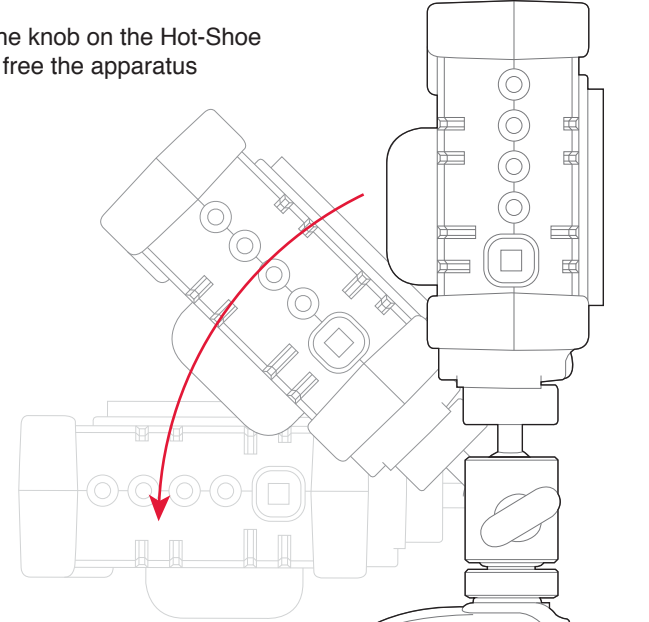

- 2 Position the EVF to your desired position and tighten the knob

## Using the Included Battery

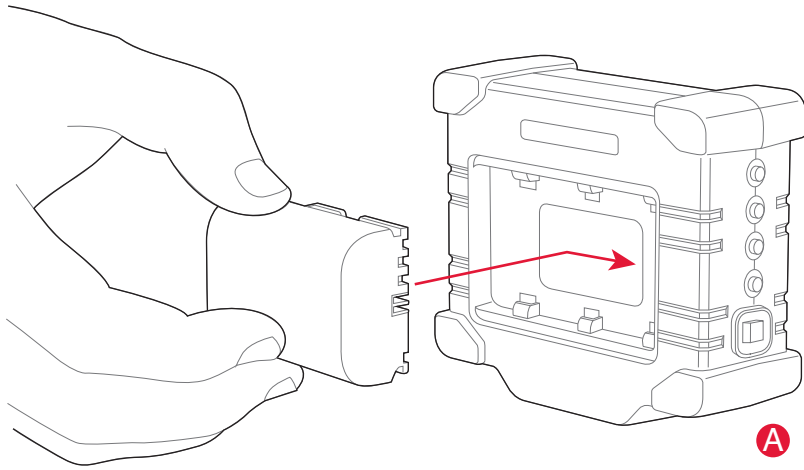

- A** Insert the battery into the compartment on the back of the EVF and slide it to the right to lock
- B** When battery power is depleted, slide the battery into the included charger

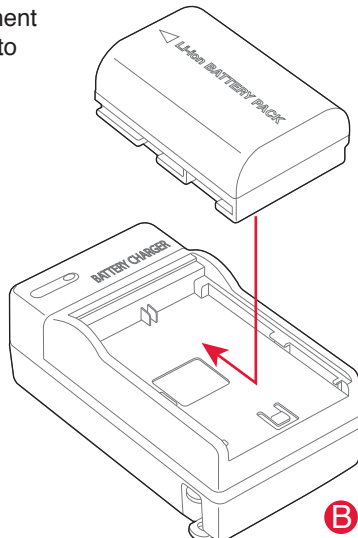

**\*** Note: Only use LP-E6 type batteries with the EVF unit. Doing otherwise may damage the unit and cause a malfunction.

## Using an External Power Source

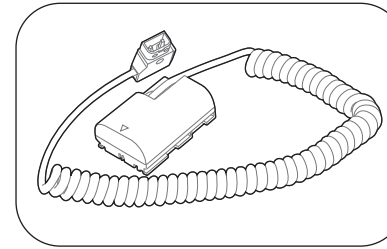

- \*** Optional equipment required
  - External battery attachment with D-Tap
  - Compatible battery source

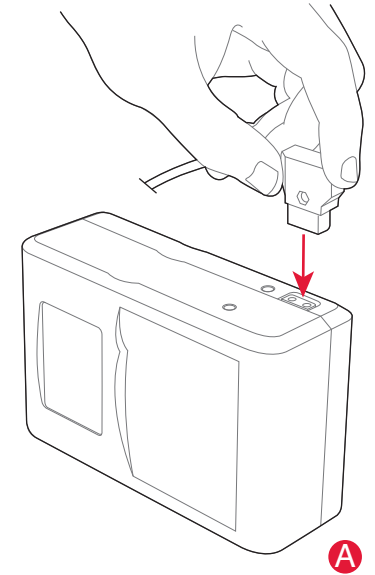

- A** Insert the male D-Tap end into a compatible power source
- B** Slide the battery adapter into the back of the EVF unit

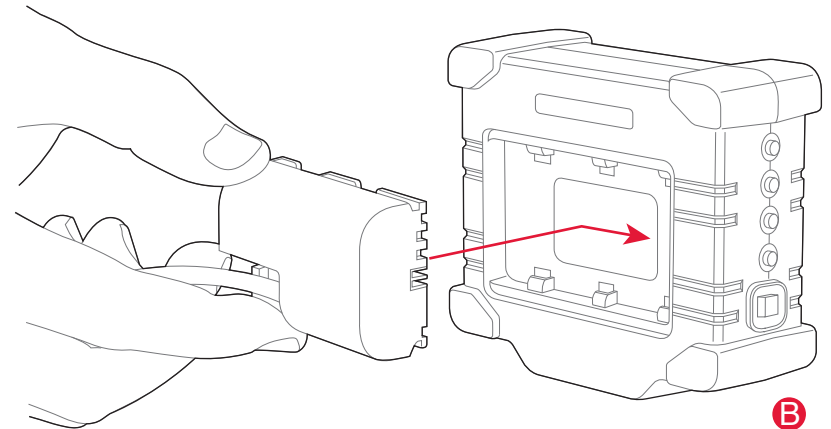

# Attaching a Z-Finder

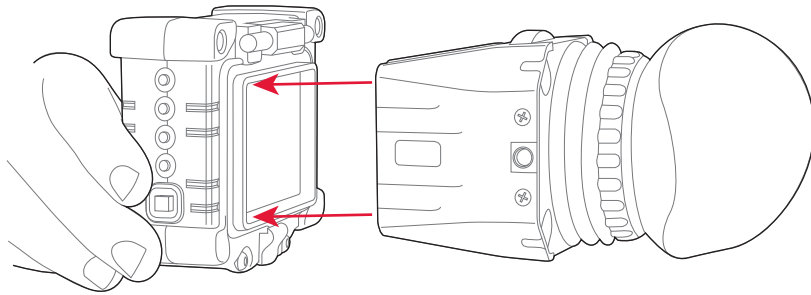

**A** Align the Z-Finder to the EVF unit and snap onto frame

**B** If using an EVF Flip, the Z-Finder may be flipped up and out of the way by releasing the red lever near the bottom of the unit

★ See Z-Finder instructions for complete installation and operation directions.

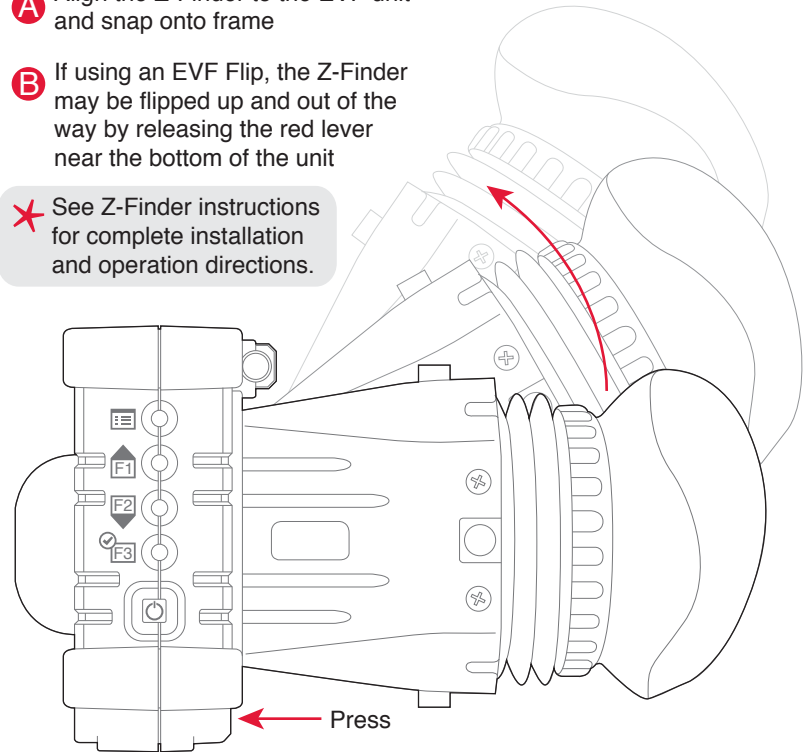

# Operating the Menus

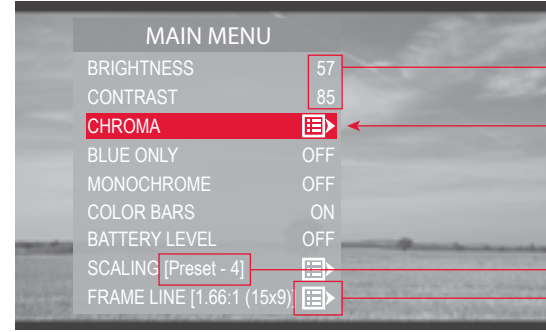

Current Setting (Numerical)

Current Selection (In Red)

Current Setting Sub-Menu Indicator

Current Video Display

★ The menu screen reveals itself over the current video display to show real-time updates of changes made.

- 1 Menu Button**
  - Display home menu screen
  - Return to top menu at any point from within the menu tree
- 2 Selection Button - UP (F1)**
  - Navigate up within menu
  - Activate the function assigned to F1
- 3 Selection Button - DOWN (F2)**
  - Navigate down within menu
  - Activate the function assigned to F2
- 4 Selection Button - CONFIRM (F3)**
  - Select the current highlighted option
  - Activate the function assigned to F3

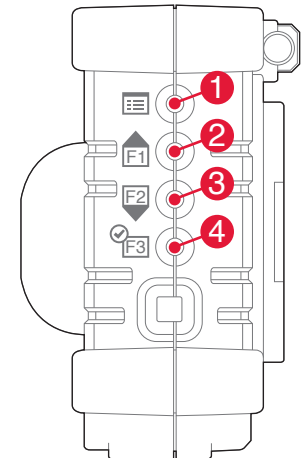

## Brightness

- Press the select button to reveal the brightness scale
- Use the up and down buttons to modify the current value
- Brightness ranges from -20 to +11 with a factory default of 0



## Contrast

- Press the select button to reveal the contrast scale
- Use the up and down buttons to modify the current value
- Contrast ranges from -11 to +3 with a factory default of 0



## Chroma

- Select a parameter and modify each value with the up and down buttons. Zero (0) is the factory preset and can be modified + or -
- Select SATURATION to modify the overall amount of color in the image
- Select the RED, GREEN or BLUE options to modify the amount of color in each individual channel
- Your settings may be saved and recalled with the SAVE PRESET and RECALL PRESET functions



## Blue Only

- Press the select button to toggle this setting ON or OFF
- Use this setting to obtain proper calibration of your monitor when using color bars

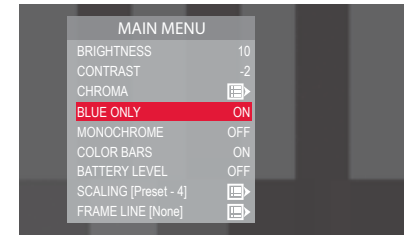

## Monochrome

- Press the select button to toggle this setting ON or OFF
- Use this setting to obtain proper calibration of the EVF when using color bars

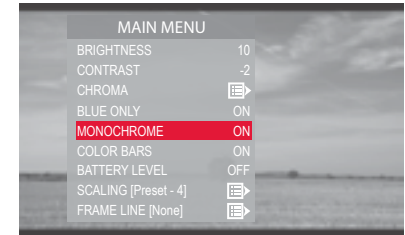

## Color Bars

- Press the select button to toggle this setting ON or OFF
- The color bars may be used to check the calibration of the EVF



## Battery Level

- Toggle this setting ON to constantly display the battery meter on the screen
- If turned OFF, the low battery icon will appear when a battery charge is necessary

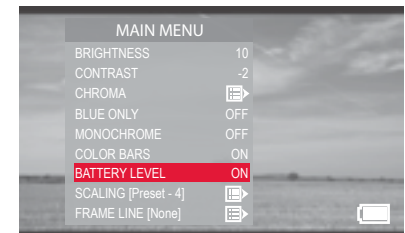



## Scaling (See tutorial video at [www.zacuto.com/zfinderevf](http://www.zacuto.com/zfinderevf))

- AUTO / PLAYBACK allows the EVF to scale and format the image by automatically detecting the camera's output (Default)
- Choose CAMERA PRESETS to activate an included camera preset

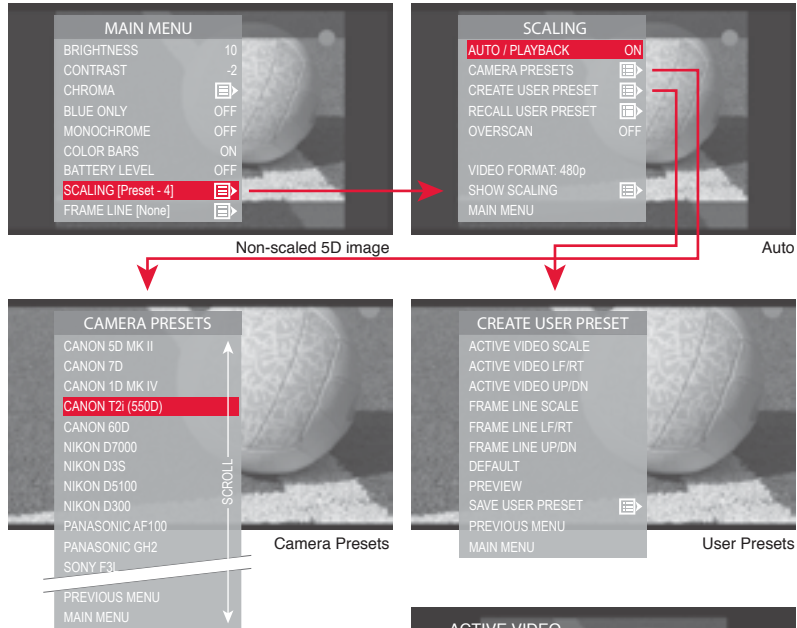

- When creating a user preset, the ACTIVE VIDEO (Red Line) represents what will be shown full frame on the screen while the FRAME LINE (Green Line) tells the EVF where the picture area of the recorded video image will be
- Frame line type is selected in the FRAME LINE menu
- Creating a user preset may be useful if you are trying to view camera data on the screen while it is scaled

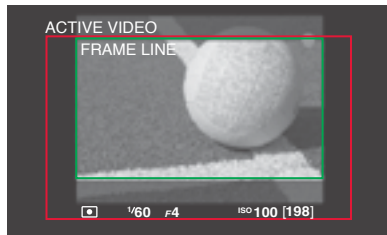

- ✳ If your camera outputs a different format during standby and record, ie: Canon 5D (1080i/480p) the scaling must be set and saved to the same preset for both modes.
- You can PREVIEW and SAVE a user setting while in the CREATE USER PRESET menu. After saving you can recall a preset in the RECALL USER PRESET menu
- OVERSCAN can be toggled ON or OFF from the scaling menu

## Frame Lines

- Choose the frame lines that you wish to display on screen
  - You are able to toggle ON or OFF the frame lines and/or action safe within each selection
- ✳ When not using a camera preset, a USER PRESET is necessary for the frame lines to be displayed correctly (see scaling on pg.15)

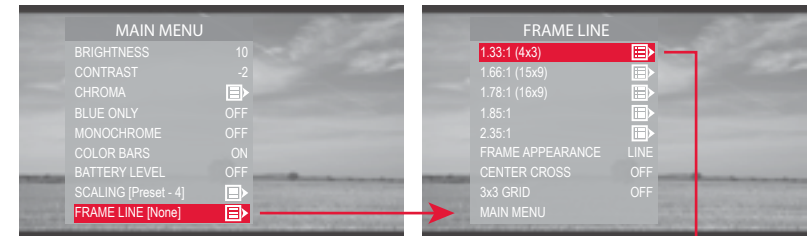

- FRAME APPEARANCE can be toggled to either LINE or BOX

## Anamorphic

- Choose the correct anamorphic setting for your lens from the list

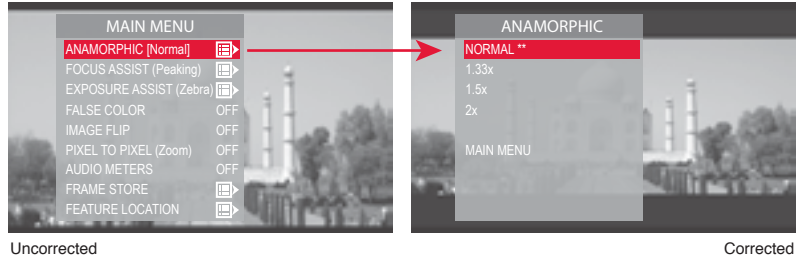

## Focus Assist (Peaking)

- Press the select button to enter the peaking menu
- Toggle ENABLE ON or OFF by selecting it from the menu
- Select the LEVEL option and use the arrows to choose the peaking intensity

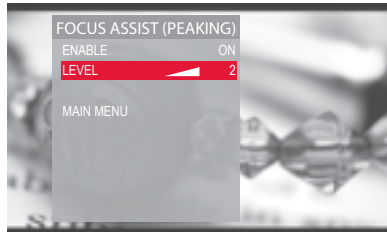

- The EVF uses a sharpening method to enhance hard edges to aid in focusing the image. When an object is in focus the edges will be intensified

## Exposure Assist (Zebra)

- Choose "ENABLE" to turn on the exposure assist
- Choose the zebra detection IRE value appropriate for your needs

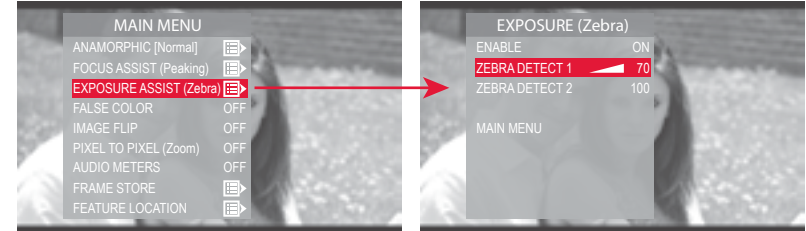

- ZEBRA DETECT 1 lines will be the first to appear when the exposure reaches the specified IRE value

- Note: A value below 1 or above 109 disables that zebra
- Note: Zebra detect 1 must be a lower value than detect 2



Exposure Assist ON

## False Color

- Select FALSE COLOR to toggle the setting ON or OFF
- Use False Color to aid in obtaining the correct exposure of your scene

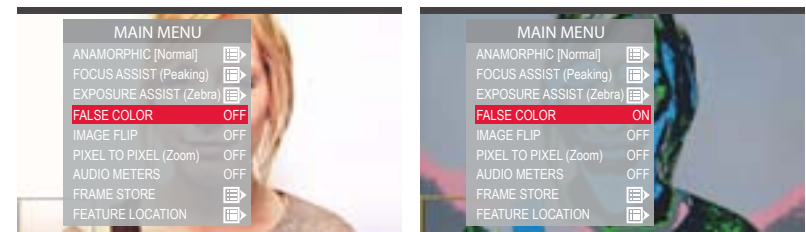

- The chart below may be used as a key to determine which areas of your frame are overexposed, underexposed or exposed properly.

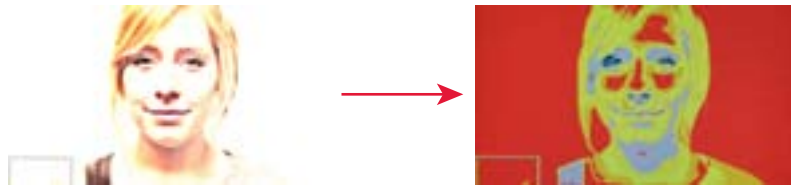
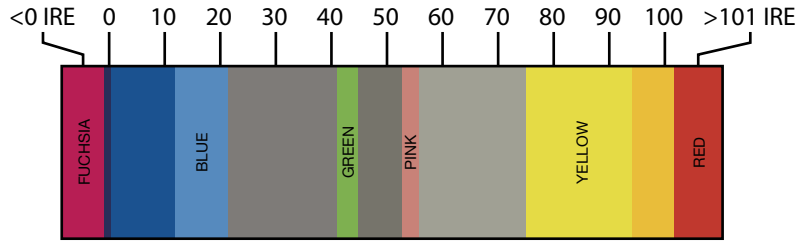

**Overexposed:** Objects will be displayed RED

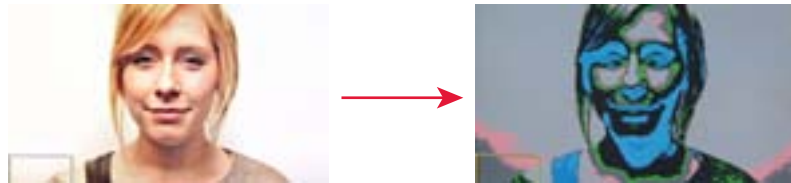

**Properly Exposed:** Objects will display in PINKS and GREENS

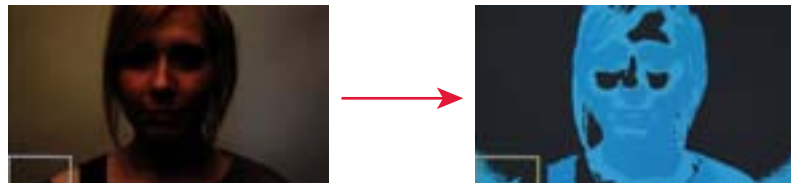

**Underexposed:** Objects will display BLUE to DARK BLUE

## Image Flip

- Press the select button to toggle the IMAGE FLIP ON or

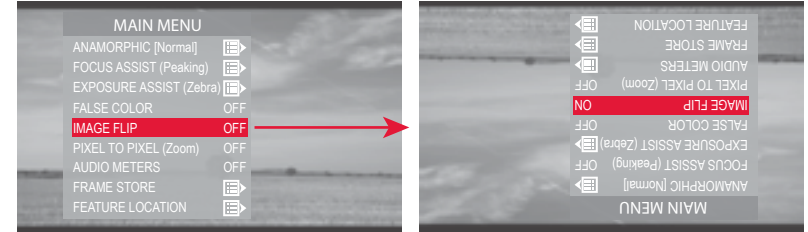

## Pixel To Pixel (Pixel to Pixel not active while in 480p)

- Press the select button to toggle PIXEL TO PIXEL ON or OFF

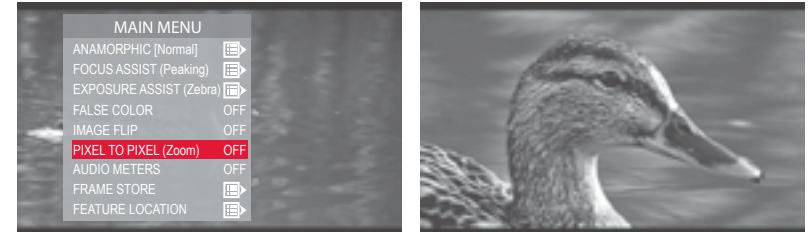

## Audio Meters

- Press the select button to toggle the AUDIO METERS ON or OFF
- ✳ Audio meters are only active during playback with most DSLR cameras



## Frame Store

- Press the select button to enter the FRAME STORE menu. Select STORE NUMBER and toggle through each number with the selector arrow to select a stored frame memory bank

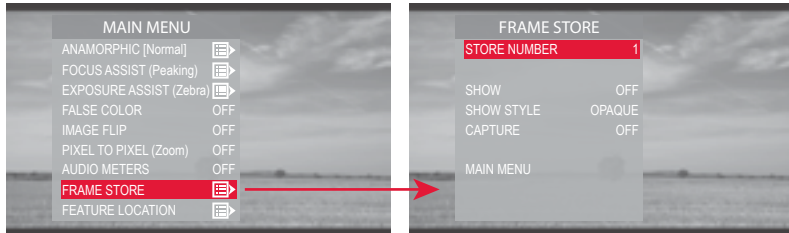

- Toggle SHOW ON or OFF to display the stored frame in the selected memory bank. If no frame has been stored in the selected bank, a warning message reading “Frame (X) has not been stored!” will appear

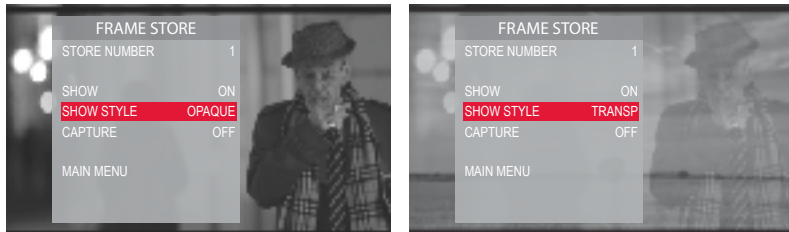

- Within SHOW STYLE, you may choose for the saved frame to be overlaid as OPAQUE or TRANSP allowing you to match your live video to the stored frame
- Toggle the CAPTURE function to ON and you will be prompted with a message “Press any Function Key to store frame...” Press a Function Key on the side of the EVF and a frame from the current video on screen will be stored to the next available memory bank



## Feature Location

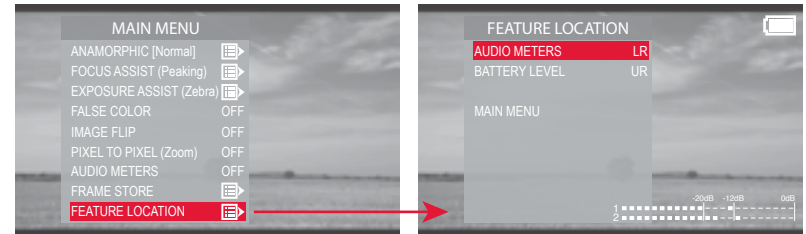

- Select the feature you want to place and scroll through the options with the selector arrows. Once one feature is placed, press the select button to back out of the selection and choose another

## Assigned Function Buttons

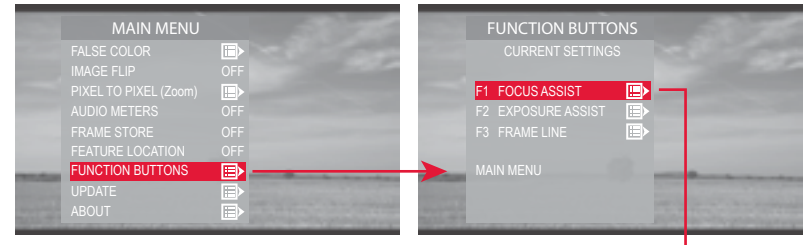

- To change the function assigned to each button, first select the button you wish to change from the list
- From the subsequent menu, choose the desired function and select it. It can now be activated by pressing the appropriate function button on the side of the EVF unit without the use of the menu system

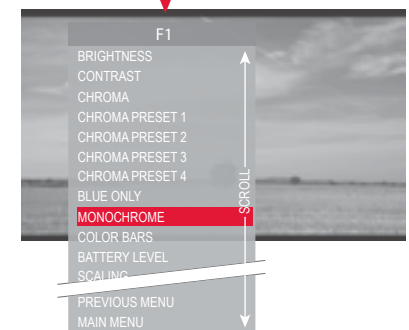

## Update (For more information visit [www.zacuto.com/zfinderevf](http://www.zacuto.com/zfinderevf))



- Format your USB thumb drive to FAT32 for compatibility
- Download the firmware update from [zacuto.com](http://zacuto.com), click on the PRODUCTS tab and choose Z-FINDER EVF SUPPORT. Once downloaded, drag the file onto your thumb drive
- Insert the thumb drive into your EVF, select UPDATE from the menu and select USB DRIVE. Choose START UPDATE. The current firmware version may be confirmed in the ABOUT menu
- Factory settings may be restored with RESTORE FACTORY DEFAULTS

## About

- Choose ABOUT to view the EVF firmware version on your device



## Possible Error Messages

✳ You may receive these messages if there is an error during the update process. Contact Zacuto customer support if your problem persists after following these recommendations.

### Problem:

#### Invalid USB Drive

Your USB drive has been detected but the EVF cannot recognize it

### Solution:

Remove the drive and re-insert or attempt to use a different USB drive that has been properly formatted



### Problem:

#### No USB Drive Detected

Your USB drive cannot be detected by the EVF

### Solution:

Make sure the USB drive is completely inserted and/or attempt to use a different USB drive that has been properly formatted

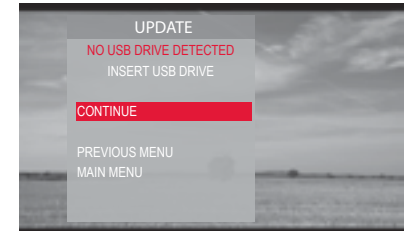

### Problem:

#### No Valid Image Detected

An invalid firmware image has been detected on your USB

### Solution:

Your image has been corrupted. Try downloading the image again and retry. Use a different USB drive if the action continues to fail

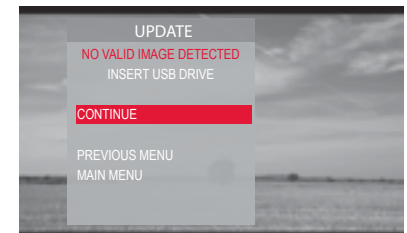

**Problem:**  
You have attempted to use the PIXEL-TO-PIXEL (zoom) feature while in 480p standby or record

**Solution:**  
If possible, set the output of your camera to a higher format than 480p to be able to use the PIXEL-TO-PIXEL zoom feature

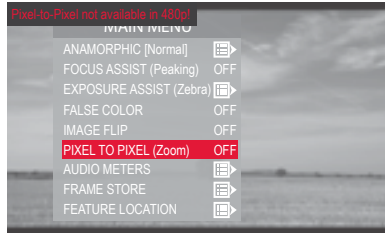

**Problem:**  
You have attempted to set the ZEBRA 2 value below the ZEBRA 1 value

**Solution:**  
Set the ZEBRA 1 lower than ZEBRA 2 or increase the level of ZEBRA 2 so that it is higher than ZEBRA 1

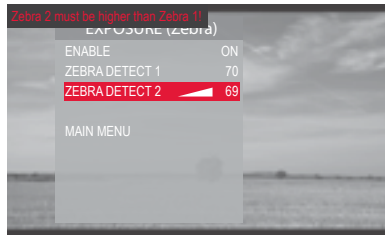

**Problem:**  
You have attempted to show a stored frame that doesn't exist in the EVF's memory

**Solution:**  
Use the capture option to save a frame of video into the selected memory bank

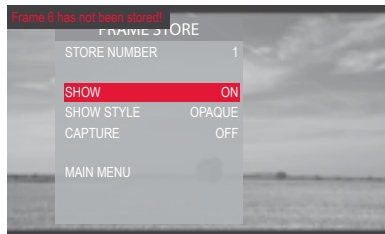

**Problem:**  
The EVF is unable to detect a signal from an input device through the HDMI cable

**Solution:**  
Make sure the HDMI cable is securely plugged into your camera and that your camera is in video mode

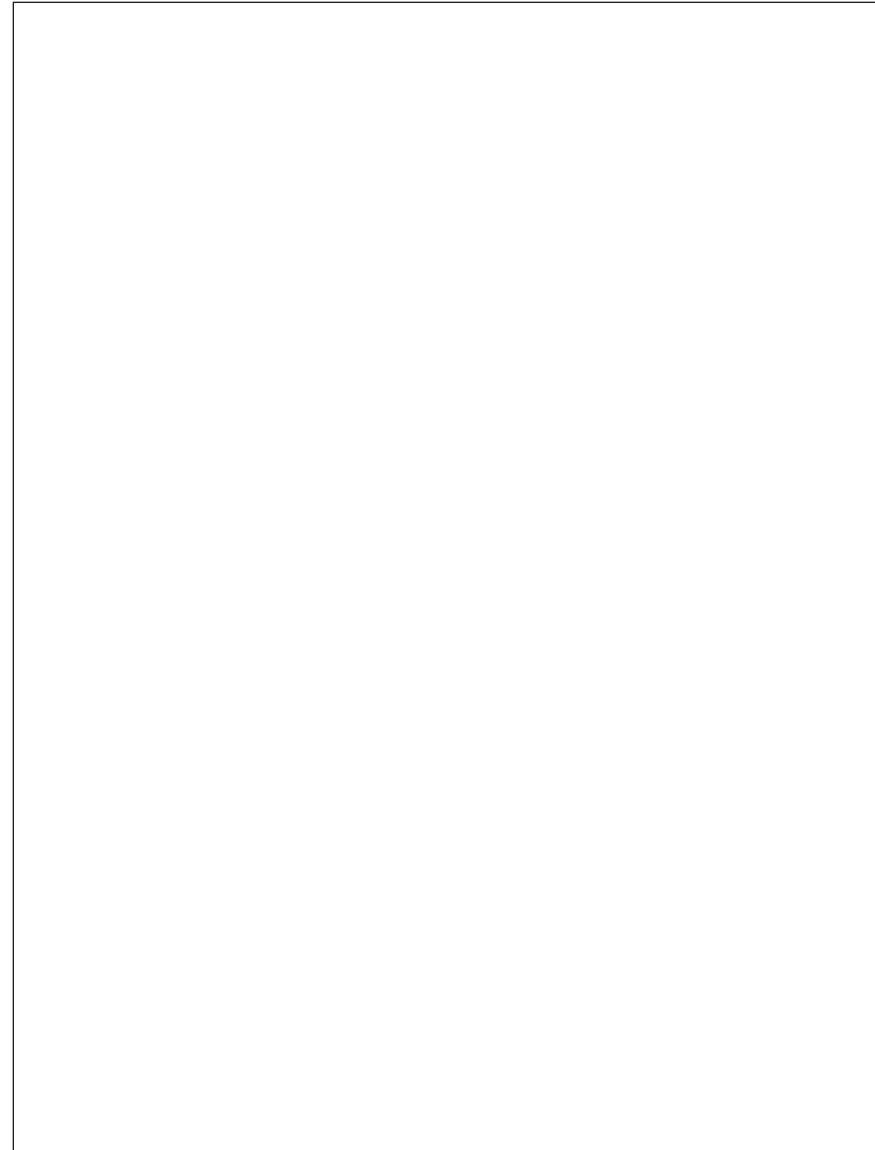
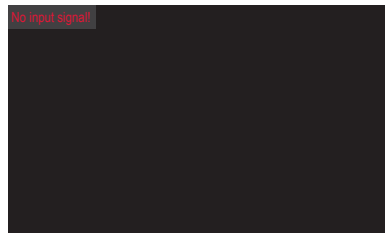

See the full list of questions at [www.Zacuto.com/zfinderevf](http://www.Zacuto.com/zfinderevf)

**Q: Will this EVF have HD-SDI?**

**A:** Not this version. We hope to make another version or converter with HD-SDI later down the road. Adding HD-SDI does add cost and we wanted to keep the cost as low as possible. Only a small majority of users are interested in HD-SDI so it doesn't make sense to have everyone have to pay for a feature that most will not use. Because every camera, including the new Sony F3, AG-AF100 and DSLR cameras use (HDMI, we went that way.) The future model or converter will allow you to come in HDMI and cross convert to HD-SDI for output to an HD-SDI monitor. It will also allow you to accept HD-SDI as an input.

**Q: Will I be able to use my Z-Finder EVF and Z-Finder EVF Pro straight out of the box without buying anything else?**

**A:** Yes, it will come with everything you need: a hotshoe ball mount, rechargeable battery, battery charger, HDMI cable & case. You can start shooting with it immediately. If you already own a Z-Finder Jr. or Pro, you can purchase the EVF snap or EVF Flip and be ready to shoot straight out of the box.

**Q: Why is anti-fog so important?**

**A:** When an EVF or optical viewfinder fogs up, game over. It becomes unusable. Zacuto spent a lot of time coming up with our anti-fog formula. Z-Finder version 1 owners complained about fog more than any other issue. Your normal body temperature is almost 100 degrees but the Z-Finder optic will never reach that point. The human body also naturally puts out a lot of moisture. These two factors combined means that any optical viewfinder will fog. To eliminate the fog, you need to separate yourself from the viewfinder to let the fog dissipate, and then you can begin to shoot again. This is a huge problem when doing shots over 30 seconds. You must have anti-fog to really have a usable product. We rectified the problem with the anti-fog protective covers. Our Z-Finder Pro models come with two expendable anti-fog protective covers. All Zacuto version 1 Z-Finders can easily and inexpensively be upgraded to anti-fog with the addition of the Anti-Fog Protective Upgrade Kit.

**Q: Why does my EVF have excessive strobing while panning?**

**A:** We have tested the EVF for what people have complained as excessive strobing while panning and have discovered that our EVF does not strobe any more than any other monitor. It appears that way because you are magnifying the image with the Z-Finder.

**Q: Why can't I get a picture when I plug-in the HDMI cable while the EVF is on?**

**A:** This is not unique to the Zacuto EVF. If the EVF is already on, you must plug in the HDMI cable in one swift movement with no stopping or hesitation. It has to do with the communication or "handshake" between the two devices.

## LCD

Size	3.2" TFT LCD IPS LED
Resolution	800x480
Color	16.7 Million
Viewing Angle	H: 170 Degrees V: 170 Degrees
View Area	70.6mm (H) x 42.76mm (V)

## POWER

Battery	7.2v Canon LP-E6 or Equivalent
External	12 Volt Power Adapter (Optional)
Consumption	2.5W (5.2 Hours w/ 1800mAH Battery)

## VIDEO INPUT / OUTPUT

HDMI	480i / 480p / 576p / 720p / 1080i / 1080p @ 24, 25 and 30fps
------	--

## TEMPERATURES

Operating	-4F to +158F / -20C to +70C
Storage	-22F to +176F / -30C to +80C

All LCD panels have dead pixels or dots if you look with a magnifier. With our EVF both situations apply. When the Z-Finder is on the EVF screen, we are magnifying so dead pixels become more noticeable. When the EVF is up you are not magnifying so dead pixels or dots are unnoticeable.

### Our policy is:

**Without Magnification:** 0 dead white pixels and 0 dead Red, Green or Blue dots visible with the naked eye.

**With 2.5x or 3x Magnification:** No more than 2 dead white pixels outside the critical middle third or 5 dead Red, Green or Blue dots.

**Zacuto USA** electronic devices come with a limited one year hardware warranty. The limited hardware warranty covers defects in workmanship and materials of our products for up to one year. This warranty does not cover any damage to this product that results from improper installation, accidents, abuse, misuse, negligence, natural disaster, insufficient or excessive electrical supply (if applies), abnormal mechanical or environmental conditions, dust or any unauthorized disassembly, repair or modification.

For the most up to date manual, features, firmware and tutorial videos, go to the Zacuto EVF page at [www.zacuto.com/zfinderevf](http://www.zacuto.com/zfinderevf)

Zacuto USA, Z-Finder and Z-Finder EVF are trademarks of Zacuto USA





[www.zacuto.com](http://www.zacuto.com)