



FREESPEAK DIGITAL WIRELESS

INSTRUCTION MANUAL

Version 2.0.2

FreeSpeak Instruction Manual

© 2007, 2008, 2009 Vitec Group Communications Ltd. All rights reserved.

Part Number 810340Z Rev. 8

Vitec Group Communications LLC
850 Marina Village Parkway
Alameda, CA 94501
U.S.A

Vitec Group Communications Ltd
7400 Beach Drive
IQ Cambridge
Cambridgeshire
United Kingdom
CB25 9TP

The Vitec Group plc
Beijing Representative Office
Room 706, Tower B
Derun Building, YongAn Dongli A No.3
Jianwai Ave., Chaoyang District
Beijing, P.R.China 100022

® Clear-Com, CellCom/FreeSpeak and the Clear-Com Communication Systems logo are registered trademarks of The Vitec Group plc

Website: www.clearcom.com

Vitec Group Communications

SOFTWARE LICENSE

IMPORTANT: CAREFULLY READ THE FOLLOWING BEFORE USING THIS SOFTWARE. USING THE SOFTWARE INDICATES YOUR ACKNOWLEDGMENT THAT YOU HAVE READ THE FOLLOWING AND AGREE TO ITS TERMS.

IF YOU DO NOT AGREE, RETURN THE SOFTWARE COMPLETE TO VITEC GROUP COMMUNICATIONS LIMITED OR CANCEL THE INSTALLATION.

THIS IS YOUR PROOF THAT YOU HAVE A VALID LICENSE. PLEASE TREAT IT AS VALUABLE PROPERTY.

VITEC GROUP COMMUNICATIONS LIMITED OR VITEC GROUP COMMUNICATIONS, INC., as the case may be (hereinafter referred to as “VGC”), offers you this storage media containing a computer program and files (the “SOFTWARE”) and offers to grant to you a non-exclusive and non-transferable License to use the Software on the following terms. Any new revision or update of the Software provided by VGC to Customer under this License shall be governed by the terms and conditions of this License.

1. APPLICATION

- a. These terms supersede all prior agreements representations and understandings between you the Customer and VGC and their authorised representatives relating to the subject matter hereof (i.e., the Software) but shall otherwise be subject to Vitec Group Communications Terms and Conditions, as amended from time to time. For the avoidance of doubt, in the event of conflict, these terms shall prevail.
- b. No variation to these terms, nor any other terms or conditions proposed by you, shall be of any effect unless recorded in a written document signed by VGC. You confirm that any statement made to the contrary by you or on your behalf shall not apply to this License.
- c. You confirm that you are not relying on any statement made by or on behalf of VGC, other than statements recorded in a written document signed by VGC.
- d. VGC and its licensors reserve all rights not expressly granted to you. VGC's licensors are intended third party beneficiaries of this Agreement and have the express right to rely upon and directly enforce the terms set forth herein.
- e. You agree that the Software belongs to VGC and its licensors. You agree that you neither own nor hereby acquire any claim or right of ownership to the Software or to any related patents,

copyrights, trademarks or other intellectual property. VGC and its licensors retain all right, title and interest in and to the Software and all copies thereof at all times, regardless of the form or media in or on which the original or other copies may subsequently exist. This license is not a sale of the original or any subsequent copy.

2. COPYRIGHT

a. The copyright and all other rights in the Software produced by VGC shall remain with VGC or its suppliers. You must reproduce any copyright or other notice marked on the Software on any copies that you make.

3. YOU MAY:

- a. Use the Software only at a single site location. If you wish to use the Software at more than one site you must contact VGC and if required purchase further Licenses;
- b. Make one copy of the Software for archival or back-up purposes, and;
- c. Transfer the Software to an end user of a VGC product, only if you have made it clear to VGC that you are not the end user and you assign all of your rights under this License and make no use of the Software yourself.

4. YOU MAY NOT:

- a. Use the Software or make copies of it except as permitted in this License;
- b. Publish or distribute the computer images, sound files or fonts included with the Software as computer images, sound files or fonts;
- c. Translate, reverse engineer, decompile or disassemble the Software, except to the extent the foregoing restriction is expressly prohibited by applicable law;
- d. Rent, lease, assign or transfer the Software except as set out above; or
- e. Modify the Software or merge all or any part of the Software in another program.

5. TERM:

a. This License shall continue for as long as you use the Software. However, it will terminate if you fail to comply with any of its terms or conditions. You agree, upon termination, to destroy all copies of the Software. The Limitations of Warranties and Liability set out below shall continue in force even after any termination.

6. LIMITED WARRANTY:

a. VGC warrants that the storage media in this Software will be free from defects in materials and workmanship for 90 days from the date you acquire it. If such a defect occurs, return it to us at the address below and we will replace it free. This remedy is your exclusive remedy for breach of this warranty.

b. After the initial 90 days, THE SOFTWARE IS PROVIDED "AS IS" WITHOUT WARRANTY OF ANY KIND EITHER EXPRESS, IMPLIED OR STATUTORY, INCLUDING BUT NOT LIMITED TO THE IMPLIED WARRANTIES OF MERCHANTABILITY, FITNESS FOR A PARTICULAR PURPOSE, PERFORMANCE, ACCURACY, RELIABILITY, OR NON-INFRINGEMENT OF THIRD-PARTY INTELLECTUAL PROPERTY RIGHTS. This constitutes an essential part of this License.

7. LIMITATION OF LIABILITY:

a. For the avoidance of doubt, all conditions imposed by law covering matters such as fitness for purpose, compliance to description, negligence and quality are expressly excluded from this agreement and you agree to accept the foregoing warranty in lieu of all such items.

b. IN NO EVENT SHALL VGC BE LIABLE FOR ANY LOSS OF PROFITS, LOSS OF BUSINESS, LOSS OF DATA OR USE OF DATA, INTERRUPTION OF BUSINESS, OR FOR INDIRECT, SPECIAL, INCIDENTAL, EXEMPLARY, MULTIPLE, PUNITIVE OR CONSEQUENTIAL DAMAGES OF ANY KIND, WHETHER BASED ON CONTRACT, TORT (INCLUDING WITHOUT LIMITATION, NEGLIGENCE), WARRANTY, GUARANTEE OR ANY OTHER LEGAL OR EQUITABLE GROUNDS, EVEN IF VGC HAS BEEN ADVISED OF THE POSSIBILITY OF SUCH DAMAGES.

c. The warranty is personal to you (or end user if you have made it clear that you are not the end user) and may not be transferred (except as permitted expressly above).

d. VGC shall not be liable for failure to perform any obligation to you where such failure is due to circumstances beyond VGC's reasonable control.

e. VGC offers extended warranties and, if you are not satisfied with the above, you should consider such warranties or consider separate insurance.

8. RESTRICTED RIGHTS:

If this Software is acquired by or for the U.S. Government then it is provided with Restricted Rights. Use, duplication, or disclosure by the U.S. Government is subject to restrictions as set forth in subparagraph (c)(1)(ii) of The Rights in Technical Data and Computer Software clause at DFARS 252.227-7013, or subparagraphs (c)(1) and (2) of the Commercial Computer Software - Restricted Rights at 48 CFR 52.227-19, or clause 18-52.227-86(d) of the NASA Supplement to the FAR, as applicable. Contractor/manufacturer: Vitec Group Communications Limited, 7400 Beach Drive, Cambridge, England CB25 9TP or Vitec Group Communications, LLC., 850 Marina Village Parkway, Alameda, CA 94501.

9. OTHER ISSUES:

a. Any failure by VGC to insist on its strict rights under this Agreement shall not be deemed to be a waiver of those (or any

other rights) and only a duly executed written release shall constitute such a waiver.

b. If any of these conditions is deemed invalid or unenforceable the remainder shall be unaffected.

c. VGC's dealings with you shall be governed by English law if you are resident in the EMEA region and California law if you are resident elsewhere. The federal and state courts of California for Non-EMEA Customers and English Courts for EMEA Customers shall have exclusive jurisdiction to adjudicate any dispute arising out of this Agreement.

d. If any document is written in more than one language the English text shall prevail.

e. Capitalized terms not defined herein shall have the meanings set forth in Vitec Group Communications' Terms and Conditions, as amended from time to time.

CONTENTS

GETTING STARTED: AN INTRODUCTION TO FREESPEAK	1-1
FreeSpeak Features	1-2
A FreeSpeak Communication System	1-3
Important Installation Information	1-5
System Password	1-5
Default Map	1-5
QUICK START	2-1
Creating a Wireless Party Line	2-8
Assigning the Wireless Party Line Label to FreeSpeak Beltpack Keys	2-8
Calling the Wireless Party Line from the Beltpacks	2-9
Calling the Wireless Party Line from the 4-Wire Audio Device	2-10
Calling the Wireless Party Line from the Wired Party-Line Beltpack	2-11
OPERATING THE FREESPEAK BASESTATION	3-1
Introduction	3-1
Understanding Front-Panel Operation	3-2
Headset Connector	3-2
& Channel A Talk Switch and Light/Listen Level Knob	3-2
A/B Reply Button	3-3
& Channel B Talk Switch and Light/Listen Level Knob	3-3
Party Line Channels A and B Enable Switches	3-3
Program Audio Enable Switch and Light	3-3
Antenna Light Display	3-3
Display Screen	3-4
Setup/Enter Knob	3-4
Power Switch	3-4
CONNECTING THE FREESPEAK BASESTATION	4-1
Understanding the Back-Panel Connectors	4-1
IEC Power Connector	4-2
Party Line Channel A Connectors	4-2
Party Line Channel B Connectors	4-2
Program Input Connector	4-2

Stage Announce Output Connector	4-2
Stage Announce Relay	4-3
4-Wire Matrix Ports	4-3
Base Loop Connector (not used)	4-3
LAN Connector	4-3
PC Connector	4-3
Transceiver Connectors	4-3
Connecting to Party-Line Intercom Systems	4-4
Clear-Com and Compatible Party-Line	4-4
Connecting Directly to Clear-Com Party-Line Beltpacks	4-5
Connecting to an RTS™ Wired Beltpack	4-6
Front-Panel Adjustments for Party-Line Connections	4-6
Troubleshooting Party-Line Connections	4-8
Reducing FreeSpeak Beltpack echo when talking to a analogue party-line	4-8
How to set the microphone gain in the beltpack	4-8
Include the Party-Line channel inside a Wireless Party-Line group	4-8
How to set the VOX gating level on the Party-Line connected to the Basestation	4-8
Auto null the Party-Line channel at the Basestation	4-9
Wireless Party Line	4-10
Connecting to 4-Wire and Digital Matrix Intercom	4-10
Connecting with Clear-Com Matrix Plus	4-12
Connecting with Clear-Com Eclipse Digital Matrix	4-12
Connecting with Other Digital Matrix Intercom Systems	4-13
Connecting with Other 4-Wire Devices	4-14
Connecting to a Program Audio Source	4-14
IFB Configuration	4-15
Connecting to the Stage Announce Output	4-16
Connecting to a PC	4-17
Connecting Via the Serial Port	4-17
Connecting Via the LAN Port	4-18
Connecting to Transceiver/Antennas (FS-TA)	4-18
Connecting One Transceiver/Antenna (FS-TA) Directly to A Transceiver Port	4-18
Connecting Transceiver/Antennas with a Splitter (PD2203)	4-19
Powering an Antenna or Antenna Splitter	4-20
PROGRAMMING A SYSTEM FROM THE BASESTATION	5-1
A Note About Terminology	5-2

Using the Basestation's Programming Menus	5-2
Saving Changes	5-2
Basestation Password	5-2
Changing Beltpack Labels	5-4
Setting and Changing Port Labels	5-6
Setting and Changing Group Labels	5-7
Adding Group Members	5-10
Beltpacks	5-11
Assigning Labels to Beltpacks Keys	5-11
Setting the Beltpack Audio Level	5-14
Setting Beltpack Latching	5-14
Setting Beltpack Groups	5-15
Setting Beltpack Labels	5-16
Registering a Beltpack	5-16
Setting Input and Output Port Levels	5-17
Setting Port Call Destination	5-19
Configuring a Party Line	5-22
Basestation SYSTEM Menu	5-26
System INFO ("INFO")	5-27
Restoring the Defaults ("DEFAULT")	5-27
ANTENNAS ("ANTENNAS")	5-27
Setting the IP Address ("IP")	5-28
Locking Front-Panel Enable Buttons ("Lock")	5-29
Remote Microphone Kill ("RMK")	5-29
Kill Beltpack Microphones ("KILL(BP)")	5-29
Kill Party Line Microphones ("KILL(PL)")	5-29
Kill All Microphones ("KILL(ALL)")	5-30
Battery Indicator ("BATTERY")	5-30

OPERATING THE FREESPEAK WIRELESS BELT- PACK	6-1
Overview of the Wireless Beltpack	6-1
Beltpack Top Control Section	6-2
Talk Knobs, Channels A and B	6-2
Level-Control Lights, Channels A and B	6-3
Talk/Listen Lights, Channels A and B	6-3
Answer-Back Lights	6-3
Combo Button	6-3
Beltpack Front/Display Section	6-4
Backlit LCD Display	6-4

Left and Right Scroll Buttons	6-4
Enter/Answer-Back Button	6-4
Beltpack Batteries	6-5
Beltpack Rear/Battery Section	6-5
Power Button	6-5
Battery Case	6-5
Belt Clip	6-6
Beltpack Bottom Connector Section	6-6
Data Connector	6-6
Headset Connector	6-6
Battery Recharger Connector	6-7
Beltpack Turn-On Sequence	6-7
Beltpack Turn-Off Sequence	6-7
Powering the FreeSpeak Beltpack	6-7
Registering Beltpacks with the Basestation	6-9
Removing Registered Beltpacks from the Basestation	6-10
Accessing the Talk/Listen Paths on the FreeSpeak Beltpack	6-10
Setting and Adjusting Listen Levels	6-11
Headset Limiter	6-12
Using the Beltpack Answer-Back Functions	6-12
Beltpack Menu Options	6-13
Alarm Options	6-13
Low Battery Alarm	6-13
Low Signal Alarm	6-13
Audio Options	6-14
Headphone-Off Level Option	6-14
Page Lock Option	6-14
Headphone Limiter Option	6-14
Microphone Type Option	6-14
Microphone Level Option	6-15
Headset Options	6-15
View Status	6-15
Role Information	6-15
Beltpack Version	6-15
Beltpack ID	6-15
RF Carrier Mask	6-15
Connection Info	6-16
Adjust Contrast	6-16

PROGRAMMING AT THE BELTPACK	7-1
Introduction to Programming on the Beltpack.	7-1
Beltpack Programming - Menu Structure	7-1
Main Programming Menu	7-2
The Alarm Options Menu	7-3
Switching the Low Battery Alarm ON and OFF	7-4
Low Battery Alarm Off	7-4
Low Battery Alarm On1	7-4
Low Battery Alarm On2	7-4
Low Battery Alarm Threshold	7-5
Low Battery Threshold Setup	7-5
Switching the Low Signal Strength Alarm ON and OFF	7-5
The Vibra Call Alert Menu	7-5
The Headphone Menu	7-6
Headset Noise Gate	7-9
The Microphone Menu	7-9
The Status (Information) Menu	7-10
Adjust Contrast	7-13
Set Factory Defaults	7-14
Tap Latch	7-14
Keylock	7-15
PTT Configuration	7-15
Master Volume Control	7-16
Page Options	7-16
Page Locking	7-17

OPERATING THE FREESPEAK TRANS- CEIVER/ANTENNA	8-1
Transceiver/Antenna (FS-TA)	8-1
FS-TA Top Panel	8-1
Omnidirectional Antennas	8-1
FS-TA Bottom/Control Panel	8-2
Serial Data Connector	8-2
Data Signal LED	8-2
Matrix Connector	8-2
Power LED	8-3
DC In Power Connector	8-3
Cabling the FS-TA Transceiver/Antennas	8-3
Beltpack Support Capacities for Transceiver/Antennas	8-3
Coverage Areas Under Various Conditions	8-4

Transceiver/Antenna Setup Rules and Tips	8-4
Transceiver/Antenna Splitter (PD2203)	8-5
PD2203 Front Connector Panel	8-6
Basestation Connection Indicator Light	8-6
Matrix (FreeSpeak Basestation) Connector.	8-6
Splitter-to-Transceiver/Antenna Signal Indicator Light	8-6
Transceiver/Antenna Connectors	8-6
PD2203 Rear Panel	8-7
Serial Data Connector	8-7
Power Indicator	8-7
DC IN Power Connector	8-7
EXP IN Connector	8-7
EXP OUT Connector	8-7
Connecting an Antenna Splitter to the FreeSpeak Basestation and to Transceiver/Antennas.	8-8
INSTALLING A SYSTEM.	9-1
Placing the Basestation	9-1
Placing the Antennas and Splitters	9-1
Wiring the Antennas and Splitters	9-2
Determining Coverage Areas	9-2
Doing a Site Survey to Determine Coverage Areas	9-3
Testing Coverage Areas of Individual Antennas	9-3
Testing Antenna Handoff.	9-5
Getting Information on Active Antenna Status	9-6
Assigning Beltpacks to Coverage Areas	9-7
Conditions Affecting Coverage Areas	9-7
FREESPEAK CONFIGURATION EDITOR	10-1
Introduction	10-1
Loading and Saving Configurations	10-1
Loading a configuration from disk	10-2
COM port selection	10-2
IP Setup	10-2
Retrieving a configuration from a Freespeak basestation via the Serial Link.	10-2
Retrieving a configuration from a Freespeak basestation via Ether- net.	10-4
Help	10-5
Clear Map	10-5
Send File	10-5

Exit	10-5
Uploading configurations Using the Serial Link	10-6
Uploading configurations Using Ethernet	10-6
Belpacks tab	10-7
Selecting the beltpack to register or edit	10-7
Registering beltpacks Using the Serial Link	10-8
The Overview button	10-9
The Set Defaults Button	10-9
Read Beltpack Settings	10-10
Write Beltpack Settings	10-10
Remember My Default Settings	10-10
Recall My Default Settings	10-10
Recall Factory Defaults	10-11
Headset Limiter	10-11
MIC Type	10-11
MIC Gain Level	10-11
MIC Noisegate Level	10-11
Headphone Off Level	10-11
Sidetone Level	10-11
Master Volume	10-11
Menu Level	10-12
Page Change	10-12
Keytap Mode	10-12
RSSI Warning	10-12
Low Battery Warning	10-12
Keylock	10-13
Call Alert	10-13
Assigning beltpack keys	10-13
The Reply key	10-14
Key assignment types	10-15
Latching keys	10-15
On Page Change Cut	10-16
Menu	10-16
Advanced Menu Setting	10-16
Normal Menu Setting	10-16
Basic Menu Setting	10-16
None Menu Setting	10-16
Input and output levels	10-16
Ports tab	10-17
Selecting the port to edit	10-17
Changing the label of the port	10-18

Type drop-down box	10-18
Cross Point assignment drop-down box	10-18
Input and output levels	10-19
Groups tab	10-20
Selecting the group to edit	10-20
Changing the label of the group	10-20
Changing the members of the group	10-20
Group Overview	10-21
Antennas tab	10-21
IFB Tab	10-22
Configuring an IFB	10-22
System Tab	10-24
DECT carriers	10-26
Sys ID	10-26
System Number	10-26
FREESPEAK TOOLKIT	11-1
Introduction	11-1
Configuration Editor	11-1
Basestation Serial Firmware Upgrader	11-1
Beltpack and Antenna Serial Firmware Upgrader	11-1
Diagnostic Program	11-1
Toolkit Installation	11-1
Beltpack Registration	11-7
Entering beltpack serial numbers into the basestation	11-7
Entering the basestation system ID into the beltpack	11-7
Basestation Serial Upgrader	11-8
Upgrading the basestation firmware	11-8
Beltpack Serial Upgrader	11-11
Installing the Beltpack Upgrader	11-11
Running the Beltpack Upgrader	11-13
Basestation Programming Serial Cable Pinout	11-14
Beltpack Programming Serial Cable Pinout	11-15
SPECIFICATIONS	12-1
Notice about Specifications	12-4

GLOSSARY	13-1
APPENDIX A: DECT CARRIER FREQUENCY CHART A-1	
APPENDIX B: PROGRAMMING MENUS	B-1
LIMITED WARRANTY	W-I
TECHNICAL SUPPORT & REPAIR POLICY.....	W-V
TECHNICAL SUPPORT POLICY.....	W-v
RETURN MATERIAL AUTHORIZATION POLICY	W-vi
REPAIR POLICY	W-viii

FIGURES

Figure 1-1 A FreeSpeak Antenna, Beltpack, and Basestation	1-1
Figure 1-2 A FreeSpeak Digital Wireless Communication System..	1-3
Figure 1-3 Configurations for a Studio and Large-Scale Broadcast Facility	1-4
Figure 1-4 Default Map Loaded	1-5
Figure 1-5 Beltpack Configuration with the Default Map	1-6
Figure 2-1 Connect the FreeSpeak Basestation to the Wired Devices .	2-2
Figure 2-2 Clear the Basestation's Memory and Enable the Party Line	2-3
Figure 2-3 Overview of Beltpack Operation	2-4
Figure 3-1 FreeSpeak Basestation Front Panel	3-2
Figure 4-1 FreeSpeak Basestation Back Panel	4-1
Figure 4-2 VOX Gating Level on Party Line Connection	4-8
Figure 4-3 VOX Gate Setting Examples	4-9
Figure 4-4 Wireless Party Line Audio Flow	4-10
Figure 4-5 Front View of RJ-45 Connector	4-11
Figure 4-6 IFB Audio Path	4-15
Figure 4-7 Powering an Antenna Splitter	4-21
Figure 5-1 Initial Password Request Display	5-3
Figure 5-2 System Password Menu	5-3
Figure 5-3 System Password Entry	5-3
Figure 5-4 From the MAIN menu, select BELTPACKS	5-4
Figure 5-5 Available Beltpacks Menu	5-4
Figure 5-6 First Beltpack Programming Options Menu	5-4
Figure 5-7 Second Beltpack Programming Menu	5-5
Figure 5-8 Editing a Beltpack's Label	5-5
Figure 5-9 Select "Ports" from the Main Menu	5-6
Figure 5-10 First Available Ports Menu	5-6
Figure 5-11 Second Available Ports Menu	5-6
Figure 5-12 Port Programming Options Menu	5-6
Figure 5-13 Editing a Port's Label	5-7
Figure 5-14 Standard Group Labels	5-8
Figure 5-15 Wireless Party Line Group Labels	5-8
Figure 5-16 Select Label from the Menu	5-8
Figure 5-17 Group Name Edit Menu	5-8
Figure 5-18 Group Programming Options Menu	5-10
Figure 5-19 Adding Members to a Group	5-10
Figure 5-20 First Beltpack Menu	5-11
Figure 5-21 Second Beltpack Menu	5-11
Figure 5-22 Assign communication routes ("labels") to a beltpack key .	5-12
Figure 5-23 Beltpack Display	5-12
Figure 5-24 Select the source/destination to assign to that beltpack key	5-13
Figure 5-25 Key Type Menu	5-13

Figure 5-26 Beltpack Levels Menu	5-14
Figure 5-27 Beltpack Input Level Setup.....	5-14
Figure 5-28 Beltpack Output Level Setup.....	5-14
Figure 5-29 Beltpack Latching Menu	5-15
Figure 5-30 Beltpack Group Editing Menu.....	5-15
Figure 5-31 Beltpack Groups Selected.....	5-15
Figure 5-32 Labels Selected on the Beltpack Menu	5-16
Figure 5-33 Beltpack Label Editing Menu.....	5-16
Figure 5-34 Beltpack Registration Menu	5-17
Figure 5-35 Available Audio Ports Menu	5-17
Figure 5-36 Selected Port Menu for Level Setting.....	5-18
Figure 5-37 Port Levels Menu	5-18
Figure 5-38 Port Input Level Setup.....	5-18
Figure 5-39 Port Output Level Setup.....	5-18
Figure 5-40 Available Audio Ports Menu	5-19
Figure 5-41 Selected Port Menu for Calls.....	5-19
Figure 5-42 Port Call Menu.....	5-19
Figure 5-43 Port Destination Select Menu.....	5-20
Figure 5-44 Available Audio Ports Menu	5-20
Figure 5-45 Selected Port Menu for Calls.....	5-20
Figure 5-46 Port Call Menu.....	5-20
Figure 5-47 Port Destination Select Menu.....	5-21
Figure 5-48 First Party Line Connection Type Menu	5-22
Figure 5-49 Second Party Line Connection Type Menu.....	5-22
Figure 5-50 Party Line Noisegate Menu	5-23
Figure 5-51 Party Line Noisegate Options Menu.....	5-23
Figure 5-52 Party Line Noisegate Trigger Level	5-23
Figure 5-53 VOX Delay Setup	5-23
Figure 5-54 Level Editing Menu for Party Line	5-24
Figure 5-55 Party Line Input Level.....	5-24
Figure 5-56 Party Line Output Level.....	5-24
Figure 5-57 Party Line LoNULL Level	5-25
Figure 5-58 Party Line HiNULL Level	5-25
Figure 5-59 System Menu 1	5-26
Figure 5-60 System Menu 2	5-26
Figure 5-61 System Menu 3	5-26
Figure 5-62 System Info Menu	5-27
Figure 5-63 Restore Defaults Menu.....	5-27
Figure 5-64 ANTENNAS menu.....	5-27
Figure 5-65 IP Address Menu.....	5-28
Figure 5-66 Lock Enable Menu.....	5-29
Figure 5-67 Remote MIC Kill Menu	5-29
Figure 5-68 Battery Level Menu	5-30
Figure 6-1 Overview of Beltpack Functions	6-1
Figure 6-2 View of Top of Beltpack.....	6-2
Figure 6-3 View of Front of Beltpack	6-4
Figure 6-4 View of Back of Beltpack.....	6-5
Figure 6-5 View of Bottom of Beltpack	6-6
Figure 6-6 Battery Discharge Characteristics	6-8
Figure 6-7 How the beltpack displays its six communication routes.....	

6-10	
Figure 7-1	Connection Information Display 7-12
Figure 8-1	FreeSpeak Transceiver/Antenna..... 8-1
Figure 8-2	FreeSpeak Transceiver/Antenna Bottom/Control Panel 8-2
Figure 8-3	FreeSpeak Splitter Front Connector Panel 8-6
Figure 8-4	FreeSpeak Splitter Rear Connector Panel 8-7
Figure 9-1	A Beltpack's Site Survey Screen..... 9-4
Figure 9-2	Mapping overlapping coverage zones..... 9-5
Figure 9-3	ANTNS menu 9-6
Figure 10-1	Configuration Editor Initial Screen..... 10-1
Figure 10-2	Map Select Screen 10-2
Figure 10-3	Configuration Editor Serial Timeout 10-3
Figure 10-4	Configuration Setup..... 10-3
Figure 10-5	Map Upload Progress..... 10-4
Figure 10-6	Configuration Editor Ethernet Timeout 10-4
Figure 10-7	Configuration Setup..... 10-5
Figure 10-8	Beltpacks Tab..... 10-7
Figure 10-9	Beltpack List 10-7
Figure 10-10	Beltpack Label..... 10-8
Figure 10-11	Registering a Beltpack 10-8
Figure 10-12	Beltpack Serial Number..... 10-9
Figure 10-13	Beltpack Overview..... 10-9
Figure 10-14	Beltpack Defaults Setup 10-10
Figure 10-15	Beltpack Page Number 10-13
Figure 10-16	Beltpack Key Assignments 10-14
Figure 10-17	Input and Output Levels 10-17
Figure 10-18	Ports Tab..... 10-17
Figure 10-19	Party Line Port Type Menu..... 10-18
Figure 10-20	Cross Point List for Port 10-19
Figure 10-21	Party Line Crosspoint Type 10-19
Figure 10-22	Groups Tab 10-20
Figure 10-23	Group Overview Display..... 10-21
Figure 10-24	Antennas Tab..... 10-21
Figure 10-25	Antenna Cable Length Setup 10-22
Figure 10-26	IFB Configuration Tab 10-22
Figure 10-27	IFB Selection List 10-23
Figure 10-28	Dim Level List..... 10-23
Figure 10-29	System Tab 10-24
Figure 10-30	Password Entry 10-24
Figure 10-31	Password Entered 10-25
Figure 10-32	Country Setup 10-25
Figure 11-1	Previous Version Uninstall 11-2
Figure 11-2	Toolkit Install Startup..... 11-3
Figure 11-3	Toolkit Installer Names..... 11-3
Figure 11-4	Toolkit Installation Path 11-4
Figure 11-5	Toolkit Start Menu Setup..... 11-5
Figure 11-6	Toolkit Install Confirm..... 11-6
Figure 11-7	Installation Completion Display 11-6
Figure 11-8	Upgrading Basestation Firmware 11-8
Figure 11-9	Select Firmware File..... 11-9

Figure 11-10 Firmware Download	11-9
Figure 11-11 Download Timeout	11-10
Figure 11-12 Beltpack Upgrader Installation Start.....	11-11
Figure 11-13 Set Installation Directory	11-11
Figure 11-14 Beltpack Upgrader Program Group.....	11-12
Figure 11-15 Installer Version Conflict.....	11-12
Figure 11-16 Installation Completed.....	11-13
Figure 11-17 Beltpack Upgrader Startup	11-13
Figure 11-18 Beltpack Upgrade Progress	11-13
Figure B-1 Programming Menus.....	B-1

TABLES

Table 4-1 Party Line Pinout	4-4
Table 4-2 FreeSpeak Basestation 4-Wire Pinout	4-12
Table 4-3 Pinouts for Connecting to Other Digital Matrix Intercom Systems	4-13
Table 4-4 IFB Key Configurations.....	4-15
Table 4-5 Pin Assignments for Stage Announce Connector	4-16
Table 4-6 Pinout for Cable to Upgrade Basestation Firmware	4-17
Table 4-7 Pinout for Cable to Upgrade Beltpack Firmware	4-18
Table 7-1 Connection Information	7-12
Table 9-1 How antennas are numbered	9-6
Table 11-1 Null-Modem Cable Pinout.....	11-14
Table 11-2 Beltpack Programming Serial Cable Pinout	11-15
Table A-1 DECT Carrier Frequency Chart.....	A-1

IMPORTANT SAFETY INSTRUCTIONS

Please read and follow these instructions before operating a FreeSpeak wireless communication system. Keep these instructions for future reference.

Please read and follow these instructions before operating a FreeSpeak wireless communication system.

(1) WARNING: To reduce the risk of fire or electric shock, do not expose this apparatus to rain or moisture.

(2) Do not use the apparatus near water.

(3) Clean only with a dry cloth.

(4) Do not block any ventilation openings. Install in accordance with the manufacturer's instructions. Install the FreeSpeak wireless communication system according to the directions in the Installation Chapter of this manual.

(5) Do not install near any heat sources such as radiators, heat registers, stoves, or other apparatus (including amplifiers) that produce heat. Do not place naked flame sources such as candles on or near the matrix.

(6) Do not defeat the safety purpose of the polarized plug or grounding-type plug. A polarized plug has two blades with one wider than the other. A grounding-type plug has two blades and a third grounding prong. The wide blade or the third prong are provided for your safety. If the provided plug does not fit into your outlet, consult an electrician for replacement of the obsolete outlet.

(7) Protect power leads from being walked on or pinched particularly at plugs, at convenience receptacles, and at the point where they exit from the apparatus.

Note: A "convenience receptacle" is an extra AC power outlet located on the back of a piece of equipment, intended to allow you to power other equipment.

(8) Only use attachments/accessories specified by the manufacturer.

(9) Use only with the cart, stand, tripod, bracket, or table specified by the manufacturer, or sold with the apparatus. When a cart is used, use caution when moving the cart/apparatus combination to avoid injury from tip-over.

(10) Unplug the apparatus during lightning storms or when unused for long periods of time.

(11) Refer all servicing to qualified service personnel. Servicing is required when the apparatus has been damaged in any way, such as a power-supply cord or plug is damaged, liquid has been



spilled or objects have fallen into the apparatus, the apparatus has been exposed to rain or moisture, does not operate normally, or has been dropped.

(12) The FreeSpeak wireless communication system contains a non-user serviceable battery.

CAUTION: Danger of explosion if battery is incorrectly replaced. Replace only with the same or equivalent type.

Lithium batteries can overheat or explode if they are shorted. When you handle the CPU card or a loose battery, DO NOT touch any external electrical conductors to the battery's terminals or to the circuits that the terminals are connected to.

Please familiarize yourself with the safety symbols in Figure 1. When you see these symbols on a FreeSpeak wireless communication system, they warn you of the potential danger of electric shock if the system is used improperly. They also refer you to important operating and maintenance instructions in the manual.



This symbol alerts you to the presence of uninsulated dangerous voltage within the product's enclosure that might be of sufficient magnitude to constitute a risk of electric shock. Do not open the product's case.



This symbol informs you that important operating and maintenance instructions are included in the literature accompanying this product.

Safety Symbols

A SA

The FreeSpeak wireless communication system meets all relevant CE, FCC, UL, and CSA specifications set out below:

EN55103-1 Electromagnetic compatibility. Product family standard for audio, video, audio-visual, and entertainment lighting control apparatus for professional use. Part 1: Emissions.

EN55103-2 Electromagnetic compatibility. Product family standard for audio, video, audio-visual, and entertainment lighting control apparatus for professional use. Part 2: Immunity.

BS EN 60065:2002 Audio, video, and similar electronic apparatus. Safety requirements.

And thereby compliance with the requirement of Electromagnetic Compatibility Directive 89/336/EEC and Low Voltage Directive 73/23/EEC as amended by 93/68/EEC.

This device complies with Part 15 of the FCC Rules. Operation is subject to the following two conditions: (1) this device may not cause harmful interference, and (2) this device must accept any interference received, including interference that may cause undesired operation.

1

GETTING STARTED: AN INTRODUCTION TO FREESPEAK

With a FreeSpeak wireless beltpack users can roam freely around a studio or production facility while talking and listening to all, or selected, members of the production team. With its six communication routes, the beltpack gives users the flexibility to communicate quickly and seamlessly with individuals or groups, and to change communication routes as often as needed.

A FreeSpeak system consists of three basic elements: the basestation, wireless beltpack, and antenna.

The award-winning FreeSpeak® technology, the world's first wireless system to include local route programming, crosspoint level control, groups, and full non-blocking mixing facilities.

The system operates in the unlicensed 1.90 GHz band. With its unique and innovative digital technology, which continually searches for unused radio frequency (RF) channels, FreeSpeak avoids the noise and interference issues associated with traditional wireless systems using congested UHF and VHF bands.

With the basic three elements the user can design a digital wireless system for specific requirements.



Figure 1-1: A FreeSpeak Antenna, Beltpack, and Basestation

FreeSpeak allows a wireless system to be set up specifically tailored to local needs by locating antennas and beltpacks in areas where they are needed most. And because the beltpacks operate in the unlicensed 1.90 GHz frequency spectrum, there is no interference with existing wireless systems, even those located in the same production area.

FreeSpeak may be used stand-alone or connected with party-line and/or digital matrix intercom systems. The basestation holds

The FreeSpeak basestation functions as a full-duplex digital matrix switcher and router for voice communications.

Each antenna can support communications with up to five wireless beltacks operating within its coverage zone.

connections for several wired interfaces, including party lines, 4-wire sources, a program audio source, and a stage announce output device. When wired to the basestation, these devices communicate seamlessly with the wireless beltacks. Party-line beltacks and 4-wire matrix stations and panels can key directly to wireless beltack by name.

FREESPEAK FEATURES

Features of FreeSpeak include:

- Basestation in one rack unit (1 RU).
- Up to twenty wireless beltacks.
- Point-to-point and small group wireless communications.
- Up to six communication routes per beltack.
- Party-line beltacks, 4-wire devices, program audio source, and stage announce output seamlessly included in communication system.
- IFB functionality with up to five IFB audio sources configurable on the basestation.
- Up to five standard groups configurable on the basestation.
- Up to five wireless party line groups configurable on the basestation.
- Up to ten remote transceiver/antennas create custom coverage zones.
- Transceiver/antennas can be located up to 1,000 meters (3,200 feet) using 24 AWG cable or up to 500 meters (1,600feet) using 26 AWG cable over CAT-5 cable from the basestation avoiding expensive RF cable.

Note: It is recommended that shielded CAT-5 cable is used for all FreeSpeak installation.

- Five-character labels for each beltack and wired connection.
- Communication groups can be created, customized, and assigned to beltack keys.
- License-free operation in the 1.90 GHz band—above television and other wireless communications.
- Frequency-hopping DECT technology automatically finds clear spectrum.
- Base functions like a digital matrix; each beltack has a “virtual port” timeslot.
- Secure system—beltacks are registered to a particular base and can frequency hop.

- Two bases can connect locally via 4 wire ports or Party-lines only.

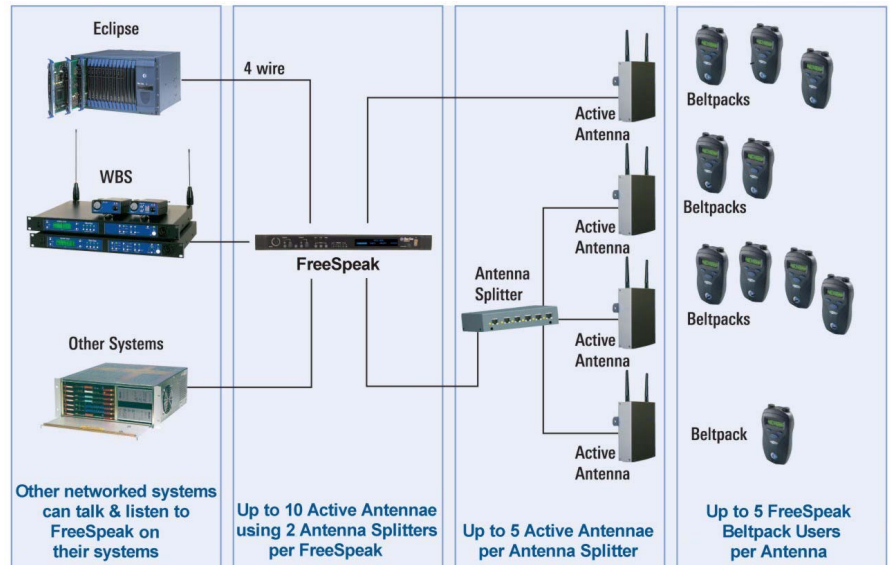

Figure 1-2: A FreeSpeak Digital Wireless Communication System

A FREESPEAK COMMUNICATION SYSTEM

A FreeSpeak system consists of three basic elements:

- The wireless beltpacks.
- The basestation that routes communication to and from wireless beltpacks and other audio devices.
- The transceiver/antennas that provide custom coverage zones in which four to five beltpacks can operate. Beltpacks can roam freely between coverage zones.

FreeSpeak operates using a cellular network of antennas located around a working environment. The antennas connect directly to the FreeSpeak basestation with CAT-5 cable. Each antenna provides an area or "cell" in which four to five full-duplex beltpacks can operate. Figure 1-2 above shows an example configuration.

Beltpacks can roam among and between cells without dropping off because each antenna continually signals a beltpack as to the strongest available signal. When the signal from an antenna starts to diminish due to the distance from a beltpack, the beltpack automatically "hands off" its signal to the nearest antenna, ensuring smooth transfer.

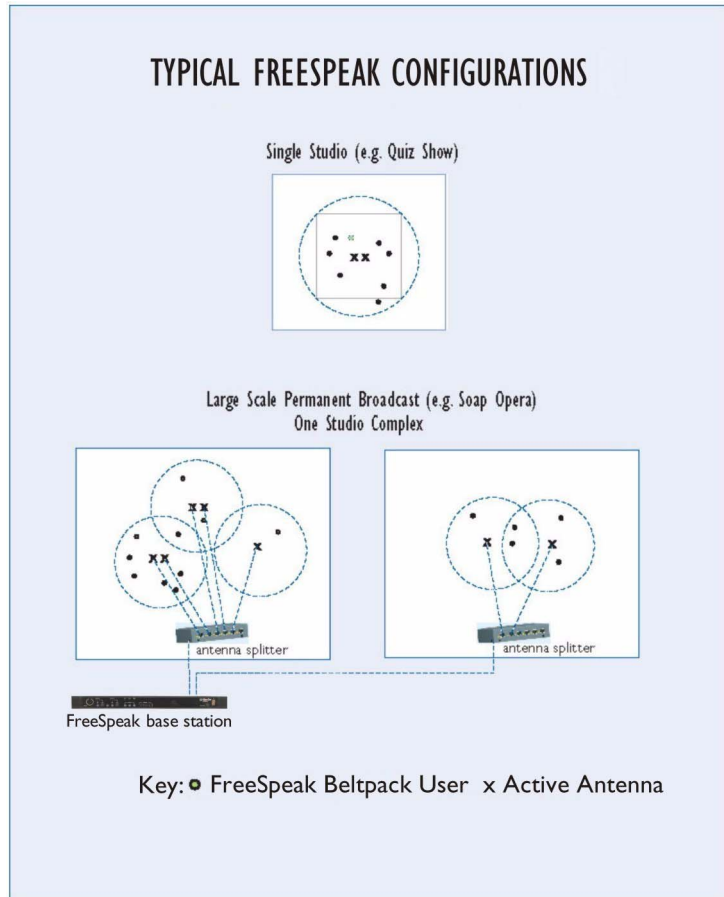

Figure 1-3: Configurations for a Studio and Large-Scale Broadcast Facility

Using an antenna splitter allows up to five antennas to be connected to one base-station antenna port. A single FreeSpeak basestation supports up to twenty beltpacks and up to ten antennas, giving a great deal of flexibility in placing beltpacks where they are needed most, and for providing wireless reliability. Figure 1-3 illustrates how a FreeSpeak system can be set up to operate in a single studio or in a large-scale permanent broadcast facility.

Note: Each antenna is designed to handle five beltpacks simultaneously in good conditions. However, if interference or propagation problems occur in an area, to ensure proper operation and reliability, it may be more practical to install four beltpacks for each antenna.

For zones which are likely to need coverage for five or more beltpacks simultaneously it is recommended that a second antenna is installed. Similarly, for good coverage for nine or more beltpacks simultaneously, a third antenna may be required.

IMPORTANT INSTALLATION INFORMATION

System Password

From release V2.0 onwards FreeSpeak basestations require a password to be input in order to activate the basestation when it is first configured. The password requires the unique basestation system ID and will normally be supplied with the installation CD for a new unit. If an existing basestation is upgraded the basestation system ID must be provided before an upgrade CD can be supplied.

Default Map

In V2.0 a default map has been added to help the first time user; the map is designed to work like a simple party-line system.

Note that the analogue party-line ports are not included in the default map as they would introduce an echo into the audio.

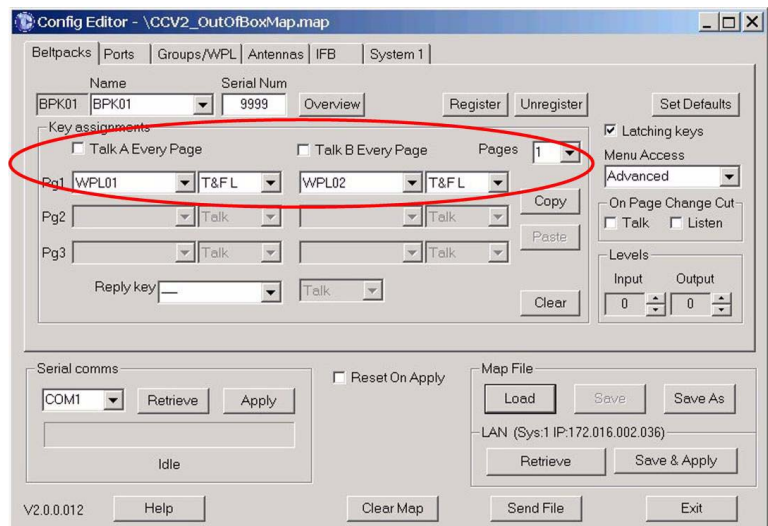

Figure 1-4: Default Map Loaded

The Figure 1-4 above shows the default map on the configuration editor; the two WPL (wireless party-lines) are programmed on the first page and the other page are left un-programmed and will not be shown on the beltpack.

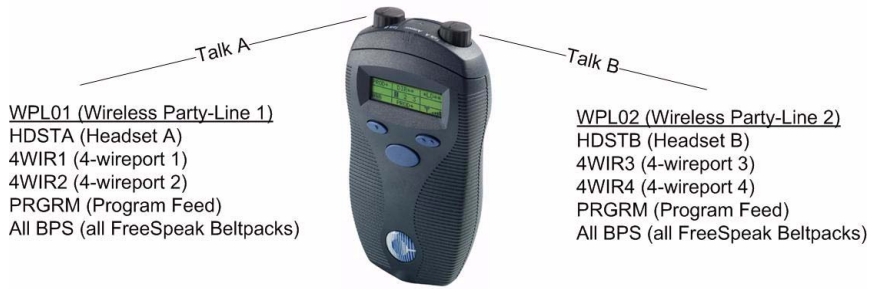

Figure 1-5: Beltpack Configuration with the Default Map

Figure 1-5 shows how each beltpack key will be configured by the default map.

2

QUICK START

The following exercise demonstrates how to set up a simple configuration of wired and wireless devices in a FreeSpeak system. The user should have some familiarity with how FreeSpeak operates before attempting this exercise. If not, please read through the manual first, and then do the exercise.

To complete the exercise the following equipment will be needed. The goal is to establish communication between these devices:

- A FreeSpeak system including two wireless beltacks, an antenna, and a basestation.
- A 4-wire audio source, such as an Eclipse matrix.
- A wired beltack, such as a Clear-Com 501 or 601 beltack.

Specifically, this quick-start exercise shows how to:

- Wire the FreeSpeak basestation to a party-line beltack, a 4-wire audio source, and a FreeSpeak antenna.
- Assign labels to two FreeSpeak beltacks.
- From the FreeSpeak basestation, create a group containing the wired and wireless devices.
- Initiate calls between members of the group.

Note: For a quick overview of the FreeSpeak programming menus, refer to Appendix 2.

This exercise demonstrates how to set up a simple configuration.

In this exercise establish communication between a group of wired and wireless devices.

CONNECTING THE BASESTATION

To connect the FreeSpeak basestation to a party-line beltack

1. Make sure the FreeSpeak basestation is powered off.
2. Connect an XLR cable from the “PL CH-A” connector on the rear of the FreeSpeak basestation to a wired party-line beltack, such as an RS-601 (connection 1). See Figure 2-1 for an illustration.

Note: Externally powered party-line equipment, FreeSpeak splitters, and FreeSpeak active antennas should always be connected and powered up before powering the FreeSpeak basestation.

To Connect the FreeSpeak Basestation to a 4-wire matrix port

1. Connect a CAT-5 cable from the FreeSpeak basestation’s leftmost 4-wire audio port (labeled “4-Wire/Eclipse Ports”) to an external 4-wire audio source, such as an Eclipse matrix port (connection 2). See Figure 2-1 for an illustration (shielded CAT-5 is recommended).

Always power up external party-line equipment, FreeSpeak splitters, and FreeSpeak active antennas before powering the FreeSpeak basestation.

To Connect the FreeSpeak Basestation to an Antenna

1. Connect a CAT-5 cable from transceiver port 1 on the FreeSpeak basestation's rear panel to a FreeSpeak antenna (connection 3). See Figure 2-1 for an illustration (shielded CAT-5 is recommended).
2. Power up the basestation.
3. Power up the beltpacks.

If the beltpacks do not connect to the basestation within 30 seconds, check that they are registered to the basestation. If they are not, refer to the chapter "FreeSpeak Configuration Editor" for instructions on registering the beltpacks to the basestation.

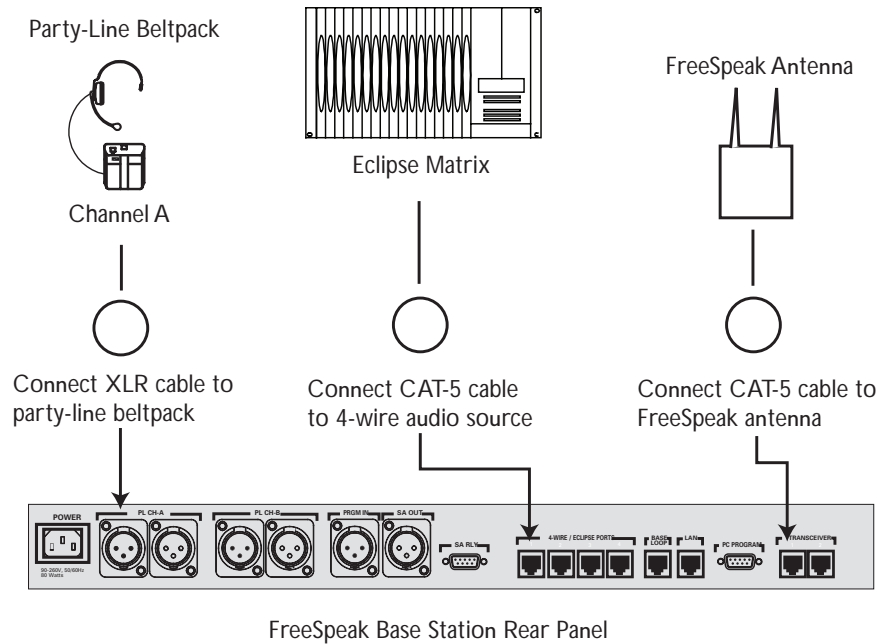

Figure 2-1: Connect the FreeSpeak Basestation to the Wired Devices

4. To get the FreeSpeak into a "clean" state for the example below, from the basestation's front-panel display, scroll to and select PORTS, then 4WIR1, then CALLS, then NONE (NONE is the last element in the list.). Then also select PORTS, then PLCHA, then CALLS, then NONE (See Figure 2-2).

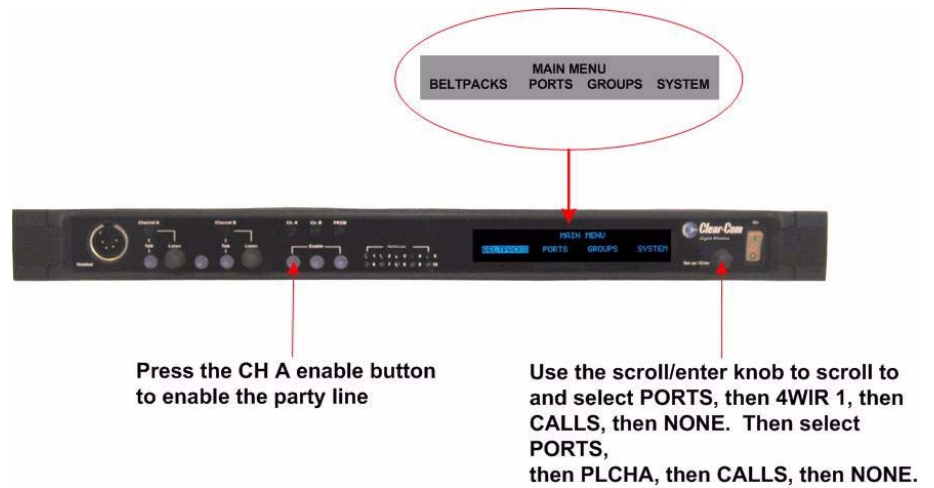

Figure 2-2: Clear the Basestation's Memory and Enable the Party Line

5. Enable the party line by pressing the CH A enable button on the base station's front panel until the CH A enable light illuminates (See Figure 2-2). Auto-nulling should be performed after the party line circuit is connected. Pressing and holding the enable button activates the auto-nulling.

Note: Be aware that a loud tone is generated in the party-line belt-pack's headset during auto-nulling. This tone enables the basestation to perform auto-nulling of the party line.

OVERVIEW OF BELTPACK OPERATION



Figure 2-3: Overview of Beltpack Operation

ASSIGNING LABELS TO THE FREESPEAK BELTPACKS

To assign a name (“label”) to FreeSpeak beltpack #1

1. From the basestation’s front-panel display, use the setup/enter knob to select BELTPACKS, then BPK01, and then LABEL.
Rotate the setup/enter knob until the desired item is highlighted.
Press the knob in to select the item.
2. Rotate the setup/enter knob again to select the alphanumeric character to be edited, then push the setup/enter knob in to select

- the character. Rotate the knob to select the character to replace it with. Press the knob in to select the new character.
3. When selecting characters for the beltpack's item label is complete press the setup/enter knob again to save.
 4. To exit the menu, select and then deselect (by pressing the knob again) the fifth character in the menu.
 5. The changes are saved and applied automatically five seconds after the last time the setup/enter knob is pressed or turned. The front-panel display flashes to indicate that the changes are being saved and applied.
 6. Repeat this entire process for the second wireless beltpack, BPK02.

CREATING A GROUP

To create a group

1. From the basestation's front panel, use the setup/enter knob to scroll to and select GROUPS, then GP#01, then MEMBERS.
If entries in the MEMBERS menu are already in the group these menu entries are outlined. An outline around a menu entry means that it is a member of the group. When an item is selected an outline appears around it. When the item is selected again, the outline disappears.
2. Select the following members of the group: 4WIR1, PLCHA, BPK01, BPK02, so that only these entries are outlined.
3. To exit the Group Members menu, scroll to and select BACK from the basestation's front-panel menu.
4. The changes are saved and applied automatically five seconds after the last time the setup/enter knob was pressed or turned. The front-panel display flashes to indicate that the changes are being saved and applied.

ASSIGNING THE GROUP LABEL TO FREESPEAK BELTPACK KEYS

The next step is to assign the group label created in the previous step, GP#01, to the first key of each of the FreeSpeak wireless beltpacks.

To assign the group label to the first key of FreeSpeak beltpack #1

1. From the basestation's front-panel menu select BELTPACKS, then BPK01, then KEYS. A list will be displayed showing how the 3 pages of 2 keys are currently assigned on beltpack #1.
2. Select "Pg1-1" to edit the first key of the first page. A list of destinations will be displayed this key can be assigned to. Rotate the setup/enter knob clockwise until "GP#01" is highlighted, then press the knob to select it. The basestation's display should display the key options.
 - TLK - talk key

- LIS - listen key
 - T+L - talk and listen key
 - DTL - dual talk and listen key
 - FL - forced listen key
 - TFL - talk and forced listen key
3. Select DTL using the setup/enter knob and press the knob to select it.
 4. Select BACK, then BACK again to return to the list of beltpacks.
 5. The changes are saved and applied automatically five seconds after the last time the setup/enter knob was pressed or turned. The front-panel display flashes to indicate that the changes are being saved and applied.
 6. Repeat the procedure for beltpack #2.

CALLING THE GROUP FROM THE BELT-PACKS

To call the group from beltpack #1

1. If beltpack #1 is not set to page #1 (indicated by the numbers in the center of the display), use the beltpack's left and right scroll buttons to move to page 1.
The label under the left-hand rotary controller should now read GRP01.
2. If the key is programmed to DTL on the basestation press the rotary controller briefly to latch the listen path to "on" or press and hold the rotary controller to talk.
 - The red talk light and green listen light next to the rotary controller should light.
 - If the path is latched to Listen pressing and releasing the rotary controller will delete the path and the red and green lights will extinguish.
 - If the rotary controller is being held to create a talk path releasing it will delete the path. The red and green lights will be extinguished when the talk path is deleted.
 - **Examine the wired beltpack attached to party-line channel A.** It should be possible to hear audio from beltpack #1 in the wired beltpack's headset. If the microphone of the wired beltpack is opened the wireless beltpack should also be able to hear the audio.
 - **The 4-wire device should have 2-way audio.** The wireless beltpack should be able to hear audio from the 4-wire device, and the 4-wire device should be able to hear audio from the wireless beltpack.

- **Examine wireless beltpack #2.** If it is on page #1, the green (listen) light should be flashing and it should be possible to hear audio from beltpack #1. At this point, beltpack #1 won't be able to hear audio from beltpack #2.
3. Press the leftmost rotary knob on beltpack #2, which is next to the flashing green light.
All stations are able to hear beltpack #2 as well as beltpack #1. In other words, all stations can hear each other.
 4. Press the leftmost rotary controllers on beltpacks #1 and #2 briefly to unlatch them. This deactivates all talk and listen paths.

CALLING THE GROUP FROM THE 4-WIRE AUDIO DEVICE

1. From the basestation's front-panel menu, select PORTS, then 4WIR1, then CALLS, then GP#01.
The changes are saved and applied automatically five seconds after the last time the setup/enter knob was pressed or turned. The front-panel display flashes to indicate that the changes are being saved and applied.
 - All stations should now be able to hear the audio coming in from the 4-wire device.
 - On the two wireless beltpacks, the green (listen) lights should be flashing, indicating an incoming call to group #1 from a member of group #1.
2. Note that if the basestation is power cycled off and on again, the talk paths from the 4-wire device are automatically re-established to the wired beltpack and to the two wireless beltpacks.
3. It is possible to remove the talk paths from the 4-wire device to the wired beltpack and to the two wireless beltpacks by selecting PORTS, then 4WIR1, then CALLS, then NONE, from the basestation's front-panel menu.
4. Note that if the calling 4-wire port is included in the group that is being called from the 4-wire device the 4-wire audio will not be looped back to itself.

CALLING THE GROUP FROM THE WIRED PARTY-LINE BELTPACK

1. From the basestation's front-panel menu, select PORTS, then PLCHA, then CALLS, then GP#01.
The changes are saved and applied automatically five seconds after the last time the setup/enter knob was pressed or turned. The front-panel display flashes to indicate that the changes are being saved and applied.
2. After a few seconds, when the wireless beltpacks reconnect, talk from the wired beltpack's microphone.

- Audio from the wired beltpack should be audible on the two wireless beltpacks, and on the 4-wire audio device.

On the wireless beltpacks, the green (listen) light should be flashing, indicating an incoming call to group #1 from a member of group #1.

- Audio from the 4-wire audio device will be audible from the wired beltpack's headset.
3. If the basestation is powered down and then up again, the talk paths from the wired beltpack (on party-line channel A) are re-established to the 4-wire device and to the two wireless beltpacks.
 4. It is possible to remove the talk paths from the wired beltpack's party line to the other devices by selecting PORTS, then PLCHA, then CALLS, then NONE. This may also be done by disabling the party line from the front panel of the FreeSpeak basestation by using the CH A and CH B enable buttons provided that the party line is powered from the basestation as this will remove the power rather than the audio. It will not remove the talk paths if the party line is externally powered.

CREATING A WIRELESS PARTY LINE

To create a wireless party line

1. From the basestation's front panel, use the setup/enter knob to scroll to and select GROUPS, then WP#01, then MEMBERS. If entries in the MEMBERS menu are already in the wireless party line these menu entries are outlined. An outline around a menu entry means that it is a member of the wireless party line. When an item is selected an outline appears around it. When the item is selected again, the outline disappears.
2. Select the following members of the wireless party line: 4WIR1, PLCHA, BPK01, BPK02, so that only these entries are outlined.
3. To exit the Wireless Party Line Members menu, scroll to and select BACK from the basestation's front-panel menu.
4. The changes are saved and applied automatically five seconds after the last time the setup/enter knob was pressed or turned. The front-panel display flashes to indicate that the changes are being saved and applied.

ASSIGNING THE WIRELESS PARTY LINE LABEL TO FREESPEAK BELTPACK KEYS

The next step is to assign the wireless party line label created in the previous step, WP#01, to the first key of each of the FreeSpeak wireless beltpacks.

To assign the wireless party line label to the first key of FreeSpeak beltpack #1

1. From the basestation's front-panel menu select BELTPACKS, then BPK01, then KEYS. A list will be displayed showing how the 3 pages of 2 keys are currently assigned on beltpack #1.
2. Select "Pg1-1" to edit the first key of the first page. A list of destinations will be displayed this key can be assigned to. Rotate the setup/enter knob clockwise until "WP#01" is highlighted, then press the knob to select it. The basestation's display should display the key options.
 - TLK - talk key
 - LIS - listen key
 - T+L - talk and listen key
 - DTL - dual talk and listen key
 - FL - forced listen key
 - TFL - talk and forced listen key
3. Select DTL using the setup/enter knob and press the knob to select it.
4. Select BACK, then BACK again to return to the list of beltpacks.
5. The changes are saved and applied automatically five seconds after the last time the setup/enter knob was pressed or turned. The front-panel display flashes to indicate that the changes are being saved and applied.
6. Repeat the procedure for beltpack #2.

CALLING THE WIRELESS PARTY LINE FROM THE BELTPACKS

To call the wireless party line from beltpack #1

1. If beltpack #1 is not set to page #1 (indicated by the numbers in the center of the display), use the beltpack's left and right scroll buttons to move to page 1.

The label under the left-hand rotary controller should now read WPL01.
2. If the key is programmed to DTL on the basestation press the rotary controller briefly to latch the listen path to "on" or press and hold the rotary controller to talk.
 - The red talk light and green listen light next to the rotary controller should light.
 - If the path is latched to Listen pressing and releasing the rotary controller will delete the path and the red and green lights will extinguish.
 - If the rotary controller is being held to create a talk path releasing it will delete the path. The red and green lights will be extinguished when the talk path is deleted.

- **Examine the wired beltpack attached to party-line channel A.** It should be possible to hear audio from beltpack #1 in the wired beltpack's headset. If the microphone of the wired beltpack is opened the wireless beltpack should also be able to hear the audio.
 - **The 4-wire device should have 2-way audio.** The wireless beltpack should be able to hear audio from the 4-wire device, and the 4-wire device should be able to hear audio from the wireless beltpack.
 - **Examine wireless beltpack #2.** If it is on page #1, the green (listen) light should be flashing and it should be possible to hear audio from beltpack #1. At this point, beltpack #1 won't be able to hear audio from beltpack #2.
3. Press the leftmost rotary knob on beltpack #2, which is next to the flashing green light.
All stations are able to hear beltpack #2 as well as beltpack #1. In other words, all stations can hear each other.
 4. Press the leftmost rotary controllers on beltpacks #1 and #2 briefly to unlatch them. This deactivates all talk and listen paths.

CALLING THE WIRELESS PARTY LINE FROM THE 4-WIRE AUDIO DEVICE

1. From the basestation's front-panel menu, select PORTS, then 4WIR1, then CALLS, then WP#01.
The changes are saved and applied automatically five seconds after the last time the setup/enter knob is pressed or turned. The front-panel display flashes to indicate that the changes are being saved and applied.
 - All stations should now be able to hear the audio coming in from the 4-wire device.
 - On the two wireless beltpacks, the green (listen) lights should be flashing, indicating an incoming call to wireless party line #1 from a member of wireless party line #1.
2. Note that if the basestation is power cycled off and on again, the talk paths from the 4-wire device are automatically re-established to the wired beltpack and to the two wireless beltpacks.
3. It is possible to remove the talk paths from the 4-wire device to the wired beltpack and to the two wireless beltpacks by selecting PORTS, then 4WIR1, then CALLS, then NONE, from the basestation's front-panel menu.
4. Note that if the calling 4-wire port is included in the wireless party line that is being called from the 4-wire device the 4-wire audio will not be looped back to itself.

CALLING THE WIRELESS PARTY LINE FROM THE WIRED PARTY-LINE BELTPACK

1. From the basestation's front-panel menu, select PORTS, then PLCHA, then CALLS, then WP#01.

The changes are saved and applied automatically five seconds after the last time the setup/enter knob is pressed or turned. The front-panel display flashes to indicate that the changes are being saved and applied.
2. After a few seconds talk from the wired beltpack's microphone.
 - Audio from the wired beltpack should be audible on the two wireless beltpacks, and on the 4-wire audio device.

On the wireless beltpacks, the green (listen) light should be flashing, indicating an incoming call to wireless party line #1 from a member of wireless party line #1.
 - Audio from the 4-wire audio device will be audible from the wired beltpack's headset.
3. If the basestation is powered down and then up again, the talk paths from the wired beltpack (on party-line channel A) are re-established to the 4-wire device and to the two wireless beltpacks.
4. It is possible to remove the talk paths from the wired beltpack's party line to the other devices by selecting PORTS, then PLCHA, then CALLS, then NONE. This may also be done by disabling the party line from the front panel of the FreeSpeak basestation by using the CH A and CH B enable buttons provided that the party line is powered from the basestation as this will remove the power rather than the audio. It will not remove the talk paths if the party line is externally powered.

3

OPERATING THE FREESPEAK BASESTATION

INTRODUCTION

The FreeSpeak basestation provides all of the intelligence and signal routing for the FreeSpeak digital wireless intercom system. The basestation is effectively a full-duplex digital matrix communications system, with virtual “ports” for the wireless beltpacks rather than physical ports.

In its memory, the basestation contains all of the labels and communications paths assigned to each FS-BP beltpack, and this information is sent to the beltpacks via the FS-TA transceiver/antennas as soon as they are switched on and recognized by the base.

The basestation also functions as the interface between wired and wireless communication devices. The two party-line intercom connectors, four 4-Wire connectors, and program input/stage-announce output each have their own full-duplex time slot. They can be labeled, added to communication groups, and assigned to beltpacks as desired. Additionally the program input or one of the four 4-Wire connections can be assigned as IFB sources on the basestation.

UNDERSTANDING FRONT-PANEL OPERATION



Figure 3-1: FreeSpeak Basestation Front Panel

① Headset Connector

The 4-pin male XLR-type headset socket connects to Clear-Com headsets and other headsets with 4-pin female connectors. This headset connector is for the onboard two-channel intercom, with controls just to the right of the connector.

② & ③ Channel A Talk Switch and Light/Listen Level Knob

The channel A talk switch and associated light, and listen level knob, allow full-duplex conversations with any FreeSpeak wireless beltpacks or other communications systems wired to the rear of the basestation to which the onboard Channel A has been assigned. Assignments are done via the front-panel programming.

The talk switch is momentary/latching, such that pressing it and holding down will create a talk path that ends when the user releases the switch, while quickly tapping it will latch the talk, and a second tap will release it. The LED lights red when a talk is active.

Turning the listen level knob clockwise will allow the user to hear the other party's voice, increasing the level to maximum when fully clockwise.

The audio level is shown on the beltpack screen next to the battery display.

④ A/B Reply Button

Pressing this button will reply to the last caller to call A or B.

⑤ & ⑥ Channel B Talk Switch and Light/Listen Level Knob

The channel B talk switch and associated light, and listen level knob, function the same as the controls for Channel A.

⑦ Party Line Channels A and B Enable Switches

The channel A and channel B enable switches and associated lights activates the power only on the rear-panel to party-line intercom channels A and B. Activating one or both of these switches enables the power to that party line but does not affect the audio to the party line which is always connected. These switches may be “locked” via the front-panel SYSTEM programming menu so that they may not be disengaged accidentally.

If the button is held in for more than 8 seconds autonulling mode will be enabled for the current party line and the following message will be displayed:

“Release button to begin autonulling”

When the button is release the basestation will perform an autonulling on the current party line. On completion the following message will be displayed:

“Party line A Autonulling complete”

for party line A.

⑧ Program Audio Enable Switch and Light

This latching switch makes any program audio signal that enters via the rear-panel line-level 3-pin XLR connector available to be assigned to wireless beltpacks, either separately or mixed with communications groups. This switch may be “locked” via the front-panel SYSTEM programming menu so that it may not be disengaged accidentally.

⑨ Antenna Light Display

These green LEDs, one for each of the ten antennas that the base will support, light when an antenna is connected and ready.

⑩ Display Screen

The display screen shows all of the menus and programming options that are available within the FreeSpeak system. The user can select a particular beltpack and view all of its current talk/listen assignments, or see all of the current members of a particular group. Via the screen and rotary encoder, labels (5-character user names) can be created and/or changed, new members assigned to groups, input and output levels adjusted, and so on.

⑪ Setup/Enter Knob

The setup/enter knob is used to scroll through the various menu options within the FreeSpeak basestation, in order to discover specific information regarding users or to program communications routes and groups. Turning the knob clockwise scrolls display items toward the right, and turning the knob counterclockwise scrolls display items toward the left.

When a desired menu item is highlighted, pushing the setup/enter knob inward will select that item. The lists of available beltpacks and groups typically span two or more screens, so when the highlight is at the leftmost or rightmost part of the screen and the user continues to turn the rotary encoder in that direction, the display will jump to the next screen selections (Example: in the beltpack sections, the first screen shows beltpacks 1 through 5, and the second shows 6 through 10.)

Pressing and holding the Setup/Enter knob for more than three seconds will return the display to the battery monitor.

⑫ Power Switch

The power switch will turn the FreeSpeak basestation on and off.

4

CONNECTING THE FREESPEAK BASESTATION

The FreeSpeak basestation connects to several wired interfaces that can communicate with the wireless beltpacks.

The FreeSpeak basestation connects to the following wired interfaces through its rear-panel connectors:

- Basestation to AC power
- Basestation to party-line channels A and B
- Basestation to program audio source
- Basestation to stage announce output
- Basestation to stage announce relay
- Basestation to 4-wire matrix ports
- Basestation to a second basestation (not used)
- Basestation to a PC
- Basestation to transceiver antennas

UNDERSTANDING THE BACK-PANEL CONNECTORS

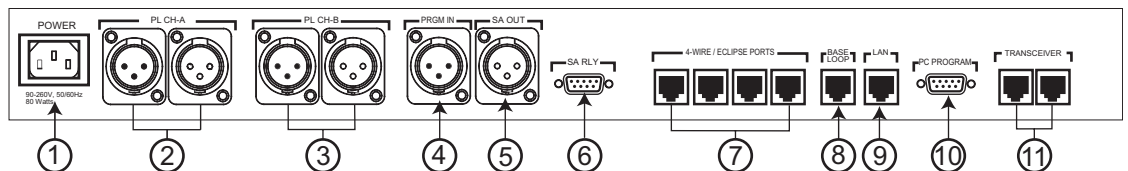

- | | |
|-------------------------------------|------------------------------------|
| 1 - Power Connector | 7 - 4-Wire Matrix Ports |
| 2 - Party Line Channel A Connectors | 8 - Base Loop Connector (not used) |
| 3 - Party Line Channel B Connectors | 9 - LAN Connector |
| 4 - Program Input | 10 - PC Connector |
| 5 - Stage Announce Output | 11 - Transceiver Connectors |
| 6 - Stage Announce Relay | |

Figure 4-1: FreeSpeak Basestation Back Panel

① IEC Power Connector

The 3-conductor AC power connector and universal power supply accepts voltages from 90 to 250 volts, at 50/60 Hz. Power consumption is 80 watts.

② Party Line Channel A Connectors

The FreeSpeak basestation provides two pairs of party-line connectors, labeled “Channel A” and “Channel B.” Each pair of female and male 3-pin XLR connectors joins a channel of party-line intercom to the FreeSpeak, allowing communication between the wired party-line equipment and FreeSpeak wireless beltacks. Input and Output level control is set via the front-panel display programming.

The second connector of each pair is a loop-through, so that the user can continue the connection to another FreeSpeak basestation or to another party-line beltack or station. This connector auto-detects a connection with a powered party-line channel (30-VDC on Pin 2), and the basestation’s internal 200-ohm party-line termination and DC voltage to power PL beltacks is not activated.

Alternatively, when a wired, unpowered party-line beltack (up to four) is connected to PL CH-A with standard two-conductor shielded microphone cable, the basestation engages the 200-ohm termination and supplies 24-VDC to the beltack(s) – allowing them to operate and communicate with the wireless beltacks in the system.

③ Party Line Channel B Connectors

These connectors are the same as those for PL CH-A.

④ Program Input Connector

This female 3-pin XLR connector accepts a line-level audio signal from an outside source such as a mixing console or audio player. It is transformer-isolated. Level adjustment is done via the front-panel display programming. The program input can be assigned as an IFB source from the front panel.

⑤ Stage Announce Output Connector

This male 3-pin XLR connector allows a line-level audio signal, typically from wireless beltacks or 4-Wire sources, to be sent to a paging system or other audio system. It is transformer-isolated. Level adjustment is done via the front-panel display programming. More than one audio source at a time can be routed to the Stage Announce, with the audio being combined to give a single audio output.

⑥ Stage Announce Relay

This DB-9 male connector provides a relay closure that is triggered simultaneously with the SA Output. The relay may be used to open an audio pathway for the signal from the SA Output, or could also be used to activate a light or lock or some other device. The relay may be wired for normally closed or normally open operation, and the signal appears on pins 1 & 6 or 2 & 6. It is rated to a maximum of 30-VDC at 1 amp.

⑦ 4-Wire Matrix Ports

These four RJ-45 connectors can connect four full-duplex (input pair and output pair) audio connections from a 4-wire communications device, digital matrix intercom, or similar – making them available to the wireless beltacks. Any of the 4-wire ports or the program input can be assigned as IFB sources from the front panel.

Each of these connectors has its own time slot, and can be addressed separately from a beltack, or combined with other beltacks and rear-panel connectors in a group. Level adjustment is done via the front-panel display programming.

⑧ Base Loop Connector (not used)

The connector has no function in FreeSpeak V2.0.

⑨ LAN Connector

This RJ-45 connector allows the basestation to be connected to a LAN for system software upgrades and configuration downloads from the Configuration Editor. It is a 10BaseT Ethernet port.

⑩ PC Connector

This female DB-9 connects to a PC computer for firmware updates and monitoring of the system configuration. It functions as a serial port.

⑪ Transceiver Connectors

These two RJ-45 connectors connect the basestation to two remote FS-TA transceiver/antennas or antenna splitters.

Each wired transceiver/antenna communicates with five wireless beltacks. Each antenna splitter provides connection for five transceiver antennas, providing communication with up to a maximum of 10 beltacks depending upon available bandwidth.

Note: To meet FCC emissions requirements a ferrite must be fitted on any CAT-5 cable plugged into either of the two

ports labeled “tranceivers.” The ferrite should be fitted at the basestation end of the CAT-5 cable. Position the ferrite as close to the basestation as possible. A suitable ferrite is available from Wurth Elektronik. The part number is 742 711 32.

Note: It is recommended that shielded CAT-5 cable is used for FreeSpeak systems.

CONNECTING TO PARTY-LINE INTERCOM SYSTEMS

Up to two channels of party-line intercom can be connected to the FreeSpeak basestation. The descriptions below will discuss connections with Clear-Com and compatible party-line, RTS party-line, the ability of FreeSpeak to power up to four Clear-Com beltacks by itself, and the front-panel settings associated with these party-line connections.

Using the front-panel display and rotary encoder, the user may go into the PORTS menu, select the desired party-line channel, and create a five-character alphanumeric label for it. This is the label that would then appear on any FreeSpeak wireless beltacks to which that party-line connection was assigned for communications. In the GROUPS menu, the party-line connection can be assigned as a member of any of the groups, as desired.

CLEAR-COM AND COMPATIBLE PARTY-LINE

Clear-Com and Clear-Com-compatible wired party-line intercoms connect to the PL CH-A and PL CH-B connectors in a similar manner to connecting beltacks or remote stations to the intercom line. Typically that wired intercom connection would have a 30-VDC current on Pin 2, coming from a main station or an intercom power supply. The second connector in the pair may be used as a loop-through to go to other wired party-line stations or beltacks, or to a second FreeSpeak basestation. The pinout for party line connector is shown in table Table 4-1.

PIN	DESCRIPTION
1	Ground (shield)
2	Power
3	Audio

Table 4-1: Party Line Pinout

To connect party-line equipment to the basestation

1. Check that the party-line LED on the front-panel is out, which indicates that the party-line connection is disabled from the basestation.
2. Connect, and if appropriate, power up, the external party-line equipment.
3. Enable the party line by pressing the “enable” button on the basestation’s front panel.

The basestation detects power and termination settings when the party line is enabled by pressing the “enable” button on the basestation’s front panel, or when the basestation is powered up after having enabled the party line. The basestation remembers that the party line is enabled when it powers up.

When the FreeSpeak basestation detects a wired party line being connected with 30 VDC on Pin 2, it does not enable the 24-VDC power supply that the FreeSpeak basestation supplies to the connector to support a handful of locally connected wired party-line belt packs. The basestation then appears to the wired party-line system as a remote station.

The first call to a Party Line channel A or B results in the call alert and subsequent ones do not give any further alerting unless the Party Line channel buttons on the basestation are toggled. This prevents all calls giving alerts when this is not necessary.

CONNECTING DIRECTLY TO CLEAR-COM PARTY-LINE BELTPACKS

PL CH-A and PL CH-B have the ability to directly support up to four Clear-Com RS-501 or RS-601 party-line belt packs each, without any other connection to a wired party-line system. This feature gives the convenience of being able to add a few wired belt packs when needed to a FreeSpeak installation.

Connect a standard two-conductor shielded microphone cable to the PL CH-A connector, and then connect it to a Clear-Com single-channel party-line belt pack. The basestation will detect that the belt pack has been connected, and will enable the required 200-ohm termination, and will supply 24-VDC to Pin 2 to power the belt pack(s).

It is possible to daisy-chain up to four belt packs, or use an intercom XLR splitter at the basestation to feed mic cables connected to the individual belt packs. Because it is a 24-volt rather than a 30-volt current, the maximum length of cable that can be connected (the sum of all of the runs) will be shorter than what is expected with the standard party-line voltage. Do the same with PL CH-B to support an additional four belt packs.

To connect to the party line

1. From the main menu, scroll to PORTS and select by pressing the setup/enter knob in.
2. Scroll to PLCHA or PLCHB and press to select.

- The SELECTED PORT screen appears.
3. Scroll to and select CALLS.
The CALL DESTINATION screen appears.
 4. Select the port or group to be connected to the party line by scrolling to it and pressing the rotary encoder. Doing so creates a route to the selected destination—this port or group can now hear the activity on the party line. (Note: this option can also be set to NONE.)
 5. Select TYPE from the menu.
 6. Select either Clear-Com, Drake, or RTS.
The basestation automatically sets the termination, audio levels, and call signaling options for the selected party-line system.
Note that the Basestation does not detect the RTS call signal.
 7. If the changes are saved the route will be reinstated on power up.

Note: Suggested settings for a party line connection are that the VOX should be set to -26dB, the gain output to -6dB and the input to 0dB.

CONNECTING TO AN RTS™ WIRED BELTPACK

FreeSpeak can only transmit and receive audio from channel 2 of an RTS wired beltpack. Connect using a standard XLR cable. Ensure that the party-line type is set to “RTS” using the menu on the basestation before enabling the party line. See the chapter “Programming a System from the Basestation” for more information.

Warning: Previous versions of this manual described a cable which would allow access to channel 1 of a dual channel RTS beltpack. DO NOT attempt to use a cable like this as it could result in damage to the FreeSpeak basestation.

FRONT-PANEL ADJUSTMENTS FOR PARTY-LINE CONNECTIONS

To connect the party-line channels to FreeSpeak and make the communication available to the rest of the system, press the CH-A and/or CH-B enable switches. The LED will light, and the connection is made. To disconnect the party-line connections, press these switches again. The switch may be “locked” in the SYSTEM menu so that the party lines may not be disconnected.

Because party-line intercom does not have global level control on a channel, input and output level controls are provided via the front panel programming. Scroll to PORTS on the main display screen and press the rotary encoder to select. Scroll to PLCHA or PLCHB and press to select. Select LEVELS, then select the input or output level. This notation is relative to the basestation—input level refers to the level at which everyone else hears the party line, and output level refers to the level at which the users on the party line channel hear everyone else.

Use the rotary encoder to adjust the numerical level—clockwise to increase the level and counter-clockwise to decrease the level.

Make the estimated changes in level and press the rotary encoder to save the changes. Test the levels between the party line and FreeSpeak beltpack, and make additional changes as needed. When the levels are set as desired, press to select and the display will go to the previous INPUT/OUTPUT screen. When both are adjusted, select BACK on each screen until the main screen is displayed.

Users connected to the basestation can be forced to listen to the activity on the party line by initiating a “call”.

For more information on programming the basestation, see the chapter “Programming a System from the Basestation”.

TROUBLESHOOTING PARTY-LINE CONNECTIONS

Reducing FreeSpeak Beltpack echo when talking to a analogue party-line

If the basestation and beltpack are not set up correctly the FreeSpeak user will experience an echo when talking to a party-line (either directly or via a group or a wireless party-line). The echo is caused by either local audio coupling in the headset due to the microphone gain being set too high or audio reflections from the party-line that can be minimized by setting a VOX gate on the party-line and the party-line being auto nulled.

How to set the microphone gain in the beltpack

When using a CC-260 or CC-95 the microphone gain should be set at 55dB (55dB is the default setting).

Note: If the microphone gain is set higher than 55dB this can introduce audio coupling between the ear phone and the microphone.

Include the Party-Line channel inside a Wireless Party-Line group

It is recommended that when connecting to an analogue party-line system that the user includes the wireless party-lines (WPL). The WPLs reduce the variation in audio levels heard when talking to analogue party-lines. The WPLs are created in the configuration editor in a similar way to a user creating a group.

How to set the VOX gating level on the Party-Line connected to the Basestation

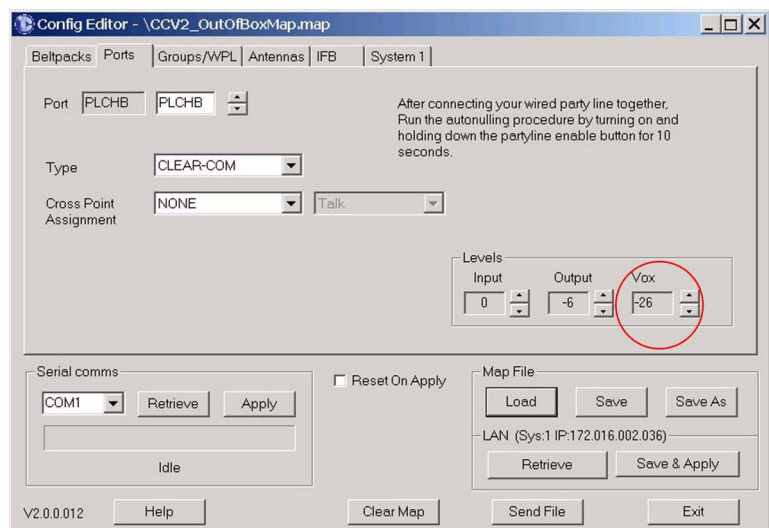

Figure 4-2: VOX Gating Level on Party Line Connection

The VOX gate allows the user to set limits to the audio that will be passed from the party-line to the basestation mixer; by setting the VOX level at the correct level the user can cut the audio reflections (which cause the echo) from the party-line when a wireless beltpack user speaks. This is achieved when the VOX level is set above the audio level of the reflections, thus allowing a party-line user's voice to pass through the VOX gate in the basestation mixer but the VOX gate will reject the audio reflections.

Note: If both the party-line user and the FreeSpeak user speak at the same time, the FreeSpeak user may hear the echo as the audio reflections piggy back the party-line audio.

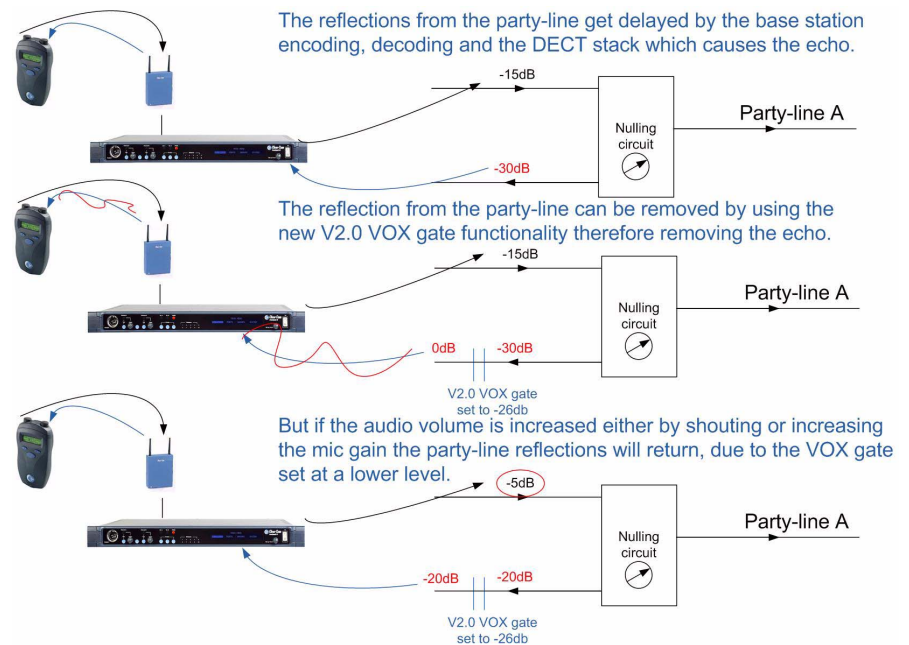

Figure 4-3: VOX Gate Setting Examples

Note: If the FreeSpeak beltpack users shouts or increases the microphone gain into the beltpack the echo might return if the audio reflects are above the VOX gate level.

Auto null the Party-Line channel at the Basestation

Party-lines connected to the base station can be auto nulled by first enabling party-line channel by pressing the party-line button on the front of the basestation.

The auto nulling is then activated by pressing and holding the enable party-line button; the base station will go then into a auto null routine.

WIRELESS PARTY LINE

The FreeSpeak basestation provides five wireless party line groups which allow up to twenty eight members to be connected together in a conference call. The beltpack keys assigned to the wireless party line group are assigned as dual talk and listen and party lines connected to the group are assigned as talk and listen.

When a beltpack or party line talks to a wireless party line group the talk signal from the beltpack or party line is subtracted from the listen signal to remove the sidetone resulting from the users voice being looped back in the conference audio, leaving only the audio from other members.

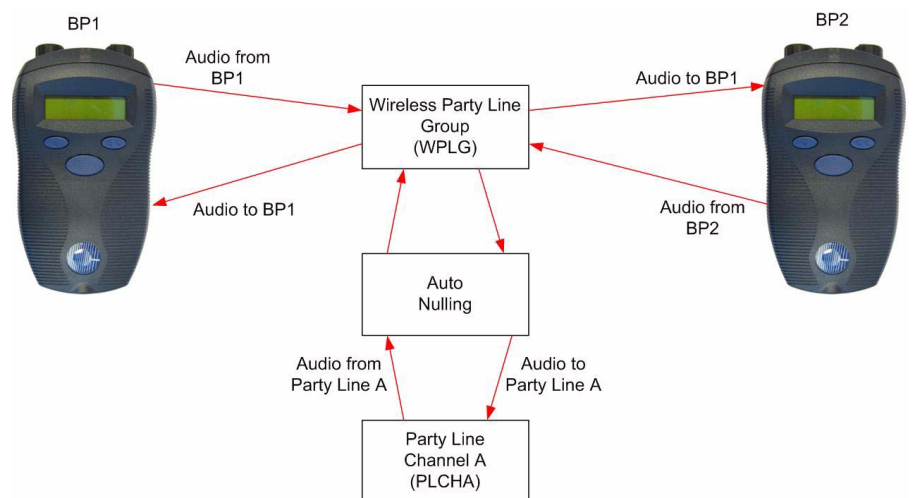

Figure 4-4: Wireless Party Line Audio Flow

This facility allows conferencing over a large area between a mix of beltpacks, party line stations and Eclipse system panels through a FreeSpeak basestation.

CONNECTING TO 4-WIRE AND DIGITAL MATRIX INTERCOM

Up to four channels of 4-wire/digital matrix intercom can be connected to the FreeSpeak basestation. The descriptions below will discuss connections with Clear-Com Matrix Plus digital matrix, Clear-Com Eclipse digital matrix, other brands of digital matrix intercoms, other 4-wire audio devices, and the front-panel settings associated with these 4-wire connections.

To connect the basestation to a matrix port:

1. Scroll to PORTS on the main display screen and press the rotary encoder to select.
2. Scroll to 4-WIRE and press to select.

3. Scroll to CALLS and press to select.
4. Select the port or group to create an audio path to and press to select. Doing so creates a route to the selected destination—this port or group can now hear the activity on the party line. (Note: this option can also be set to NONE.)
5. Once the changes have been saved, the route will be reinstated on power up.

Note: Call signalling is not currently supported on 4-wire connections.

In the GROUPS menu, the 4-wire port can be assigned as a member of any of the groups, as desired.

4-Wire Pinout

The pinout for the RJ-45 4-wire port is shown in Table 4-2.

RJ-45 CONNECTOR AT BASE STATION PORT

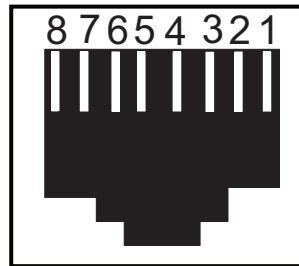

Figure 4-5: Front View of RJ-45 Connector

Pin	Description
1	Not used
2	Not used
3	Audio Output +
4	Audio Input +
5	Audio Input -
6	Audio Output -
7	Not used
8	Not used

Table 4-2: FreeSpeak Basestation 4-Wire Pinout

CONNECTING WITH CLEAR-COM MATRIX PLUS

The connection between a Matrix Plus digital intercom port and a FreeSpeak 4-wire port is accomplished with a standard 4-pair straight-through CAT-5 data cable with RJ-45 connectors on both ends. In the current generation of FreeSpeak, the audio input and audio output pairs are all that will be used.

In the Matrix Plus PGM-WIN configuration software, set the matrix port that is connected to the FS-BASE basestation 4-wire port to “4-Wire”. If the label of this FreeSpeak 4-wire port is to be put onto more than one intercom panel within the matrix system, and any and all people who have activated a talk/listen to that port to be able to hear each other, as well as hearing the person talking to them from the FreeSpeak wireless beltpack, also check “Party-Line Enable” for that 4-Wire connection in the configuration software.

Within the FreeSpeak Basestation configuration software, the user can adjust the input and output level for that port. Alternately, the input and output levels can be adjusted on the FreeSpeak basestation for the particular 4-wire port, using the front-panel display. Repeat the procedure for each FreeSpeak 4-wire port that is connected with the Matrix Plus system. Note that FreeSpeak does not currently generate a call signal to the Matrix port.

CONNECTING WITH CLEAR-COM ECLIPSE DIGITAL MATRIX

The procedure to connect between a FreeSpeak 4-wire port and the Eclipse digital matrix is similar to that of Matrix Plus 3. An identical connection is made with 4-pair straight-through CAT-5 cable between an Eclipse port and the FreeSpeak port.

Within the Eclipse Configuration System software (ECS), set the port to “Direct.” This will allow intercom stations in the Eclipse system to converse with the FreeSpeak basestation and beltpacks. Because

there is not a “Party-Line Enable” within Eclipse, if several users of intercom stations connected with Eclipse need to hear each other as well as the wireless FreeSpeak beltpack, another procedure will need to be added. Within the configuration software, the user would create a new party-line label, with members including the desired intercom stations and the particular FreeSpeak 4-wire port. That label would then be assigned to a key on each of the intercom stations, allowing connection with the FreeSpeak 4-wire port and the other members of the new party-line.

Within the FreeSpeak Basestation configuration software, the user can adjust the input and output level for that port. Alternately, the input and output levels can be adjusted on the FreeSpeak basestation for the particular 4-wire port, using the front-panel display. Repeat the procedure for each FreeSpeak 4-wire port that is connected with the Eclipse system.

CONNECTING WITH OTHER DIGITAL MATRIX INTER-COM SYSTEMS

Because FreeSpeak features standard 4-wire ports, with an input pair and an output pair, virtually any 4-wire signal can be connected with it. Make sure to properly match the input and output pairs between the digital matrix port and the FreeSpeak 4-wire port (see diagram below).

The pinouts for the first two 4-wire ports contain both audio and data connections, though the data connections are not currently used. Those pinouts are shown in the following table.

PIN	FUNCTION
1	Data Tx+
2	Data Tx-
3	Audio Out+
4	Audio In+
5	Audio In-
6	Audio Out-
7	Data Rx+
8	Data Rx-

Table 4-3: Pinouts for Connecting to Other Digital Matrix Intercom Systems

The remaining two 4-wire connections are audio only, and the data connections are unterminated (see Table 4-2).

Within the configuration software of the other digital intercom system, configure its connected port to 4-wire or similar. Adjust the input and output levels either at matrix side or within the FreeSpeak front-panel display for the particular FreeSpeak 4-wire port.

CONNECTING WITH OTHER 4-WIRE DEVICES

Various other 4-wire audio devices can be connected with FreeSpeak. The Clear-Com EF-701M 4-wire interface can be used to attach additional party-line channels to FreeSpeak, converting them from party-line on the wired side to 4-wire on the FreeSpeak side.

The Clear-Com IF4W4 interface can be used similarly. The audio input side of the FreeSpeak 4-wire connectors could be used for additional program or other audio inputs that could then be accessed by FreeSpeak beltpacks. The audio output side of the FreeSpeak 4-wire connectors could be used to route a FreeSpeak wireless beltpack user's voice out of the system for paging or other reasons, similar to the SA OUT connector.

When using the FreeSpeak 4-wire ports in this way, make sure that proper connections are made between FreeSpeak and the other device. Adjust the input and/or output levels either at the 4-wire device or within the FreeSpeak front-panel display for that particular 4-wire port.

CONNECTING TO A PROGRAM AUDIO SOURCE

FreeSpeak can connect with a program audio source, making it accessible to be assigned by itself to a communication path to one or more FS-BP wireless beltpacks, or to be added to a group with other communications and assigned to beltpacks. Using the two separate rotary encoder volume controls on the beltpack, the user can monitor the program on one control while talking and listening on an intercom channel with the other.

The balanced female 3-pin XLR connector accepts a standard audio signal from a mixing console or similar, with Pin 1 ground, Pin 2 audio hot (+), and Pin 3 audio cold (-). This connector is transformer-isolated.

To make the program input signal available to the system, the front-panel PRGM enable button must be activated/on. The red LED above it will light, indicating that it is now available. This front-panel switch may be "locked" to prevent accidental disengagement, using the front panel display.

Using the front-panel display and rotary encoder, the user may select PORTS and give the connector a five-character alphanumeric label. The user may assign that program input by itself to a beltpack using the BELTPACKS menu, or use the GROUPS menu to assign the program input to any group or wireless party line. Program input can be assigned to multiple groups or wireless party lines using the GROUPS menu.

IFB CONFIGURATION

One of five FreeSpeak basestation inputs can be defined as a source for an IFB. These inputs are the Program Input and the four 4-Wire ports. All the 4-Wire ports, party line channels, beltpacks, wireless party lines and stage output can be defined as IFB destinations.

Up to ten IFB key configurations can be set up that group together an IFB source and a number of IFB destinations and set the dimming level for that IFB key configuration.

IFB Source	IFB Destination	IFB Talks
Program Audio	Four-wire 3 Four-wire 4 All beltpacks	All beltpacks
Four-wire 3	Four-wire 4 All beltpacks	All beltpacks
Four-wire 4	Four-wire 3 All Beltpacks	All beltpacks

Table 4-4: IFB Key Configurations

An IFB talk is a panel or beltpack with a key set up to talk to the IFB key configuration. Whenever an IFB talk key is pressed the audio from the IFB source to the IFB destinations configured in the IFB key configuration is dimmed by the set amount and the audio from the IFB talk is heard by all the IFB destinations set up in that IFB key configuration.

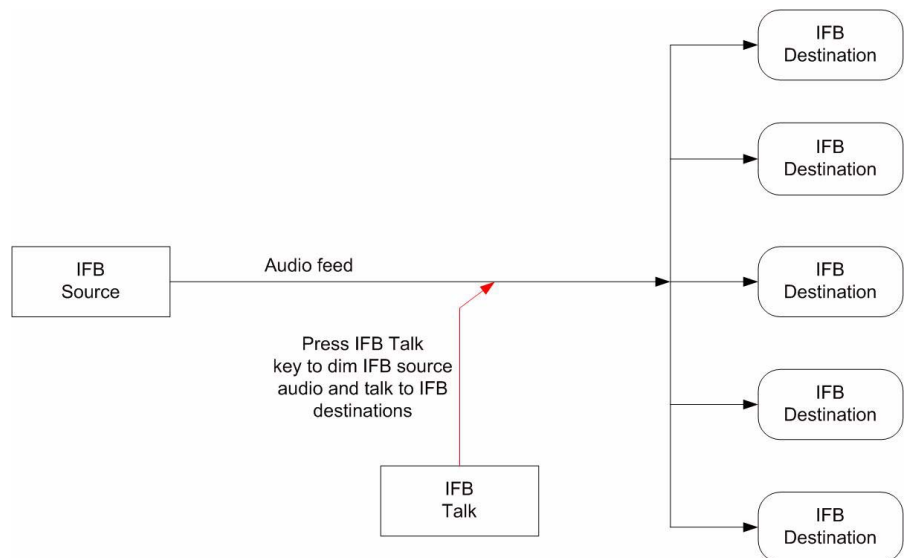

Figure 4-6: IFB Audio Path

The IFB source audio will be dimmed on the IFB destinations for as long as the IFB talk key is active. When the IFB talk key is released the IFB source audio to the destinations will return to normal level.

CONNECTING TO THE STAGE ANNOUNCE OUTPUT

The stage announce feature allows a talker to route their voice to an external paging system or other audio destination by pressing one of the rotary encoders to which the SA OUT connector is assigned. The adjacent SA RELAY is simultaneously triggered. One beltpack user at a time may use this feature, though the capability may be assigned to any or all of the wireless beltpacks, as desired.

Connect a microphone cable to the male 3-pin XLR connector on the rear of the FreeSpeak basestation, and connect the other end to the external audio system. When the output is activated, the beltpack user's voice will be sent at line level to the audio system. The audio output ceases when the beltpack user stops pressing the rotary encoder; it is good practice to make sure that any rotary encoder to which the SA OUT is assigned is set to momentary/non-latching mode.

PIN	FUNCTION
1	Normally Closed
2	Normally Open
3	N/C (no connection)
4	N/C
5	N/C
6	Pole
7	N/C
8	N/C
9	N/C

Table 4-5: Pin Assignments for Stage Announce Connector

The associated SA RELAY can be assigned to open an audio route for the paging or announcement, or can be assigned to initiate any other event such as turning on a light or activating a lock. It is rated at a maximum of 30 VDC at 1 ampere. The relay can be wired to be either normally open or normally closed, using the pinout information in Table 4-5.

CONNECTING TO A PC

CONNECTING VIA THE SERIAL PORT

The PC serial port on the rear of the FreeSpeak basestation is mainly used for firmware version upgrades of the system.

A specially wired cable is required for these updates, consisting of two 9-pin D-type connectors for the PC and the FreeSpeak ends. On the FreeSpeak end, a male 9-pin D connector is used, and is wired as follows in relation to the D connector pins on the PC end. Pin 2 goes to pin 3, pin 3 goes to pin 2, and pin 5 goes to pin 5; in other words, the data Tx and Rx lines on pins 2 and 3 are reversed. Those are the only wiring connections on the FreeSpeak end of the cable.

PC CONNECTION (9-PIN F)	BASESTATION (9-PIN M)
1	N/C
2	3
3	2
4	N/C
5	5
6	N/C
7	N/C
8	N/C
9	N/C

Table 4-6: Pinout for Cable to Upgrade Basestation Firmware

On the PC end, a female 9-pin D connector is used. Make sure that the data connections of pin 2 to pin 3 and pin 3 to pin 2 are followed, and that pin 5 goes through to pin 5. Then short pins 1, 4, 6, and 8 together on the PC end of the cable. The cable will now be ready to use with the any upgrade files from the factory. Table 4-6 gives the pin configuration for this cable. Table 4-7 shows the pin configuration for the cable used to upgrade beltpack firmware.

PC CONNECTION (9-PIN F)	BELTPACK (3.5 mm jack)
1	N/C
2	tip
3	ring
4	N/C
5	screen
6	N/C
7	N/C
8	N/C
9	N/C

Table 4-7: Pinout for Cable to Upgrade Beltpack Firmware

CONNECTING VIA THE LAN PORT

This connection is used for rapid firmware updates, as well as in the future for system configuration and intelligent connection with the Eclipse digital matrix. It is wired as a standard Ethernet connection.

The basestation has a fixed IP address. This can be found by selecting SYSTEM and then INFO from the front-panel display menu. Refer to the chapter “FreeSpeak Toolkit” for more information on using the LAN port to upgrade firmware.

CONNECTING TO TRANSCEIVER/ANTENNAS (FS-TA)

CONNECTING ONE TRANSCEIVER/ANTENNA (FS-TA) DIRECTLY TO A TRANSCEIVER PORT

A FS-TA transceiver/antenna connects to the transceiver port on the FreeSpeak basestation using a standard 4-pair CAT-5 data cable with RJ-45 connectors. It may be located up to 1,000 meters from the basestation if 24AWG cable is used for 500 meters if 26AWG cable is used creating a coverage area for five FS-BP wireless beltpacks in that location. The port is able to provide the required power to the transceiver/antenna at a distance of up to 300 meters (approximately 900 feet); beyond that distance, the FS-TA transceiver/antenna must be locally powered via its in-line external universal power supply.

Note: It is recommended that shielded CAT-5 cable is used.

To know that a FS-TA transceiver/antenna is active, observe the green power LED and the yellow signal LED on the face of the unit where the RJ-45 connector is connected. Both must be lit. Also, wireless beltpacks in the vicinity of the active transceiver/antenna will be

connected to the system and their displays will show labels and other information.

Using both transceiver ports, a basestation may be connected with up to two transceiver/antennas via a direct connection with the basestation. For the best, most reliable coverage, it is advisable to use a minimum of two transceiver/antennas in any installation, positioned in different locations in the coverage area. When more FS-TA's are required to support a larger coverage area or more wireless beltpacks, an antenna splitter will need to be introduced between the basestation and the transceiver/antennas.

Note: In some situations, particularly in outdoor venues, interference from non-DECT sources can severely reduce the range of the system. In these cases we recommend a site survey as described in Chapter 8, "Installing a System".

CONNECTING TRANSCEIVER/ANTENNAS WITH A SPLITTER (PD2203)

A splitter (PD2203) will connect up to five transceiver/antennas to one of the transceiver ports on the FreeSpeak basestation, creating up to five coverage zones that can be overlapped to make large areas where FS-BP wireless beltpacks can have continuous coverage. The use of the splitter also extends the distance that the FS-TA transceiver antennas can be located from the basestation to 2,000 metres (6,400 feet) if 24AWG cable is used or 1,000 metres (3,200 feet) if 26AWG cable is used (assuming the same type of cable to be used to connect the antenna to the splitter and the splitter to the basestation).

Note: It is recommended that shielded CAT-5 cable is used.

For example, a splitter can be used to connect to a FreeSpeak basestation that is located in a production truck outside an arena or stadium, with a single CAT-5 cable going to the splitter which is then located just inside the stadium. From that splitter, up to five FS-TA transceiver/antennas are distributed throughout the stadium to create wide coverage – each with a run of CAT-5 cable back to the splitter. A similar arrangement may be used in a large theatre or performing arts facility.

The connection between a transceiver port on the FreeSpeak basestation and a PD2203 splitter is accomplished with standard 4-pair CAT-5 data cable with RJ-45 connectors. It is connected to the port labeled MATRIX on the splitter. This cable can be as long as 1,000 metres (3,200 feet) if 24AWG cable is used or 500 metres (1,600 feet) if 26AWG cable is used. The splitter must be locally powered via its DC IN connector, using the in-line external universal power supply. The RJ-45 ports on the splitter labeled "1" through "5" are the connections to the FS-TA transceiver/antennas. Transceiver/antennas connected to the splitter can be powered at a distance of up to 300

metres (900 feet); beyond that distance they will need to be locally powered.

Note: To use the system with cable lengths over 200m the software update in release 1.5.6 or better must be installed on the basestations.

POWERING AN ANTENNA OR ANTENNA SPLITTER

Provision of 24 VDC power to a FreeSpeak antenna is done in one of three ways:

- Connect the antenna to a 150/UNI-DIN power supply unit through the 4-pin DIN connector at the antenna.
- Connect the antenna to an antenna splitter which is powered by a power-supply unit.
- Connect the antenna to a FreeSpeak basestation's "transceiver" RJ-45 connector.

The preferred method is to connect the antenna to a powered antenna splitter, as illustrated in Figure 4-7. An antenna splitter distributes power to all antennas connected to it. A single power-supply unit can power the maximum 10 antennas. However, cable lengths will be reduced.

POWERED BY BASE STATION ONLY

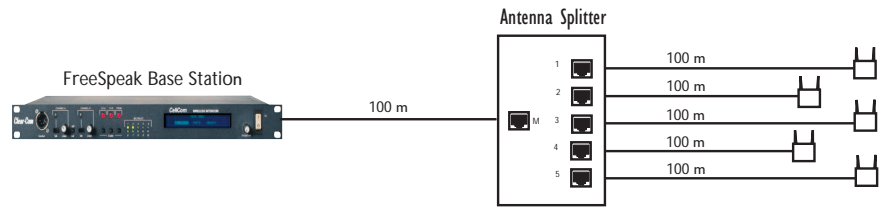

PSU AT THE ANTENNA SPLITTER ONLY

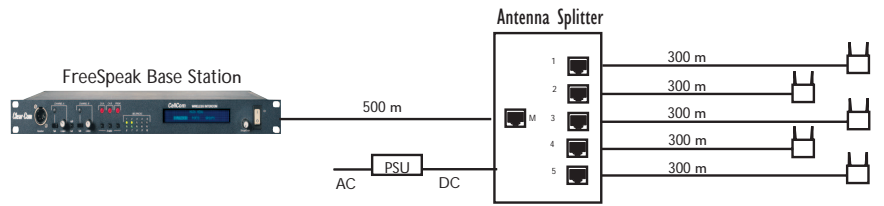

PSU AT THE SPLITTER AND ACTIVE ANTENNA

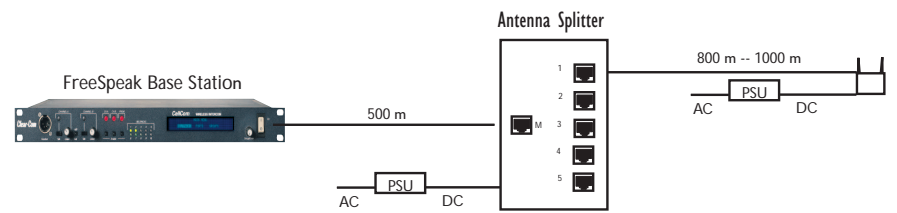

Figure 4-7: Powering an Antenna Splitter

5

PROGRAMMING A SYSTEM FROM THE BASESTATION

A system is programmed using the menus displayed on the basestation's front panel.

Scroll to an item by turning the setup/enter knob. Select an item by pressing the knob in, as if it were a pushbutton.

A FreeSpeak system is programmed using the menus displayed on the basestation's front panel. Programming the system requires four basic steps:

- 1. Create individual names ("labels") for the wireless beltacks and for the wired devices connected to the basestation.** Use individual labels for building "point-to-point" communication paths. Labels are composed of five alphanumeric characters. Labels can be created for users' names ("John" or "Susan"), roles ("AUDIO" or "DIR"), or for connections ("PL_A" or "PL_B"). Alternatively a device's generic name can be used, which never changes. An example of a generic name is "BPK01" for Beltpack 1. Generic names are always displayed on the programming menus.
- 2. Create names ("labels") for groups.** A group label is used when a FreeSpeak beltack needs to communicate with all members of a group simultaneously, as in a party line. Up to ten groups can be created, with five groups being standard groups and five groups being wireless party line groups. Up to fifteen members can be assigned to a standard group and up to twenty eight members can be assigned to a wireless party line group.
A label can be customized to reflect the group's function, such as "STG-A" for communicating with the production staff on Stage A. Alternatively the generic names assigned for the ten possible groups can be used. For example, "GP#01" is the generic name for Group 1.
- 3. Assign members to the groups created.** Group members are drawn from the wireless beltacks and from the wired devices connected to the basestation. A group created from these devices functions as a party line, in which all members of the group can communicate simultaneously with all other members of the group.
- 4. Assign individual and grouped devices to each FreeSpeak beltack by using the programming screens on the basestation's front panel.** Each assignment creates a communication route from the FreeSpeak beltack to the selected device or group. Up to six communication routes can be assigned to a beltack.

These steps are discussed in more detail in the following sections.

“Source” refers to a device—beltpack, intercom station, or a variety of other devices—from which audio is received.

“Destination” refers to a device to which audio is sent.

There are two ways to save changes.

A NOTE ABOUT TERMINOLOGY

In this manual, the term “source” refers to a device—beltpack, intercom station, or a variety of other devices—that sends audio to a beltpack. It represents a “listen” path to a station. The term “destination” refers to a device to which audio is sent. It represents a “talk” path from a beltpack.

The names of these sources and destinations appear in the display of a beltpack and are called “labels”. A label is a 5-character alphanumeric name that identifies a source, destination, or control function accessed by a beltpack. These “labels” are programmed from the FreeSpeak basestation.

USING THE BASESTATION’S PROGRAMMING MENUS

A FreeSpeak system is programmed using the programming menus that appear on the basestation’s front-panel display screen. The user navigates through the menus to select programming options for the system.

Rotating the setup/enter knob allows the user to scroll through the selections on the screen. As the user scrolls through the menu items are highlighted on the screen. To select an item as a new programming option, press the setup/enter knob in, as if it were a pushbutton, when the desired item is highlighted on the screen.

SAVING CHANGES

The changes are saved and applied automatically when changes are made to the unit’s programming. Five seconds after the last time the setup/enter knob was turned or pressed, the front-panel display flashes to indicate that the changes are being saved and applied.

BASESTATION PASSWORD

With the FreeSpeak V2.0 release the basestation requires a password to be input before it will operate once the firmware is upgraded. The password requires the basestation system ID which is found in the system information screen (see “System INFO (“INFO”)” on page 5-27).

The basestation password will normally be supplied with the V2.0 CD but if it is not available the user should contact Clear-Com for a password.

After the basestation is upgraded it will display the following message when the first map is downloaded.



Figure 5-1: Initial Password Request Display

To enter the password press the Setup/Enter knob to display the main menu and select 'SYSTEM'. Scroll through the system menus until the 'PASSWORD' menu is displayed.

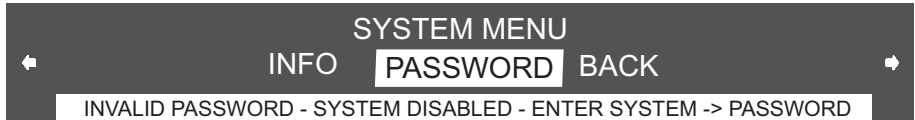

Figure 5-2: System Password Menu

Scroll to the 'PASSWORD' entry and select it. The password entry screen will be displayed.

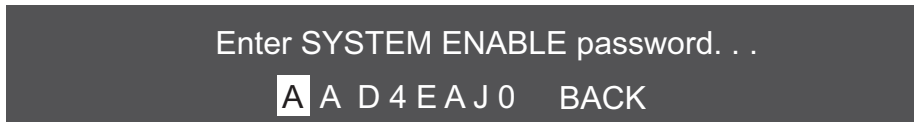

Figure 5-3: System Password Entry

The first character is a string of eight characters will be highlighted ready for the system password to be entered.

1. Scroll to and select the alphanumeric character to be changed. A box appears around the character.
2. Rotate the setup/enter knob. As the knob is rotated the entire range of available characters appears, starting with upper-case characters, proceeding to lower-case characters, then to digits, and finally to punctuation characters.
3. When the desired new character appears, press the setup/enter knob to select it. The box disappears, and is replaced by the solid highlight.
4. Repeat steps 1 through 3 to enter all the characters in the system password.
5. When editing the label has been completed press the Setup/Enter knob. The system should display the message "PASSWORD ACCEPTED - MATRIX RESETTING".
6. The matrix will reset and begin normal operation. If the password is incorrectly entered the system will reject it.

Once the system password has been entered the 'PASSWORD' entry will no longer be displayed on the system menu.

CHANGING BELTPACK LABELS

Use individual labels for point-to-point communication routes.

The first step in creating a FreeSpeak system is to create individual names (“labels”) for the wireless beltpacks and for the wired devices connected to the basestation. Use individual labels for building “point-to-point” communication routes.

To change a beltpack label

1. From the MAIN menu on the basestation’s front panel display, scroll to and select BELTPACKS, as shown in Figure 5-4.



Figure 5-4: From the MAIN menu, select BELTPACKS

The AVAILABLE BELTPACKS menu appears, as shown in Figure 5-5. The first page shows the first five beltpack labels.

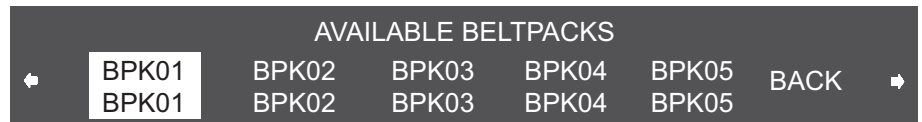

Figure 5-5: Available Beltpacks Menu

- The beltpacks’ generic labels BPK01 through BPK05 appear on the upper row, while the labels given to the beltpacks appear just under the generic labels. At first both upper and lower labels will have the same generic designations.
 - To get to the second, third and fourth pages, scroll all the way to the right of the screen, and then continue to scroll. The second, third and fourth pages will be displayed showing beltpacks 6 - 10, 11 - 15 and 16 - 20 (BPK06 - BPK10, BPK11 - BPK15, BPK16 - BPK20).
2. Scroll to and select the desired beltpack label.
The next menu that appears gives the options for programming the selected beltpack, as shown in Figure 5-6.

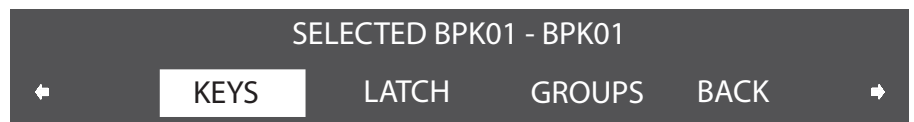

Figure 5-6: First Beltpack Programming Options Menu

3. Scroll all the way to the right of the screen and continue to scroll. The second beltpack programming options menu will be displayed.

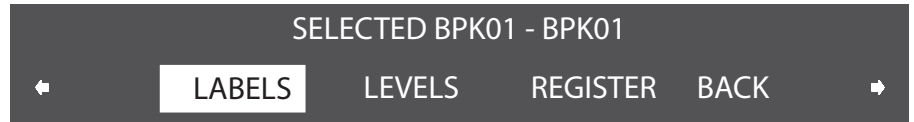

Figure 5-7: Second Beltpack Programming Menu

4. Scroll to and select LABEL from the menu.
A menu to edit the selected beltpack's label appears, as shown in Figure 5-8. The current 5-character label appears, just under its generic name.

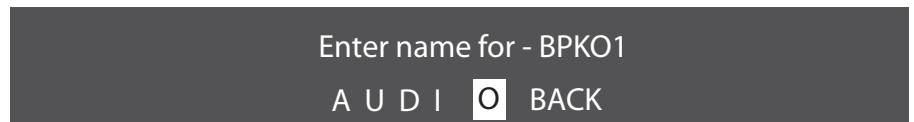

Figure 5-8: Editing a Beltpack's Label

5. Scroll to and select the alphanumeric character to be changed. A box appears around the character.
6. Rotate the setup/enter knob. As the knob is rotated the entire range of available characters appears, starting with upper-case characters, proceeding to lower-case characters, then to digits, and finally to punctuation characters.
7. When the desired new character appears, press the setup/enter knob to select it. The box disappears, and is replaced by the solid highlight.
8. Repeat steps 4 through 6 for all the characters in the label that are to be changed.
9. When editing the label has been completed, select and then de-select the fifth character to return to the PROGRAMMING OPTIONS menu.

Note: The user must select the fifth character, even if it is blank, as in a label with less than five characters.

10. The changes are saved and applied automatically five seconds after the last time the setup/enter knob was pressed or turned. The front-panel display flashes to indicate that the changes are being saved and applied.
11. The beltpack that has had a new label assigned to it should be power cycled to ensure it is updated with the new label.

To edit another beltpack label, scroll clockwise to the BACK command and select it. The AVAILABLE BELTPACKS screen appears. Select a new beltpack label to edit, and repeat steps 2 through 9.

SETTING AND CHANGING PORT LABELS

Port labels identify the devices wired to the basestation's rear panel ports.

Port labels are created to identify the audio devices wired to the basestation's rear panel ports, such as party-line beltpacks, 4-wire devices, program sources, and stage-announce outputs and relays.

To create a port label

1. From the basestation's MAIN menu, scroll to and select PORTS (see Figure 5-9).



Figure 5-9: Select "Ports" from the Main Menu

Audio ports include headset, 4-wire, party line, stage announce, and program source labels.

The first AVAILABLE AUDIO PORTS menu is displayed, as shown in Figure 5-10.

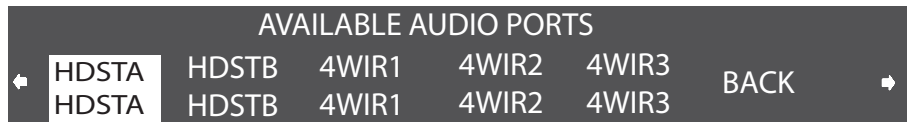

Figure 5-10: First Available Ports Menu

The first page of the menu shows the first 5 ports, starting with HDSTA (front-panel headset A) and continuing through 4WIR3 (the third 4-wire connector on the rear panel), as shown in Figure 5-10. By scrolling all the way to the right, and then continuing to scroll, 4WIR4 through PRGRM (program) will be displayed (Figure 5-11).

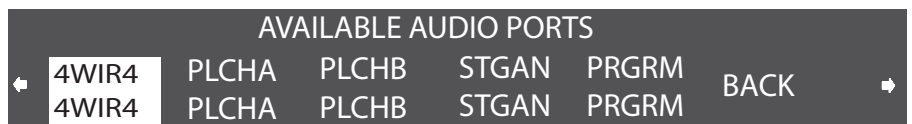

Figure 5-11: Second Available Ports Menu

Note: The upper character of the pair is a generic label, while the lower character is editable.

The upper label retains the same generic label, while the lower label can be edited to the user requirements.

2. Select an audio port from the menu. A screen appears that gives the options for programming the selected port, as shown in Figure 5-12.

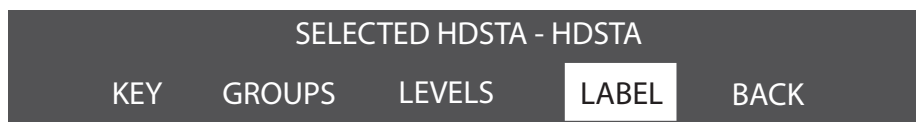

Figure 5-12: Port Programming Options Menu

3. Select LABEL from the menu.

A menu to edit that port's label appears as shown in Figure 5-13.

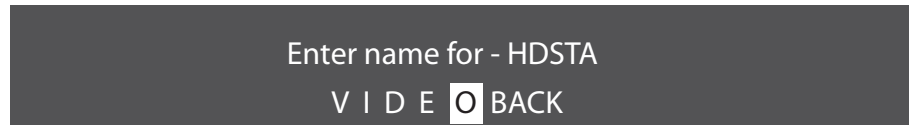

Figure 5-13: Editing a Port's Label

4. Scroll to and select the alphanumeric character to be changed. A box appears around the character.
5. Rotate the setup/enter knob. As the knob is rotated the entire range of available characters appears, starting with upper-case characters, proceeding to lower-case characters, then to digits, and finally to punctuation characters.
6. When the desired new character appears, press the setup/enter knob to select it. The box disappears, and is replaced by the solid highlight.
7. Repeat steps 4 through 6 for all the characters in the label that are to be changed.
8. Select 'BACK' to save the label. The front-panel display flashes to indicate that the changes are being saved and applied.

In order to edit another port label, scroll clockwise to the BACK command and select it. The AVAILABLE AUDIO PORTS menu appears. Select a new audio port to edit, and repeat steps 2 through 9.

SETTING AND CHANGING GROUP LABELS

A group label is used when a FreeSpeak beltpack needs to communicate with all members of a group simultaneously, as in a party line. The user can create up to ten groups. Five of these can be standard groups with up to fifteen members per group and five can be wireless party line groups with up to twenty eight members per group.

Group members can be individual beltpacks or wired devices connected to the basestation. To form a group, the user must first create a name or "label" for the group, and then assign members to the group.

To create a group label

1. From the main menu, select GROUPS. The first page of the AVAILABLE GROUPS menu appears, as shown in Figure 5-14. The 5 standard group labels appear on the first page of the menu. The generic labels GP#01 through GP#05 appear on the top row, and their editable versions appear on the lower row. The default values are GRP01 through GRP05.

First create a group label, and then add members to the group.

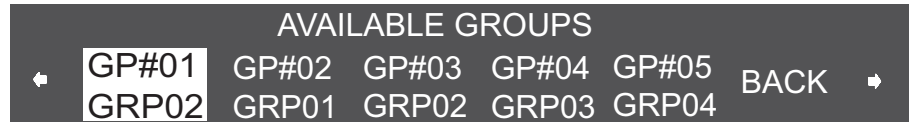

Figure 5-14: Standard Group Labels

By scrolling all the way to the right, and then continuing to scroll, the wireless party line groups appear on the second page of the menu.

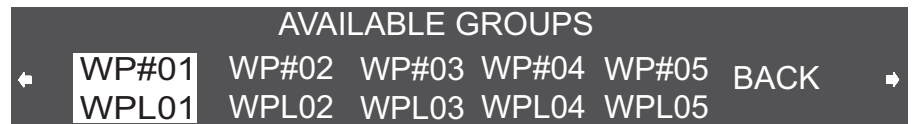

Figure 5-15: Wireless Party Line Group Labels

The generic wireless party line group labels WP#01 through WP#05 appear on the top row, and their editable versions appear on the lower row. The default values are WPL01 through WPL05.

- From the AVAILABLE GROUPS menu, select a group label. A menu appears that gives the options for programming the selected group, as in Figure 5-16.

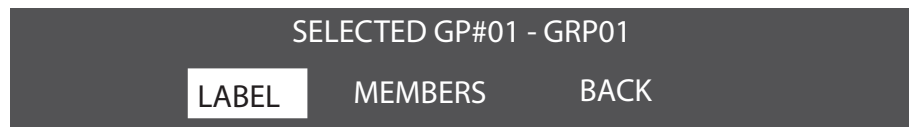

Figure 5-16: Select Label from the Menu

- Select LABEL from the menu. A menu to edit that group label appears, as shown in Figure 5-17.

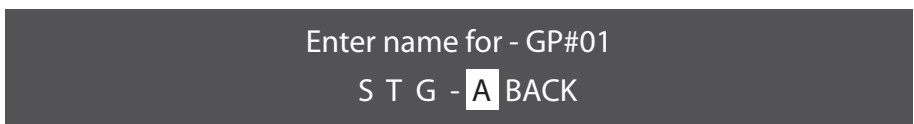

Figure 5-17: Group Name Edit Menu

- Scroll to and select the alphanumeric character to be changed. A box appears around the character.
- Rotate the setup/enter knob. As the knob is rotated the entire range of available characters appears, starting with upper-case characters, proceeding to lower-case characters, then to digits, and finally to punctuation characters.
- When the desired new character appears, press the setup/enter knob to select it. The box disappears, and is replaced by the solid highlight.
- Repeat steps 4 through 6 for all the characters in the label that are to be changed.

8. Select 'BACK' to save the label. The front-panel display flashes to indicate that the changes are being saved and applied.

In order to edit another group label scroll clockwise to the BACK command and select it. The AVAILABLE GROUPS menu appears. Select a new group label to edit, and repeat steps 2 through 9.

ADDING GROUP MEMBERS

When a group name or “label” has been chosen the user may then “populate” that group. Group members are drawn from the individual wireless beltacks and individual wired devices connected to the FreeSpeak basestation. A group created from these devices functions as a party line, in which all members of the group can communicate simultaneously with all other members of the group. A standard party line group may contain up to fifteen members and a wireless party line group may contain up to twenty eight members.

To assign members to a group

1. From the MAIN menu, select GROUPS. The AVAILABLE GROUPS menu appears.
2. Select a group’s label to which members are to be added. The PROGRAMMING OPTIONS menu appears, as shown in Figure 5-18.

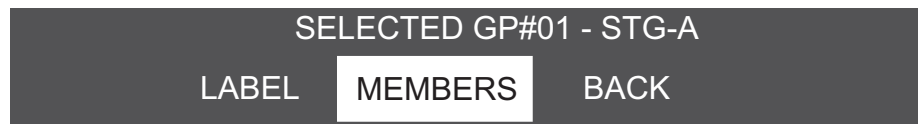

Figure 5-18: Group Programming Options Menu

3. Select MEMBERS from the menu.

The MEMBERS menu appears, as shown in Figure 5-19. On this set of pages, all of the base-station wired ports appear (HDSTA through PRGRM, “headset A” through “program”), followed by the labels for all twenty FreeSpeak beltacks. The menu header displays the number of members currently in the group out of a possible maximum of twelve members e.g. 4/12 for four members.



Figure 5-19: Adding Members to a Group

4. Scroll through the pages of this list to find the desired members for the group. When a desired member is highlighted, press the setup/enter knob to select that member. A box appears around it.
5. To de-select a member that has already been selected, highlight that member and press the setup/enter knob. Pressing the setup/enter knob effectively works as a toggle switch, first selecting the item by putting a box around it, and then de-selecting it and removing the box.
6. When all of the desired beltack labels and base-station port labels have been selected, scroll clockwise to BACK and select it to exit

Each beltack can accommodate six labels.

Each of the beltack’s three pages shows two labels.

the selection process. Continue selecting the BACK command until the desired screen is reached.

7. The changes are saved and applied automatically five seconds after the last time the setup/enter knob was pressed or turned. The front-panel display flashes to indicate that the changes are being saved and applied.

To edit a group that already has members, go through the procedure above to reach the member labels. Scroll through the list, using presses of the rotary encoder to select and de-select members. Exit as above, and save the changes in the system memory.

BELTPACKS

The following steps have been completed in setting up the system:

- Created names (“labels”) for the FreeSpeak beltpacks and for the devices wired to the base-station’s rear panel
- Created names (“labels”) for communication groups and assigned members to the each group.

The next step is to assign these communication routes to the individual FreeSpeak beltpacks.

For this example, communication routes are assigned to the beltpack in position one—BPK01. The procedure is identical for all remaining beltpacks.

1. Selecting the ‘BELTPACKS’ entry on the main menu displays the menus for configuring beltpacks on the basestation.

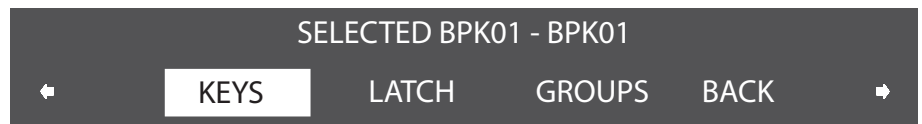

Figure 5-20: First Beltpack Menu

2. Use the Setup/Enter knob to scroll to the second beltpack menu.

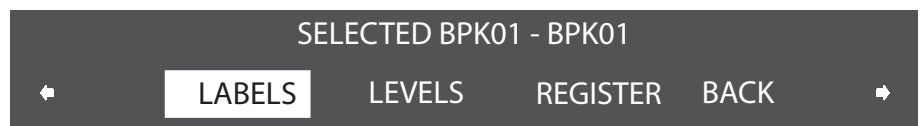

Figure 5-21: Second Beltpack Menu

ASSIGNING LABELS TO BELTPACKS KEYS

To assign talk and listen routes (“labels”) to a beltpack’s keys

1. From the MAIN menu, select BELTPACKS.
The AVAILABLE BELTPACKS screen is displayed.

2. Select the beltpack to which the labels are to be assigned. The BELTPACK menu is displayed.
3. Select KEYS. The KEY EDITING screen appears, as shown in Figure 5-22.

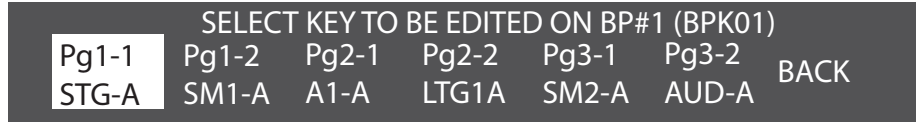
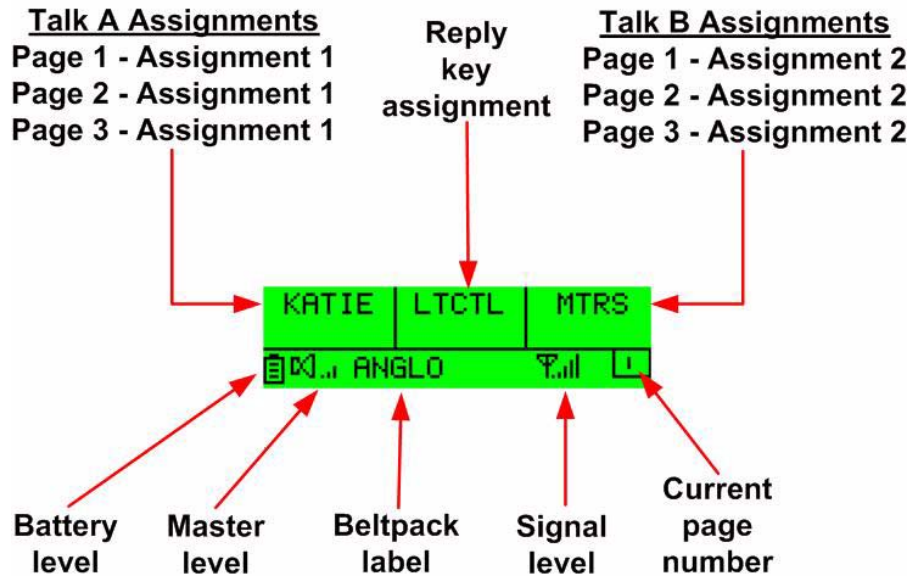

Figure 5-22: Assign communication routes (“labels”) to a beltpack key

Up to six communications routes (“labels”) can be assigned to a FreeSpeak beltpack depending on the number of key pages available on the beltpack:

- Page 1 of the beltpack’s display screen shows the first assignments for the Talk A and Talk B knobs (2 assignments).
- Page two shows the next set of assignments for the Talk A and Talk B knobs (2 assignments).
- Page three shows the next set of assignments for the Talk A and Talk B knobs (2 assignments).

Figure 5-23 shows how the front-panel screen on a beltpack displays its six communications routes.



Note: Use the beltpack’s scroll buttons to select a page. One page displays at a time on the front-panel display.

Figure 5-23: Beltpack Display

4. Select the beltpack key to assign a communication route to. For this example, it is the beltpack’s Talk A key, page 1.

A screen appears with a list of available sources and destinations to assign to this key. The list starts with the base-station 4-wire and party line connections, followed by each of the individual beltacks, and finally by the ten available groups (five standard groups and five wireless party line groups).



Figure 5-24: Select the source/destination to assign to that beltack key

5. Scroll through the list and select the desired source or destination to assign to that beltack key. A box appears around the selection and the next screen appears for assigning the key type.
6. Select either talk (TLK), listen (LIS), talk/listen (T+L), dual talk/listen (DTL), forced listen (FL) or talk/forced listen (TFL) for that key.

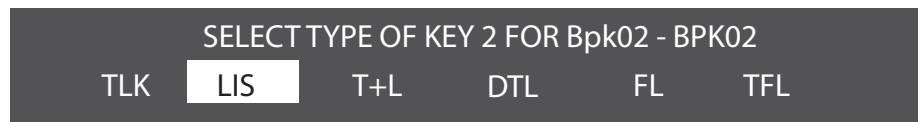

Figure 5-25: Key Type Menu

The display automatically returns to the screen for selecting the next key to program.

7. Select the next key and follow steps 4 through 6. Continue until sources and destinations have been assigned to all desired keys on that beltack.

To assign keys for another beltack continue selecting the BACK command on each successive screen until reaching the AVAILABLE BELTPACKS menu. Highlight and select the next beltack, and repeat the above procedures.

SETTING THE BELTPACK AUDIO LEVEL

1. From the MAIN menu, select BELTPACKS.
The AVAILABLE BELTPACKS screen is displayed (Figure 5-5).
2. Select the beltpack for which audio levels are to be set. The BELTPACK menu is displayed.
3. Select 'LEVELS'. The beltpack levels editing menu is displayed, as shown in Figure 5-26.

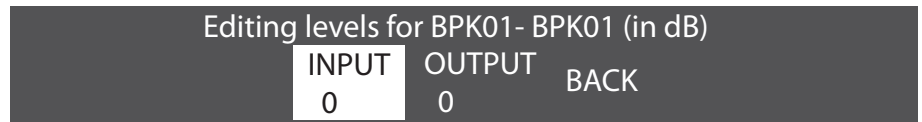

Figure 5-26: Beltpack Levels Menu

4. Use the Setup/Enter knob to select the input level to display the beltpack input level setup.

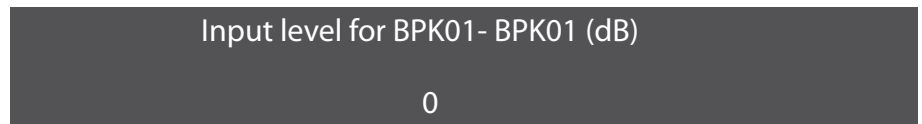

Figure 5-27: Beltpack Input Level Setup

5. Use the Setup/Enter knob to set the beltpack input level in the range -20dB to +6dB by rotating it anticlockwise to reduce the level and clockwise to increase the level. Press the Setup/Enter knob to select the input level.
6. Use the Setup/Enter knob to select the output level to display the beltpack output level setup.

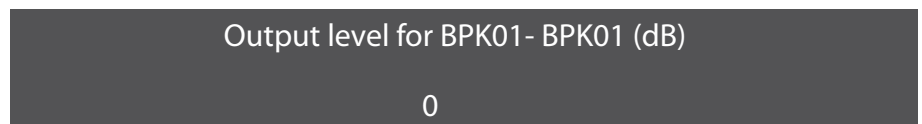

Figure 5-28: Beltpack Output Level Setup

7. Use the Setup/Enter knob to set the beltpack output level in the range -20dB to +6dB by rotating it anticlockwise to reduce the level and clockwise to increase the level. Press the Setup/Enter knob to select the output level.

SETTING BELTPACK LATCHING

Beltpack latching determines whether the beltpack A and B latch when pressed so that the user does not have to keep the button pressed to maintain an audio route, or are non-latching so the audio route is only open when the button is pressed.

1. From the MAIN menu, select BELTPACKS.

- The AVAILABLE BELTPACKS screen is displayed (see Figure 5-5).
2. Select the beltpack for which audio levels are to be set. The BELTPACK menu is displayed.
 3. Select 'LATCH'. The beltpack latching menu is displayed, as shown in Figure 5-29.

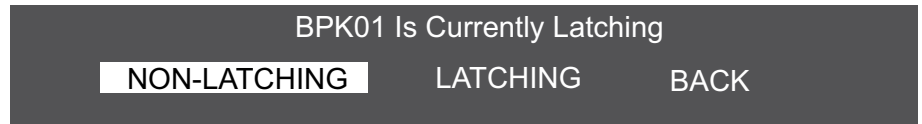

Figure 5-29: Beltpack Latching Menu

4. Use the Setup/Enter knob to select 'NON-LATCHING' or 'LATCHING' on the menu and press the Setup/Enter knob to set the latching status.

SETTING BELTPACK GROUPS

1. From the MAIN menu, select BELTPACKS.
The AVAILABLE BELTPACKS screen is displayed (see Figure 5-5).
2. Select the beltpack for which audio levels are to be set. The BELTPACK menu is displayed.
3. Select 'GROUPS'. The beltpack group editing menu is displayed, as shown in Figure 5-29.

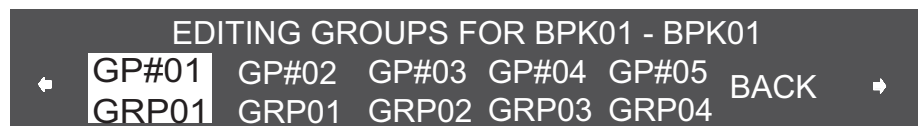

Figure 5-30: Beltpack Group Editing Menu

4. Use the Setup/Enter knob to scroll through the list of available groups and press the Setup/Enter knob to select a group. More than one group can be selected and each group that is selected will be indicated by a border.

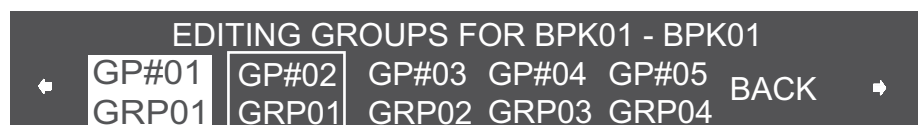

Figure 5-31: Beltpack Groups Selected

5. When all the required groups have been selected scroll to the 'BACK' item and press the Setup/Enter knob to return to the beltpack menu.

SETTING BELTPACK LABELS

1. From the MAIN menu, select BELTPACKS.
The AVAILABLE BELTPACKS screen is displayed (see Figure 5-5).
2. Select the beltpack for which audio levels are to be set. The BELTPACK menu is displayed. Scroll to the second beltpack menu using the Setup/Enter knob.

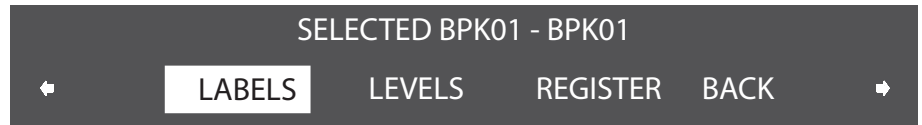

Figure 5-32: Labels Selected on the Beltpack Menu

3. Select 'LABELS'. The beltpack label editing menu is displayed, as shown in Figure 5-33.

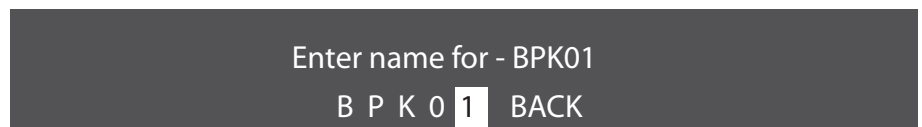

Figure 5-33: Beltpack Label Editing Menu

4. Scroll to and select the alphanumeric character to be changed. A box appears around the character.
5. Rotate the setup/enter knob. As the knob is rotated the entire range of available characters appears, starting with upper-case characters, proceeding to lower-case characters, then to digits, and finally to punctuation characters.
6. When the desired new character appears, press the setup/enter knob to select it. The box disappears, and is replaced by the solid highlight.
7. Repeat steps 4 through 6 for all the characters in the label that are to be changed.
8. When editing the label is completed select 'BACK' to return to the previous menu.
9. The changes are saved and applied automatically five seconds after the last time the Setup/Enter knob was pressed or turned. The front-panel display flashes to indicate that the changes are being saved and applied.

REGISTERING A BELTPACK

Beltpacks can be registered directly with a basestation from the front panel as well as using the Configuration Editor by entering the beltpack serial number.

1. From the MAIN menu, select BELTPACKS.
The AVAILABLE BELTPACKS screen is displayed (see Figure 5-5).

2. Select the beltpack for which audio levels are to be set. The BELTPACK menu is displayed. Scroll to the second beltpack menu using the Setup/Enter knob.
3. Select 'REGISTER'. The beltpack registration menu is displayed, as shown in Figure 5-34.

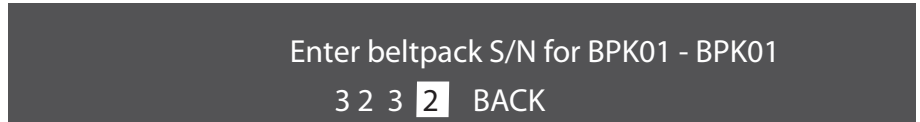

Figure 5-34: Beltpack Registration Menu

4. Scroll to and select the numeric character to be changed. A box appears around the character.
5. Rotate the setup/enter knob. As the knob is rotated the entire range digits 0 - 9 is displayed.
6. When the desired digit appears, press the setup/enter knob to select it. The box disappears, and is replaced by the solid highlight.
7. Repeat steps 4 through 6 for all the digits in the beltpack serial number.
8. When editing the label is completed select 'BACK' to return to the previous menu.
9. The changes are saved and applied automatically five seconds after the last time the setup/enter knob was pressed or turned. The front-panel display flashes to indicate that the changes are being saved and applied.

SETTING INPUT AND OUTPUT PORT LEVELS

The settings at the basestation determine the input and output audio levels of a device connected to a port. The user can adjust the levels from -20 to +6 dB.

- Setting the “input” level alters how loudly others will hear it.
- Setting the “output” level alters how loudly the user will hear other audio sources.

To set the audio level for a port

1. From the MAIN menu, select PORTS. A menu of the available audio ports is displayed.

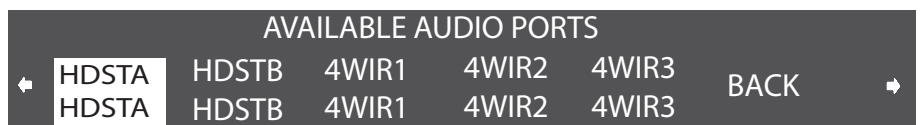

Figure 5-35: Available Audio Ports Menu

2. Select the port for which the audio levels are to be adjusted from the AVAILABLE AUDIO PORTS menu. The SELECTED PORT menu will be displayed.



Figure 5-36: Selected Port Menu for Level Setting

3. Select LEVELS from the next menu. The EDITING LEVELS menu appears.

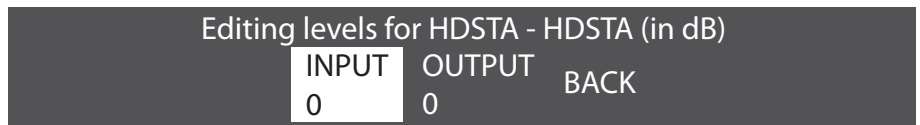

Figure 5-37: Port Levels Menu

4. Select either 'INPUT' to display the input level setup menu.

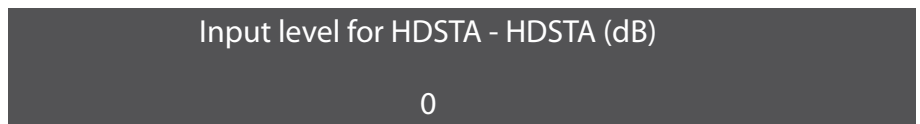

Figure 5-38: Port Input Level Setup

5. Rotate the setup/enter knob clockwise or counterclockwise to increase or decrease the input level in 1 dB increments.
6. When the desired audio level appears on the screen, press and release the setup/enter knob to select it,
7. The changes are saved and applied automatically five seconds after the last time the setup/enter knob was pressed or turned. The front-panel display flashes to indicate that the changes are being saved and applied.
8. Select either 'OUTPUT' to display the output level setup menu.

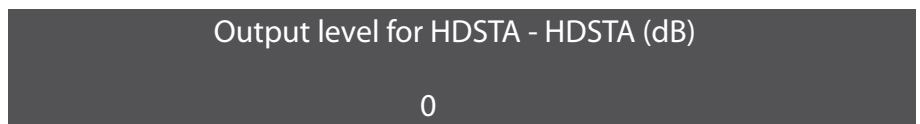

Figure 5-39: Port Output Level Setup

9. Rotate the setup/enter knob clockwise or counterclockwise to increase or decrease the output level in 1 dB increments.
10. When the desired audio level appears on the screen, press and release the setup/enter knob to select it,

11. The changes are saved and applied automatically five seconds after the last time the setup/enter knob was pressed or turned. The front-panel display flashes to indicate that the changes are being saved and applied.

In some cases, the audio paths must be re-made before the changes will take effect.

SETTING PORT CALL DESTINATION

Party Line, 4-Wire, Stage Announce and Program ports can also have call destinations configured. In this case any audio on the port will immediately be routed to the specified destination which may be any of the other available ports. If the VOX trigger is set then audio on this port will be routed to the destination when the specified threshold is exceeded.

1. From the MAIN menu, select 'PORTS'. A menu of the available audio ports is displayed.

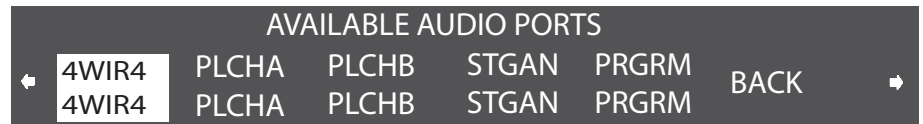

Figure 5-40: Available Audio Ports Menu

2. Select the port for which the call destination is to be set (excludes headset ports). The menu for the selected port will be displayed.

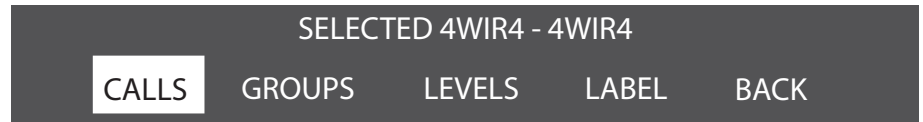

Figure 5-41: Selected Port Menu for Calls

3. Select 'CALLS' from the menu. The call destination menu will be displayed.



Figure 5-42: Port Call Menu

4. Use the Setup/Enter knob to scroll through the available ports and select the required destination port. It is possible to select the source port as the call destination to create an audio loopback system. This may be used for audio testing purposes.

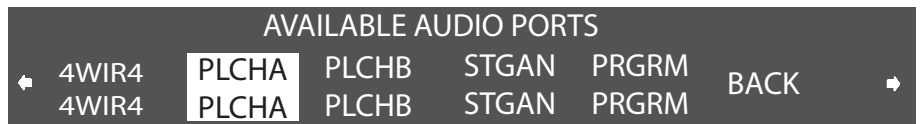

Figure 5-43: Port Destination Select Menu

5. The port destination can be cleared by repeating the process and selecting the 'NONE' entry.

If one of the headset ports (HDSTA, HDSTB) is selected the port menu is different in the 'KEY' is displayed rather than 'CALL'. This indicates that in order to trigger an auto route from the headset to the chosen destination the key on the basestation from panel should be used.

1. From the MAIN menu, select 'PORTS'. A menu of the available audio ports is displayed.

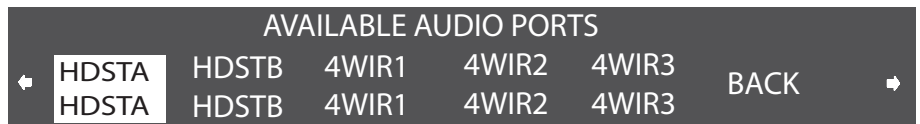

Figure 5-44: Available Audio Ports Menu

2. Select the port for which the call destination is to be set (excludes headset ports). The menu for the selected port will be displayed.

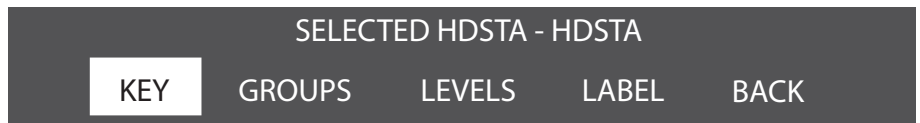

Figure 5-45: Selected Port Menu for Calls

3. Select 'KEY' from the menu. The audio destination menu will be displayed.



Figure 5-46: Port Call Menu

4. Use the Setup/Enter knob to scroll through the available ports and select the required destination port. It is possible to select the source port as the call destination to create an audio loopback system. This may be used for audio testing purposes.

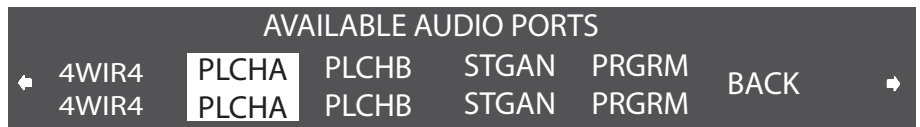

Figure 5-47: Port Destination Select Menu

5. The port destination can be cleared by repeating the process and selecting the 'NONE' entry.

CONFIGURING A PARTY LINE

Before enabling a party line from the basestation's front panel the type of party line must be set on the basestation so that it can set the proper termination, gain level, and call signalling for that system.

The three types of party line systems are: Clear-Com, Drake, and RTS.

To select the type of party-line system for a party-line port

1. Select PORTS from the main menu, then select PLCHA or PLCHB from the AVAILABLE AUDIO port menu which appears.
2. The port configuration menu is displayed. Scroll rightwards to display the second page of the menu.
3. Select TYPE. The first port type menu is displayed.

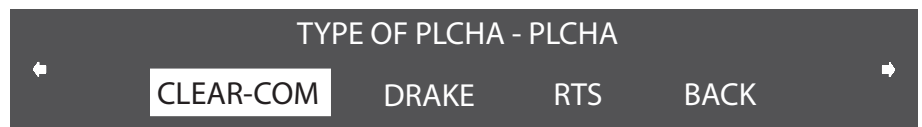

Figure 5-48: First Party Line Connection Type Menu

4. All the options on the first menu imply that the party line port will have termination enabled. If this is correct select either Clear-Com, Drake, or RTS. If the party line port should have termination disabled because the party line is already terminated by another device scroll rightwards to display the second party line type menu.

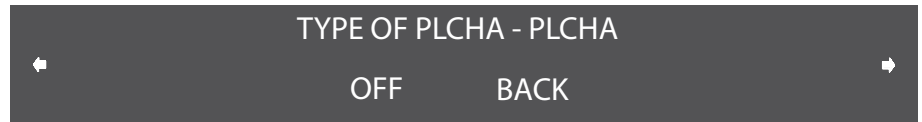

Figure 5-49: Second Party Line Connection Type Menu

5. Select 'OFF' to disable party line termination on the port. This will apply regardless of the type of party line connected to the port. For example if the party line is connected to an MS-702 master station with termination enabled the basestation termination must be disabled.
6. The changes are saved and applied automatically five seconds after the last time the setup/enter knob was pressed or turned. The front-panel display flashes to indicate that the changes are being saved and applied.

The basestation automatically sets the port's termination, gain, and call signalling options for the selected party line type.

To configure the noisegate for a party-line port

The noisegate sets a cutoff level below which audio input is ignored in order to avoid transmitting low levels of background noise. The noisegate can be set to a value in the range -70dB to -10dB when enabled.

1. Select PORTS from the main menu, then select PLCHA or PLCHB from the AVAILABLE AUDIO port menu which appears.
2. The port configuration menu is displayed. Scroll rightwards to display the second page of the menu.
3. Select GATE. The noisegate menu is displayed.

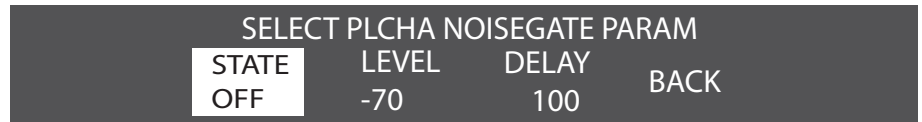

Figure 5-50: Party Line Noisegate Menu

4. Scroll to the 'STATE' option and press the setup/enter knob to display the noisegate state menu.

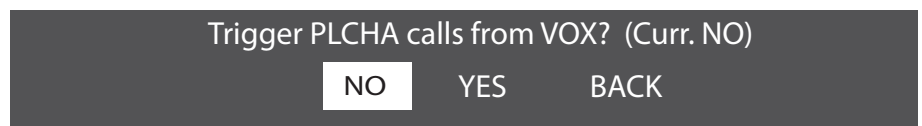

Figure 5-51: Party Line Noisegate Options Menu

Scroll through the options to enable or disable the noisegate and use the enter function to select the required state. The main noisegate menu will be redisplayed.

5. Select the level entry to display the party line level setup menu.

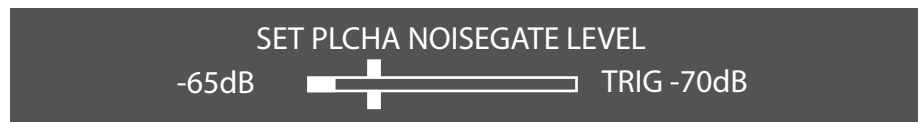

Figure 5-52: Party Line Noisegate Trigger Level

The vertical bar indicates the noisegate trigger level. Turning the setup knob clockwise increases the noisegate level (towards the maximum -10dB) and turning it anticlockwise reduces the noisegate level (towards -70dB). The horizontal bar indicates the current input audio level in real-time to assist in setting the noisegate level.

6. Select the 'DELAY' option on the noisegate menu to set the VOX off delay level. This allows the operator to set a delay in ms before audio is cut by the noisegate.

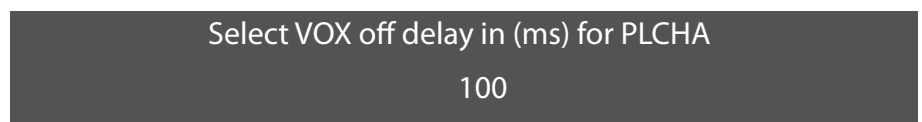

Figure 5-53: VOX Delay Setup

The VOX delay can be set to values between 50ms and 5000ms in 50ms steps. Turn the Setup knob clockwise to increase the delay and anticlockwise to reduce the delay.

To configure the levels for a party-line port

The Levels menu allows Input, Output and nulling levels to be set for a party line.

1. Select the party line port and then select 'LEVELS' from the party line menu to display the levels menu.

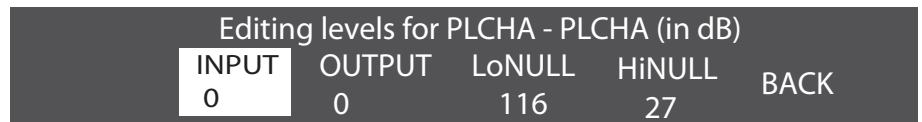

Figure 5-54: Level Editing Menu for Party Line

2. Select the 'INPUT' item to display the input level setup menu.



Figure 5-55: Party Line Input Level

3. Rotate the setup/enter knob clockwise or counterclockwise to increase or decrease the level in 1 dB increments between -20dB and +6dB.
4. When the desired audio level appears on the screen, press and release the setup/enter knob to select it,
5. The changes are saved and applied automatically five seconds after the last time the setup/enter knob was pressed or turned. The front-panel display flashes to indicate that the changes are being saved and applied.
6. Select the 'OUTPUT' item to display the output level setup menu.

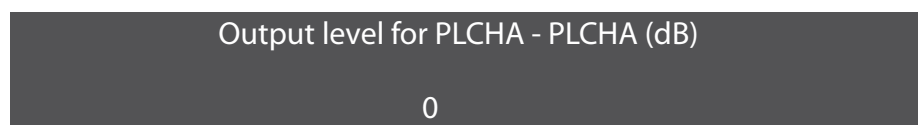

Figure 5-56: Party Line Output Level

7. Rotate the setup/enter knob clockwise or counterclockwise to increase or decrease the level in 1 dB increments between -20dB and +6dB.
8. When the desired audio level appears on the screen, press and release the setup/enter knob to select it,
9. The changes are saved and applied automatically five seconds after the last time the setup/enter knob was pressed or turned. The

front-panel display flashes to indicate that the changes are being saved and applied.

10. Select the 'LoNULL' item to display the output level setup menu.

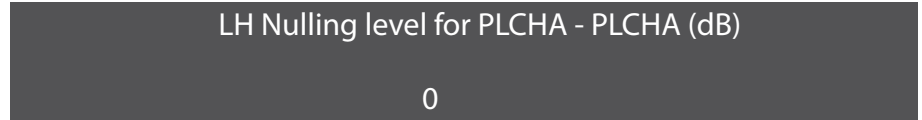

Figure 5-57: Party Line LoNULL Level

11. Rotate the setup/enter knob clockwise or counterclockwise to increase or decrease the nulling level in increments of 1 between 0 and 200.
12. When the desired audio level appears on the screen, press and release the setup/enter knob to select it,
13. The changes are saved and applied automatically five seconds after the last time the setup/enter knob was pressed or turned. The front-panel display flashes to indicate that the changes are being saved and applied.
14. Select the 'HiNULL' item to display the output level setup menu.

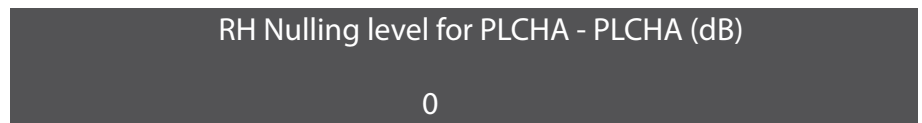

Figure 5-58: Party Line HiNULL Level

15. Rotate the setup/enter knob clockwise or counterclockwise to increase or decrease the nulling level in increments of 1 between 0 and 200.
16. When the desired audio level appears on the screen, press and release the setup/enter knob to select it,
17. The changes are saved and applied automatically five seconds after the last time the setup/enter knob was pressed or turned. The front-panel display flashes to indicate that the changes are being saved and applied.

BASESTATION SYSTEM MENU

The basestation SYSTEM menu offers several system-wide capabilities, including giving information on firmware, DECT system ID, IP address, and active antenna status, in addition to locking the front-panel enable buttons, remote microphone kill, and restoring the most recent downloaded configuration.

The left and right arrows at the edges of the display allow scrolling backwards and forwards between screens on the system menu.

From the MAIN menu, select SYSTEM. The SYSTEM menu appears as shown in Figure 5-59.

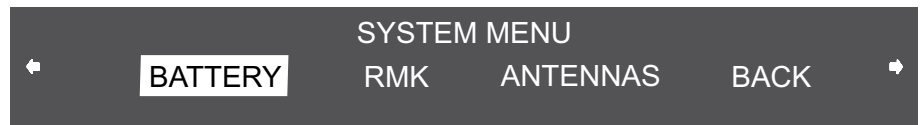

Figure 5-59: System Menu 1

Rotate the setup/enter knob clockwise to scroll through the list and display further options.

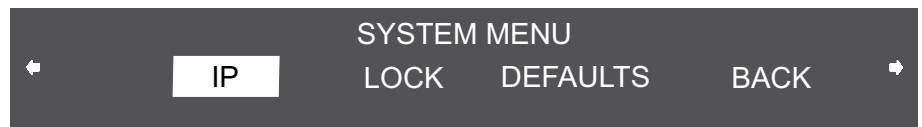

Figure 5-60: System Menu 2

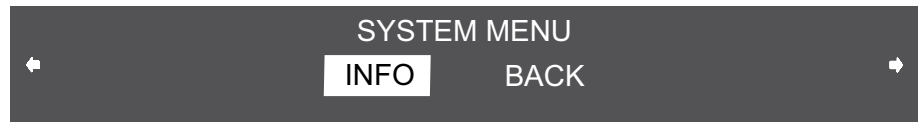

Figure 5-61: System Menu 3

The following sections describe the items on this menu.

SYSTEM INFO (“INFO”)

When INFO is selected the screen displays the system’s current firmware version, DECT system ID (for registering beltacks), and if applicable, IP address.

```
BUILD: JAN 21 2009 17:29:37 V2.0.0.037 => NEW FROM A
SYSTEMID: 100EC012 (A11)SYS:1      IPADDRESS: 129.67.61.36
CARRIERS: 0000 000300             RAM: 16MB FPGA:2.1
COPYRIGHT 2004-2008 VITEC GROUP COMMUNICATIONS
```

Figure 5-62: System Info Menu

To return to the SYSTEM menu, press the setup/enter button.

RESTORING THE DEFAULTS (“DEFAULT”)

When DEFAULT is selected a screen appears asking the user to confirm restoring the last configuration downloaded with reset applied. The default is ‘NO’. Select either yes or no.

```
Select map...
USER MAP  F.DEFAULT  BACK
```

Figure 5-63: Restore Defaults Menu

ANTENNAS (“ANTENNAS”)

When ANTENNAS is selected the display shows the status of the active antennas that are connected to the basestation, and shows the slots on each antenna that are occupied by beltacks. This information may be useful during a site survey, or when troubleshooting coverage areas or antenna connections.

A typical display is shown below:

```
1> --- --- --- --- ---      6> 1 --- --- --- ---      SYSTEM: 1
2> --- --- --- --- ---      7> 3 --- --- --- ---      TOTAL ONLINE: 4
3> 2  4 --- --- --- ---      8>
4>
5>                             9>
                             10>
```

Figure 5-64: ANTENNAS menu

The numbers 1 through 10 represent the maximum number of antennas that can be connected to the basestation. Numbers 1 through 5 can be positions on a splitter connected to transceiver port 1, while 6 through 10 can be positions on a splitter connected to transceiver port 2. An antenna connected directly to transceiver port 2 would appear at position 6.

“_” indicates an empty slot on an active antenna that is connected to the basestation. A number in place of a “_” indicates that this slot is occupied by the indicated belt-pack.

Blank spaces next to an antenna number indicate that no antenna has been detected in this position.

So, for example, the above display would indicate that five antennas are connected to the basestation in positions 1, 2, 3, 6, and 7. There are no active antennas in positions 4, 5, 8, 9, and 10.

There are 4 belt-packs currently connected. Belt-packs 2 and 4 occupy the first 2 slots of antenna 3; belt-pack 1 occupies the first slot of antenna 6; and belt-pack 3 occupies the first slot of antenna 7.

The display updates every 4 seconds to reflect changes in antenna status and belt-pack connections.

Rotate or push in the setup/enter knob to exit this menu.

SETTING THE IP ADDRESS (“IP”)

When IP is selected a screen appears allowing the IP address of the basestation to be set.

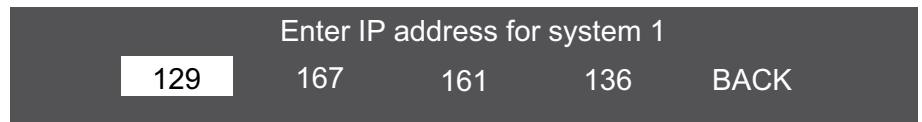

Figure 5-65: IP Address Menu

The IP address may be changed by use of the Enter/Setup rotary encoder. The current part of the IP address that will be changed is highlighted and slowly rotating the encoder increases the IP address in increments of 1 per step whilst rapidly rotating the encoder increases the IP address in increments of 10 per step. When the required value is set press the encoder to confirm it and then rotate the encoder one step to select the next part of the IP address and repeat the procedure.

When the required IP address has been set select 'BACK' to save the IP address and exit the menu.

To exit without saving any changes to the IP address allow the menu to timeout (about 30 seconds).

LOCKING FRONT-PANEL ENABLE BUTTONS ("LOCK")

When LOCK is selected a menu appears that allows the user to lock the front-panel enable buttons for party-line channel A, party-line channel B, and the wired program source.

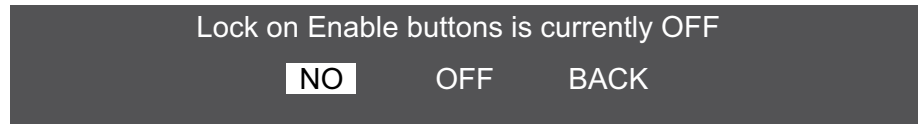

Figure 5-66: Lock Enable Menu

Selecting ON for the lock maintains whatever state the buttons are in when they are locked. That state is maintained even when the basestation is turned off and re-started. The buttons can be locked either in the enabled or disabled position, in any desired combination.

Selecting OFF allows the buttons to be toggled on and off with a single push.

REMOTE MICROPHONE KILL ("RMK")

When RMK is selected the remote microphone kill menu will be displayed.

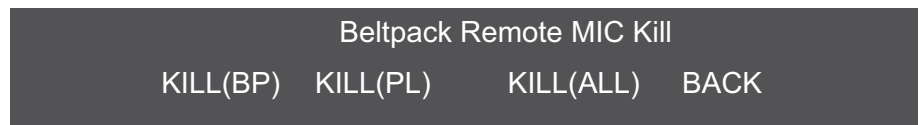

Figure 5-67: Remote MIC Kill Menu

Kill Beltpack Microphones ("KILL(BP)")

Selecting this function will kill the microphones on all the wireless beltpacks connected to the basestation. Beltpack users will have to press a talk key again to re-enable the beltpack microphone.

Kill Party Line Microphones ("KILL(PL)")

Selecting this function will kill the microphones on all the party line stations connected to the basestation. As this operates by interrupting the power to the party line stations it does not kill microphones on party line stations that are externally powered .i.e not powered from the FreeSpeak basestation.

Kill All Microphones (“KILL(ALL)”)

Selecting this function will kill the microphones on all belt packs and party line stations attached to the FreeSpeak basestation other than party line stations that are externally powered.

Belt pack and party line users must press a talk button in order to re-enable microphones afterwards.

BATTERY INDICATOR (“BATTERY”)

Selecting the “BATT” function will display the battery life monitor screen.

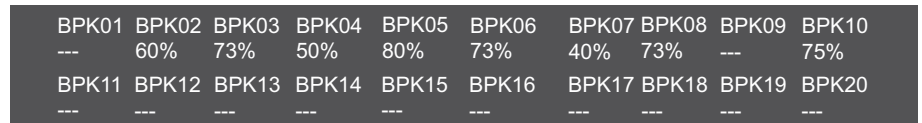

BPK01	BPK02	BPK03	BPK04	BPK05	BPK06	BPK07	BPK08	BPK09	BPK10
---	60%	73%	50%	80%	73%	40%	73%	---	75%
BPK11	BPK12	BPK13	BPK14	BPK15	BPK16	BPK17	BPK18	BPK19	BPK20
---	---	---	---	---	---	---	---	---	---

Figure 5-68: Battery Level Menu

The line below the title line is battery monitor that shows the battery levels of all belt packs that are connected to the basestation. When the battery level of a belt pack drops to the alarm level and the battery low alarm is triggered the display for that belt pack will be displayed highlighted.

6

OPERATING THE FREESPEAK WIRELESS BELTPACK

OVERVIEW OF THE WIRELESS BELTPACK

The user can access six separate audio routes from a beltpack.

Depress the channel A or B talk button to select an audio route. Turn the button to adjust volume.



Figure 6-1: Overview of Beltpack Functions

A FreeSpeak wireless beltpack gives the user simultaneous access to six channels of talk/listen communication, with the ability to switch among them as desired. Any or all of these six routes may be kept open during use. Incoming volume levels (“listen levels”) may be

Any or all of the beltpack's six audio routes may be kept open while the user talks or listens on the beltpack.

individually adjusted using the two push-to-talk knobs, so that one conversation can be monitored in the background while a primary conversation is held.

The front-panel display contains the name (label) of the beltpack user, identifies the two talk/listen labels currently selected by the user, and gives other information such as signal strength and battery level.

A 4-pin male headset connector is provided for connection with a standard Clear-Com headset or similar. The FreeSpeak beltpack will operate for approximately 8 hours on four AA alkaline or rechargeable NiMH batteries. Real operational times depend on usage and quality of batteries used.

BELTPACK TOP CONTROL SECTION



Figure 6-2: View of Top of Beltpack

① Talk Knobs, Channels A and B

The talk knob functions as a volume control for incoming audio assigned to channels A and B. Turn the knob clockwise to increase the volume, and counterclockwise to decrease it.

To talk or listen on a channel, press and hold the knob down while speaking or listening from the headset. While the knob is held down audio transmits on that channel. When the knob is released audio no longer transmits.

To "latch" a knob "on" for hands-free use, quickly tap the knob. Another quick tap releases the latch.

② Level-Control Lights, Channels A and B

Three level-control lights are located next to each talk knob. The first light is green, the second is yellow, and the third is red. With the knob turned fully counterclockwise, only the green LED is lit to indicate low volume. Turning the knob clockwise, low audio level is heard in the headset. Turning the knob more, both the green and yellow LED's light, and higher audio level is heard. This continues through the maximum audio level, indicated by only the red light being lit.

③ Talk/Listen Lights, Channels A and B

The green "listen" light blinks whenever a beltpack receives audio from a source whose label is displayed on the beltpack's LED screen. When the talk button is pressed to "talk" the green light illuminates steadily and the red light also illuminates.

④ Answer-Back Lights

The green and red lights labeled "answer" illuminate when a source who is not on the beltpack's presently selected communication routes tries to initiate a call. The green light flashes when a call is coming in. By pressing the answer-back button on the front of the beltpack the user can talk to the source. The green LED then lights steadily and the red LED lights, until the conversation is ended by again pushing the answer-back button.

⑤ Combo Button

Pushbutton A/B and pushbutton C form a combo key that when pressed will call whichever destination has been selected on the beltpack. The call receiver will be alerted by a call signal or the beltpack vibration or both depending on the alert options selected at the receiving end.

BELTPACK FRONT/DISPLAY SECTION



Figure 6-3: View of Front of Beltpack

① Backlit LCD Display

The display screen shows the various communications routes and other information relevant to the beltpack. The backlighting comes on when any action is taken with the scroll or enter buttons, and remains on for approximately 10 seconds. During the answer-back process, the label of the source is displayed in the lower center of the display.

② Left and Right Scroll Buttons

When the left and right scroll buttons are pressed the beltpack's display screen scrolls to the left or right, displaying "pages" of information, and menu options on those pages. These buttons work in conjunction with the enter button, described below.

③ Enter/Answer-Back Button

The enter/answer-back button has two primary purposes. When the user views the menus on the beltpack's display screen an option can be selected by pressing this button. The user can exit a menu by selecting the up-arrow icon. In this way, the button serves as an enter key.

During normal beltpack operation it functions as the answer-back key, with which the user can activate a talk to an unassigned source when

the answer-back “talk” light illuminates to indicate an incoming call (see description in “Beltpack Top Control Section” above).

BELTPACK BATTERIES

BELTPACK REAR/BATTERY SECTION

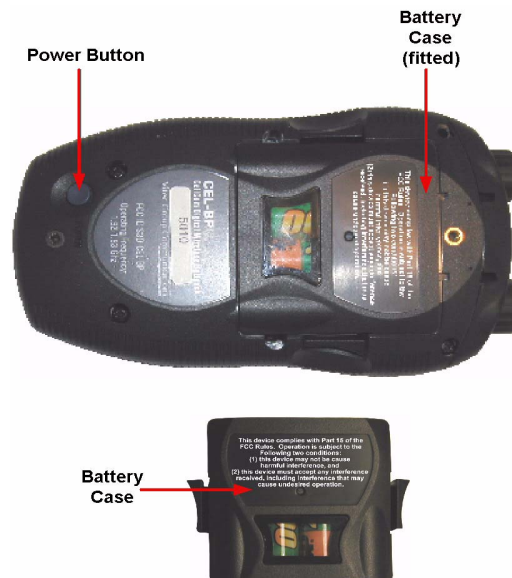

Figure 6-4: View of Back of Beltpack

① Power Button

The recessed power button is used to turn the FreeSpeak beltpack on and off. Press and hold the button for about three seconds to turn the unit on. To turn the unit off, again press and hold the button for about three seconds.

② Battery Case

The removable battery case will hold four alkaline AA or four NiMH (nickel-metal hydride) rechargeable batteries. These batteries alternate, with the negative pole contacting the spring and the positive pole contacting the plate inside the case.

To remove the battery case, press on the top of the belt clip to lift it off the case, and with the thumb and middle or ring finger of the other hand squeeze the side tabs of the case and lift it out, slightly tilting the lower (toward the bottom of the beltpack) portion of the pack out first.

To insert the battery pack, follow the above instructions in reverse. Note that the battery case has a clip-on lower cover; make sure to put it back in place before putting the battery case back into the beltpack.

Caution: Do not put battery packs containing alkaline batteries into a recharger, or recharge them in the beltpack. Serious damage or injury could result.

③ Belt Clip

The belt clip is spring-loaded with enough tension to hold the beltpack to the user's belt and against the hip. Note that the upper portion of the rear of the beltpack connected to the belt clip is a separate piece; the entire belt clip assembly may be replaced in case of damage.

BELTPACK BOTTOM CONNECTOR SECTION



Figure 6-5: View of Bottom of Beltpack

① Data Connector

This 3.5 mm (1/8 inch) tip-ring-sleeve (TRS) connector is used to connect the beltpack to a computer in order to identify the beltpack to the basestation during initial registration and system setup. It may also be used if an upgrade to the beltpack firmware is ever required in the future, to add new features and capabilities. See the section "Registering the Beltpack with the Basestation" for further details.

② Headset Connector

The male 4-pin headset connector provides audio pathways for the headset microphone and headset earpiece(s). This connector supports all Clear-Com and compatible headsets using female 4-pin connectors. It will support dynamic microphones.

③ Battery Recharger Connector

The FreeSpeak beltack features an internal battery charger to charge the four AA-format NiMH batteries used to power the unit. The recharger circuit includes a thermistor that senses the temperature of the battery pack to prevent overcharging. To use this internal recharger, plug in the small barrel connector on the supplied universal power supply into the beltack connector, and then plug the supply into the local AC current. The beltack will automatically shut off when the charging PSU is plugged into it. While it is charging, the beltack cannot be turned on. The unit can only be turned on when the charging PSU is disconnected. A full charge takes approximately 3 to 4 hours depending on the battery capacity. After this time, the charger will maintain a trickle charge to keep the beltack fully charged.

FreeSpeak beltack usage time is dependent upon the batteries used. Some batteries require more charge/discharge cycles than others to reach their rated capacity.

Caution: Do not put battery packs containing alkaline batteries into a recharger, or recharge them in the beltack. Serious damage or injury could result.

BELTPACK TURN-ON SEQUENCE

After pressing the POWER button on the rear of the beltack for approximately three seconds, the top control panel LEDs will flash and the display will light. The display will say "Clear-Com" and "Searching...". It may briefly say "Getting Roles," and then will go to the main user screen.

The beltack will always begin on page 1 (unless it has been locked to another page), which has the first two communication routes assigned to the beltack. When programming communication routes for the users in the system, it is best to put the most commonly used ones on this page.

BELTPACK TURN-OFF SEQUENCE

To turn off the beltack, press and hold the POWER button on the rear of the beltack for about three seconds. The main screen will close, followed by a screen that says "FreeSpeak" and "Shutting Down."

POWERING THE FREESPEAK BELTPACK

The supplied battery pack holds four AA-sized batteries. Standard AA alkaline batteries will provide between 7 and 8 hours of typical use. The batteries alternate in the battery case, with the spring on the negative end and the tab on the positive end.

For best performance, use fresh alkaline batteries that have been properly stored and kept away from excessive heat. As with all other

battery-powered electronic items, when the FreeSpeak beltpack is stored for extended periods of time, remove the batteries to prevent damage from possible leakage of the alkaline cells.

Caution: Make sure that FreeSpeak battery packs loaded with alkaline batteries are not put into a battery charger, or that the internal beltpack charger is used to attempt to charge them. Damage and possible injury will result.

Rechargeable AA-size NiMH (nickel-metal hydride) batteries may be used with the FreeSpeak beltpack. Select good quality batteries with high amperage ratings for the best and longest performance. These batteries will last for many charge cycles, and will power the beltpack for approximately 8 hours.

If the batteries are being charged twice daily, then the battery lifetime would be approximately 8 months or approximately 500 charge cycles. It is recommended that the batteries be replaced every 4-5 months in these circumstances (near the end of their service life) as NiMH batteries can become less efficient with time and may develop an internal short circuit.

The beltpack charger defaults to trickle charge once the batteries are fully charged, but some battery manufacturers state a maximum overall charge time of 20 hours.

Note: If the batteries are hot prior to charging then they will switch to trickle charge too early in the charge cycle when the Cel-FS-Charger is used (the green light will come on).

Never mix discharged batteries and fully charged batteries in the same pack and never mix batteries of different types as this can damage the charger.

Batteries should not be left in a beltpack and connected to a charger for more than 20 hours.

Note: FreeSpeak beltpack usage times are dependent upon the batteries used. Some batteries require more charge/recharge cycles than others to reach their rated capacity.

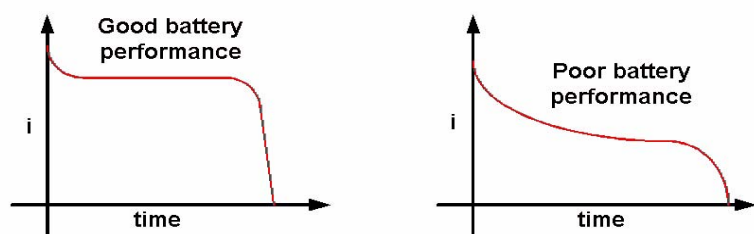

Figure 6-6: Battery Discharge Characteristics

The beltpack front-panel display has an icon that shows the battery condition. It has five vertical bars to signify the remaining charge, each bar representing 20% of battery capacity. When the icon has dropped down to the last two bars, or if it drops quickly after being turned on after previous use, it will be time in the next few minutes to recharge the batteries (if rechargeable ones are being used) or replace them. The beltpack will turn off by itself at low battery levels.

The length of operational time represented by each bar will depend on how the beltpack is being used. For example, if the beltpack is receiving a large number of calls with the vibrate call alert enabled this will consume more power than if the beltpack is switched on but not making or receiving many calls. The battery indicator will however give a visible indication of how rapidly the batteries are discharging.

Within the menu structure of the beltpack, a low-battery alarm is available and may be set. When activated and when the battery level is below the user configurable alarm threshold the headset user will hear a beep at intervals and the battery indicator will flash to indicate that the batteries must be replaced or recharged soon. This setting is available under Alarm Options. The alarm will also be displayed on the basestation battery monitor.

The FreeSpeak beltpack features an internal battery charger circuit, with intelligent circuitry to prevent overcharging. It is powered via the pin connector on the bottom of the beltpack, using the supplied universal power supply. A thermistor (temperature-sensing device) measures the change in temperature of the battery when charging, letting the circuit know when to cease charging the batteries.

Spare clips of four batteries are available by contacting the Sales Department.

REGISTERING BELTPACKS WITH THE BASESTATION

The PC-to-Beltpack serial cable is used to upgrade the firmware of the beltpacks and to register beltpacks using the FreeSpeak Configuration Editor.

For instructions on registering beltpacks with the basestation, and for upgrading the firmware, see the chapter *“FreeSpeak Configuration Editor”*.

The cable consists of a female 9-pin D type connector (PC connection) and a 3.5 mm (1.8-inch) stereo jack plug (beltpack connection). Care must be taken to select a jack plug that fits completely through the plastic surround of the connector at the bottom of the beltpack.

The data connections between the D connector and the stereo jack plug are as follows: pin 2 to tip, pin 3 to ring, and pin 5 to sleeve. Pins 1,4,6 and 8 on the PC connector are shorted together, as with the PC to basestation cable.

REMOVING REGISTERED BELTPACKS FROM THE BASESTATION

Belpacks can be removed from the basestation and new ones substituted with the FreeSpeak Toolkit program. Refer to the chapter “FreeSpeak Configuration Editor” for more information.

ACCESSING THE TALK/LISTEN PATHS ON THE FREESPEAK BELTPACK

The user can access up to six communications routes with a belpack. A route is activated by pressing the appropriate talk button (A or B) when the desired label appears on the belpack’s display.

- Page 1 of the belpack’s display screen shows the assignments for the Talk A and Talk B buttons (2 assignments).
- Page two shows the next set of assignments for the Talk A and Talk B buttons (2 assignments).
- Page three shows the next set of assignments for the Talk A and Talk B knobs (2 assignments).

Figure 6-7 shows how the front-panel screen on a belpack displays its six communications routes.

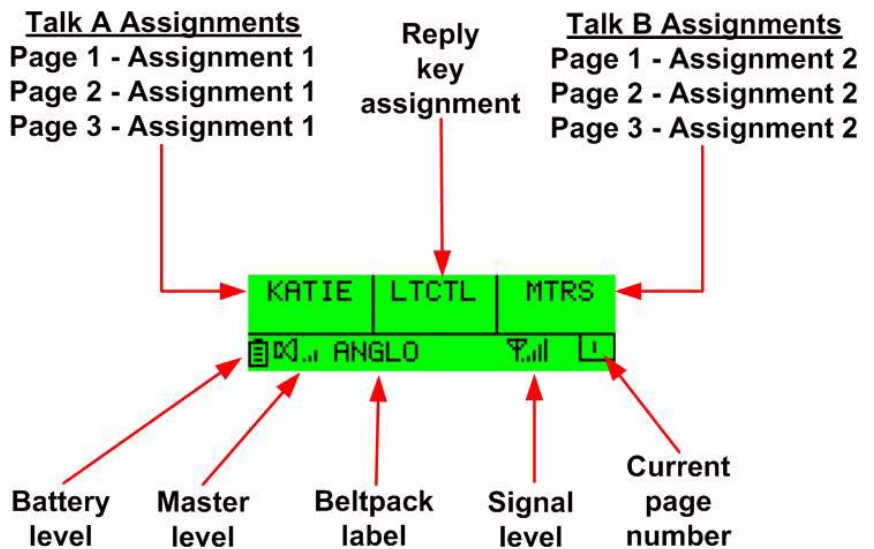

Note: Use the belpack’s scroll buttons to select a page. One page displays at a time on the front-panel display.

Figure 6-7: How the belpack displays its six communication routes

The case of a label on the belpack indicates its assignment type:

- All uppercase - Talk

- First letter in uppercase, rest lowercase - DTL
- All lowercase - Listen

To activate a talk or listen to an assigned source or destination (“label”)

1. Use the beltpack’s scroll buttons to scroll to the page on which the desired assignment (“label”) appears. The beltpack holds three pages of assignments. Each page displays two assignments. As the display is scrolled “beeps” will be heard in the headset that correspond to the page displaying on the beltpack: 1 beep for page 1, 2 beeps for page 2, etc.
2. When the appropriate page is reached select one or both of the assignments on that page by depressing the corresponding talk buttons on the beltpack (A or B).
3. Press and hold the appropriate talk button to talk or listen to the destination. Release the button to close the talk or listen path. Alternatively quickly tap the talk button to latch it “on”. Quickly tap it again to release the latch.
4. To activate another communication route, repeat steps 1 through 3.

It is possible to keep all six communication routes “open” at the same time. All activity on these routes will be heard in the headset.

Note: Two-wire and four-wire devices can have dual talk-and-listen or just listen assignments.

SETTING AND ADJUSTING LISTEN LEVELS

A beltpack’s incoming audio volume (“listen level”) can be adjusted in two ways:

- The overall maximum level for the beltpack can be set by using the beltpack menu options.
- The incoming audio level can be adjusted during talk or listen on the beltpack using the beltpack’s talk buttons.

To adjust the overall maximum “listen level” for a beltpack

1. From the beltpack’s display, scroll to Audio Options, then Headset Options, then Master Level.
2. Select Master Level by pressing the enter button.
A bar graph appears on the display.
3. Using the right and left scroll keys, adjust the level up or down as desired on the bar graph.
Typically, the level control will be set to around 2/3 of maximum.
4. When the desired level is reached, press the enter button.
That selection is saved in the beltpack’s memory. The display returns to the previous screen.

To adjust the listen level during talk or listen from the beltpack

- During talk and listen, rotate an assignment's talk button to increase or decrease the incoming volume level ("listen level") for that assignment.
- When scrolling between pages, the listen levels for the various assignments remain intact. For example, rotating the talk button to increase or decrease the listen level for the first assignment on page 2 will not affect the listen level set with the same talk button on page 1 or 3.
- The three lights next to each talk button, labeled "Vol A" and Vol B," show the current listen level. At the lowest audio level, the green light illuminates. As the listen level increases to moderate, the yellow light illuminates, and as it increases to maximum, the red light illuminates. Note that the position of the talk button does not affect the level that is heard or indicated by the lights.

Note: For beltpacks that have both a Direct Key to a panel and a Group Key containing the same panel as the Direct Key the Direct Key will affect the listen volume level in that Group. If the listen volume of the Direct Key to the panel is turned down to -70db/silent and then removed from the beltpack then listening to the group key containing that panel will now result in the panel volume being set to -70db/silent.

HEADSET LIMITER

The overall headset volume may also be affected by the headset limiter value set on the beltpack. See section "BELTPACK MENU OPTIONS" for more details.

USING THE BELTPACK ANSWER-BACK FUNCTIONS

A beltpack's "answer-back" key performs two functions:

The first function is to answer a call from a source whose "label" does not appear on the currently selected beltpack page.

When audio is received from a source whose label does not appear on the currently selected beltpack page, but whose label does appear on a non-selected page, the beltpack's "answer-back" light will flash. The user will also hear the caller's voice in the headset at whatever incoming volume was previously set for that label.

This call can be answered in one of two ways:

- Press the front-panel "answer-back" button on the beltpack. This establishes a return talk path to the calling beltpack. Press and hold the button to talk or quickly tap the button to "latch" it on.
- Use the front-panel scroll buttons to scroll to the page where the source's label appears and press the appropriate talk button as usual.

The second function is to call another beltpack even though it does not have the same “label” assigned to it that is assigned on the local beltpack. The destination beltpack’s “label” must be assigned to the local beltpack however to make this type of call.

For example, a stage manager labeled “STMGR” has a lighting crew member’s label “LGT1” assigned to the “STMGR” beltpack. However, the lighting crew member does not have the stage manager’s label assigned to the “LGT1” beltpack.

The stage manager can call the lighting crew member in the usual way. The lighting crew member can answer the call with the “answer-back” button and establish a private conversation. The lighting crew member cannot however initiate a direct call back to the stage manager.

BELTPACK MENU OPTIONS

The FreeSpeak beltpack presents the user with a number of adjustable parameters. The main categories of the adjustments are: Alarm Options, Audio Options, View Status, and Adjust Contrast accessed through the menu. To enter menu mode hold down both page buttons simultaneously until the beltpack enters menu mode (about 5 seconds).

An icon of an upward pointing arrow designates EXIT or BACK, and is available on each menu page. Selecting this icon and pressing the center ENTER button takes the user to the previous screen or exits to the beltpack’s main menu.

ALARM OPTIONS

Low Battery Alarm

The low-battery alarm has three settings: ON1, ON2 and OFF. Using the scroll keys, select the desired setting and then press the center ENTER key.

- When ON is selected the user will hear a beep at intervals in the headset to indicate that it is time to replace or recharge the beltpack batteries. This will occur when the battery level is sufficiently low. The battery indicator will also flash.
- When ON2 is selected the threshold setting is used to trigger the alarm.
- When OFF is selected the user will not be warned of low battery level.

Low Signal Alarm

The low-signal alarm has two settings: on and off. Using the scroll keys, select the desired setting and then press the center ENTER key.

- When ON is selected the user will hear a beeping in the beltpack's headset when the beltpack is almost out of the range of the antenna, and will soon lose connection with the system.
- When the beltpack's signal-level icon is at the second-lowest increment the user will hear one quick beep and two slightly longer beeps at approximately one-second intervals in the headset. The user will hear the same beeps when going completely out of range and connection is lost with the antenna (and the basestation).
- This setting may be especially useful when establishing the coverage area for a particular location. Because the signal level when the alarm is first activated is still strong enough for conversations to happen (though possibly with occasional audio dropouts), it may not be desirable to keep this alarm on during normal operation of the system. This low signal alarm is also useful for checking out the coverage in a location when first setting up transceiver/antennas, for either a temporary or permanent installation.
- When OFF is selected the low signal alarm does not operate.

AUDIO OPTIONS

Headphone-Off Level Option

This option allows the user to select the signal threshold when the headphone audio "turns off." Level settings are -6, -12, -18, and -70 dB. The typical setting is -70 dB, which functions as "always on."

Page Lock Option

When the Page Lock option is selected the page change keys no longer operate.

Headphone Limiter Option

This option introduces a limiter into to headphone audio circuitry, to control excessive levels and resulting stress on the ear of the user. The level can be set anywhere in the range -32dBu to +16dBu using the Headphone Limiter display on the beltpack. The typical setting is -6 dBu.

Microphone Type Option

This option allows the user to select the proper setting for the headset microphone. The available settings are Dynamic (Balanced) Mic and Dynamic (Unbalanced) Mic. For most Clear-Com and other headsets, the Dynamic (Unbal) Mic setting is proper.

Microphone Level Option

This option allows the user to set the level of the beltpack's headset mic, increasing or decreasing its gain going into the system. For Type I beltpacks the gain settings are 40, 50, and 60 dB, for Type II beltpacks the gain settings are 50, 55, 60 and 65 dB. The typical setting is 50 dB.

Headset Options

Two headset options are offered:

- Master Level
- Sidetone Level

The Master Level control accesses a slide bar going from “-“to “+”, and controls the overall maximum level that can be heard through the headphones. This gain control permits adjustment among headsets with different sensitivities, and for different use conditions (quiet studio versus loud live performance environment). Typical setting is 2/3 to 3/4 of the way toward “+”.

Sidetone Level controls the amount of the user's own voice (local sidetone) that is injected into the headphone from the headset mic. It is activated when the user pushes a talk button or an answer-back key to alert the user that the microphone is on. If a talk button is not pressed no sidetone will be heard.

VIEW STATUS

Role Information

Role Information gives the label (user name) that has been assigned to the particular beltpack, and also gives a numerical Role Number which the system uses – typically starting with 700 for the first beltpack and going up from there.

Beltpack Version

Beltpack Version gives the current software version on the beltpack, and a CRC number. Use these numbers to determine whether a beltpack contains the latest software version, and to confirm the success of a software upgrade.

Beltpack ID

Beltpack ID, also known as IPEI, gives the unique identification number for the transceiver in the FreeSpeak beltpack.

RF Carrier Mask

The RF carrier mask tells the basestation and beltpacks which of the standard DECT carrier frequencies to use. In Europe, for example, the

standard carriers 0 to 9 (1880 to 1900 MHz) are designated as "0x03FF000000." Other parts of the world, such as South America, use Extended Carriers, such as 18 to 27 (1910 to 1930 MHz), designated as "0x0000007FE0." The DECT stacks in both the FS-TA transceiver/antenna and the FS-BP beltpack must be told which group of 10 carrier frequencies to use via the "mask," when they are first initialized.

Connection Info

Connection Information defines all of the various DECT information for the beltpack transmission and link to the transceiver/antenna. It also gives the Carrier Number and Slot that the beltpack is currently using (this can dynamically change as needed during use). In addition, the Received Signal Strength Indication (RSSI) is numerically indicated, with 55 being the highest value; also, the error percentage is shown.

Adjust Contrast

Adjust Contrast provides a slide bar going from "-" to "+", allowing the user to adjust the contrast on the display. Typical range is between 1/2 and 3/4 toward "+".

7

PROGRAMMING AT THE BELTPACK

INTRODUCTION TO PROGRAMMING ON THE BELTPACK

In programming the Beltpack, the general considerations are:

- It is necessary to have a radio connection to be able to engage programming mode. It is not generally possible to enter programming mode unless the normal working display is present.
- To access the main programming menu, hold both the UP and DOWN keys pressed together for at least 3 seconds. This calls up the main programming menu.
- The Beltpack saves programming data when enter is pressed on a menu which does not have an UP arrow at the right hand end. To exit without saving, press the UP and DOWN buttons simultaneously for 3 seconds.
- Generally buttons auto-repeat when held pressed.
- The "cursor" is the highlighted item and it cycles round to the other end of the menu when it reaches one end.
- The icon shown in a box is the currently selected item.
- If the right hand end of the menu contains an UP arrow, selecting this and pressing Enter will take the user back up one level in the menu structure and will eventually return the user to the main working display.
- The backlight times out after 15 seconds.

The menus in Program Mode are presented graphically as a menu map.

BELTPACK PROGRAMMING - MENU STRUCTURE

On the menu structure below, the flow is downwards and to the right unless indicated otherwise.

MAIN PROGRAMMING MENU

This is the main menu for programming the Beltpack.

This menu is reached by holding both the UP and DOWN keys pressed for at least 3 seconds. To return to normal operation, select Exit (the Up arrow on the display) and press pushbutton C.

To navigate around any menu, use the UP and DOWN scroll buttons to highlight the required item (the highlighted item is shown in inverse video). Then press Pushbutton C (effectively the "Reply/Answerback" key in normal mode or "Enter" key when in Program Mode) to implement the selection.

- Main programming menu showing the Master Level option selected.



This option allows the master volume level to be set in the range -12dB to 0dB using the scroll buttons.

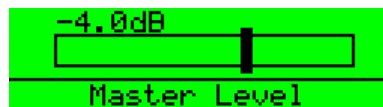

- Main programming menu showing the Settings option selected.



- Main programming menu showing the Button Options selected.



- Main programming menu showing the Information (Status) option selected.



- Main programming menu showing the Page Options selected.



- Main programming menu showing the Exit (from Program mode to normal operation) option selected.



THE ALARM OPTIONS MENU

This is the Alarm menu for determining whether the low battery and/or low signal strength warnings should sound in the headphone.

This menu is reached by selecting the Alarm option on the main programming menu.



To return to the main programming menu, select Exit (the Up arrow on the display) and press pushbutton C.

- The Alarm menu showing the low battery warning option selected.



- Press button C to select the low battery alarm menu and use the scroll buttons to switch between the low battery alarm settings.
- The Alarm menu showing the low signal strength warning option selected.



- Press button C to select the low signal alarm menu and use the scroll buttons to switch between the low signal alarm settings.
- The Alarm menu showing the Vibrate option selected (Type II beltpacks only).



- Press button C to select the vibrate alert menu and use the scroll buttons to switch between the vibrate alert settings.
- Exit the Alarms menu by using the scroll buttons to select the Exit symbol and press button C.

SWITCHING THE LOW BATTERY ALARM ON AND OFF

Select the battery from the above menu and press Pushbutton C. This calls up the low battery alarm menu on which the user can set the low battery alarm options. The low battery alarm options are shown below.

Low Battery Alarm Off

Selecting this option and pressing button C will disable the low battery alarm completely.



Low Battery Alarm On1

Selecting this option and pressing button C will enable the low battery alarm setting to alert the user when the batteries need recharging or replacing.



Low Battery Alarm On2

Selecting this option and pressing button C will enable the low battery alarm setting to alert the user when the batteries reach the threshold set by the user.



Low Battery Alarm Threshold

Selecting this option and pressing button C will select the low battery threshold at which the low battery alarm will activate.



Low Battery Threshold Setup

Moving the slider with the left and right scroll buttons allows the low battery alarm threshold to be set. When the battery level reaches the threshold set the low battery alarm will activate. Press button C to confirm the setting and exit back to the low battery menu.

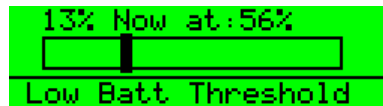

When the low battery alarm is set use the scroll buttons to select the Exit symbol and press button C.

SWITCHING THE LOW SIGNAL STRENGTH ALARM ON AND OFF

Select the transmitted signal icon from the above menu and press Pushbutton C. This calls up menu on which the user can select low signal alarm On or Off.



When the low signal alarm is set use the scroll buttons to select the Exit symbol and press button C.

THE VIBRA CALL ALERT MENU

This is the menu for determining whether the low battery and/or low signal strength warnings should use the vibrate function (type II backpacks only) and/or an audio beep function.

This menu is reached by selecting the Alarm option on the main programming menu then selecting the Vibrate/audio option. The alert

options are vibrate only, audio beep only, or vibrate and audio beep selected by pressing button C to step through the options.



When the required option is selected use the scroll buttons to select another menu item.

To return to the main programming menu, select Exit (the Up arrow on the display) and press pushbutton C.

THE HEADPHONE MENU

This menu is reached by selecting the Settings option on the top level programming menu, then the headphone options on the audio menu.



- The Headphones menu showing the option to set the lowest level to which the headset can be adjusted (sometimes also known as the "Gate Level").



- Press button C to select the Headphone Off menu and use the scroll buttons to select one of the settings.



- Press button C to select the setting, then use the scroll buttons to select Exit and press button C to return to the previous menu.
- The Headphones menu showing Sidetone level selected.



- Press button C to select Sidetone level and use the scroll buttons to set the Sidetone level on the slider then press button C to return to the previous menu.

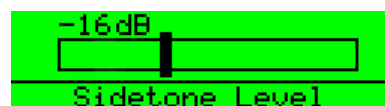

- The Headphones menu showing the default Normal Loudness setting selected.



In normal mode the noise levels are set to the same levels as in release 1.5.7, with Bass and Treble set to 0dB. Press button C to switch to the 'LOUD' mode.



In 'LOUD' mode the noise levels can be 10dB higher than in release 1.5.7 as the volume can be higher. The Bass level is reduced for clarity in a noisy environment and set at -12dB. The Treble level is increased for clarity in a noisy environment and set at +12dB.

Warning: The loud setting also turns off the headset limiter as indicated on the menu.

Press button C again to switch the Custom setting. This setting allows the bass and treble levels to be set by the user and has a maximum level 10dB greater than that in release 1.5.7.



Use the scroll buttons to select 'BASS' to set the Bass level.



Press button C to display the bass level setting and use the scroll buttons to adjust the level. Reducing the bass level will reduce any background busing noise.

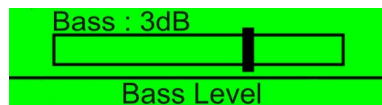

When the required bass level is set press the C button to return to headphone menu.

Use the scroll buttons to select 'TREB' to set the Treble level.



Press button C to display the treble level setting and use the scroll buttons to adjust the level. Reducing the treble level will reduce the background noise.

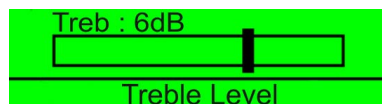

When the required treble level is set press the C button to return to headphone menu.

- The Headphones menu showing the Headset Limiter threshold option selected.



- This facility allows the user to make a local setting of the maximum signal level which is permitted to reach the headphone. The available levels are -6 to +16 dBu in 1 dBu steps. Use the scroll

buttons to set the Headphone Limiter level on the slider then press button C to return to the previous menu.

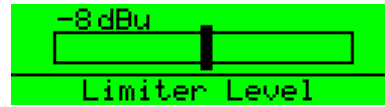

HEADSET NOISE GATE

To avoid the fluctuation in the headset noise gate it now operates as follows:

- Turns on - upon first detecting audio to the headset audio.
- Turned off - when receiving the loudspeaker off message from the basestation. The basestation sends this message when it is no longer routing audio to the beltpack.

THE MICROPHONE MENU

From the main programming menu select Settings and then Microphone Options to display the Microphones menu.



- The Microphones menu will be displayed.



- Select Microphone Type using the scroll buttons to display the Microphone Type menu.



- Use the scroll buttons to select the microphone type from those available (Dynamic (Bal) mic, Dynamic (UnBal) mic, Electret mic) and then press button C to set the microphone type. Use the scroll button to select the Exit symbol and press button C to return to the main Microphone menu
- The Microphone menu showing the microphone level option selected.



- This facility allows the user to select a level of microphone gain and so control the sensitivity of the microphone in the headset. Use the left and right scroll buttons to set the microphone level by moving the slider. The level can be set from 20dB to 65dB in steps of 5dB.



- Press button C to select the level setting and return to the previous menu or use the scroll buttons to select Exit and press button C to exit.
- The Microphone menu showing the Noisegate level option selected.



- This facility allows the user to select a level at which the audio is gated to prevent background noise being transmitted. Use the left and right scroll buttons to set the microphone level by moving the slider. The level can be set from 0 (off) to 14 in steps of 1.



- Press button C to select the level setting and return to the previous menu or use the scroll buttons to select Exit and press button C to exit.

Release 2.0.2 includes a mic profile which cuts the bass by 12 dB and boosts the treble by + 3 dB. This is permanently set for all modes.

The MklI beltpacks include a hardware mic gate and in release 2.0.2 this has been activated on Mic noise gate level 1 to allow a very low whisper on the beltpacks.

THE STATUS (INFORMATION) MENU

This function appears after the user has selected the Information symbol from the main programming menu.

- The Status (Information) menu showing the Role Information icon selected. Note that this face icon is used in two different menus. It

appears in the Talk/Listen menu to denote the Talk and Listen mode and it is used here, in the Status submenu to denote Role Information.



When this icon is selected the display appears showing the Role name and the Role number which represents it.



- The Status (Information) menu showing the Beltpack version number icon highlighted.



- When this icon is selected the display appears.

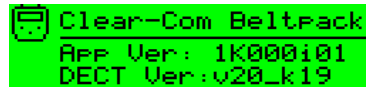

- The Status (Information) menu showing the Beltpack ID icon highlighted.



When this icon is selected the display appears. IPEI stands for International Portable Equipment Identifier, EMC for Equipment Manufacturer Code, PSN for Portable Serial Number (unique to every Beltpack) and C for check-digit.

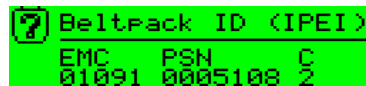

- The Status (Information) menu showing the Beltpack RF Carrier icon highlighted.



When this icon is selected the display appears showing the RF carrier mask in hexadecimal format. This mask is unique to the allowed DECT band in the country of use. It is set to a default European mask. Please see the Product manual for changing this.

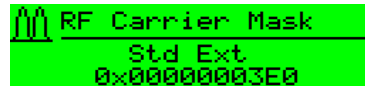

- The Status (Information) menu showing the Connection Information icon highlighted.



When this icon is selected the display appears. The components of this display are laid out in the format which is specified for this technology and appear as follows:

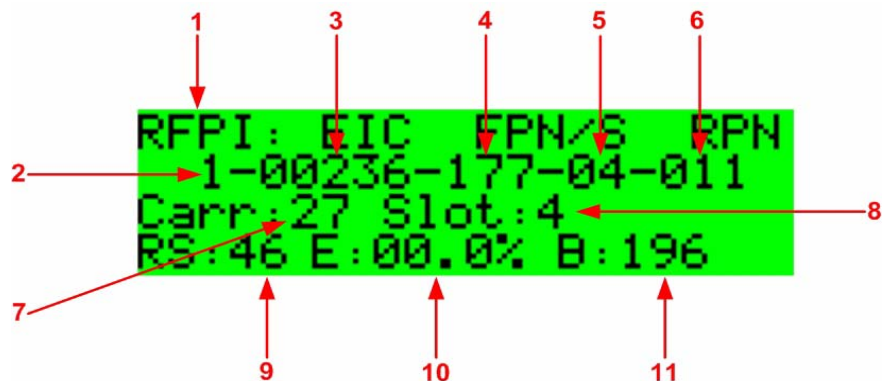

Figure 7-1: Connection Information Display

Table 7-1: Connection Information

Item	Description
1	Radio Fixed Part Identifier. This title refers to the whole of the second line of text. The RFP is the Radio Fixed Part to which the Beltpack is currently connected. (Much of this line of text is not unique to one Active Antenna.)

Table 7-1: Connection Information

Item	Description
2	This is the PARK (Primary Access Rights Key) number (reserved for future use.)
3	The abbreviation stands for Equipment Installer Code and the number on the second line is the EIC number.
4	Fixed Part Number. This and item 6 below are unique to the particular Active Antenna.
5	Fixed Part Sub-Number. This is effectively the system number which identifies which matrix the Beltpack is registered with.
6	Radio Fixed Part Number. This is the identifier of the Active Antenna on the system.
7	Carrier Number (both Active Antenna and Beltpack)
8	Timeslot Number (used by Active Antenna)
9	Received Signal strength Indication (digital indication). This is an arbitrary number in the range 0-52 and, therefore, significant only in the context of a particular installation.
10	Block error rate for received frames.
11	Raw battery level indication.

From these displays, press button C to return to the status menu.

ADJUST CONTRAST

- Select the Adjust Contrast option from the main programming menu and press button C to display the contrast setup.



- The contrast adjustment slider is displayed.

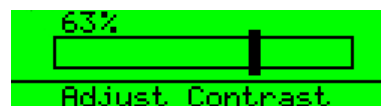

- Use the scroll buttons to adjust the contrast level and press button C to set the contrast and exit to the previous menu.

SET FACTORY DEFAULTS

To reset the beltpack to the factory defaults go to the main programming menu and select Set Factory Defaults.



The factory defaults options are NO to cancel the operation or YES to default all the user settable parameters such as limiters and levels to the factory settings.

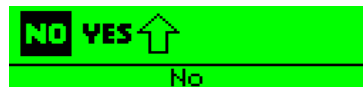

Select NO to cancel or use the scroll buttons to select YES to reset.



When the beltpack is reset to factory defaults and confirmation message is displayed.

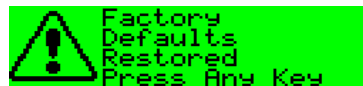

Press any key to return to the main menu.

TAP LATCH

The Tap Latch function determines whether the rotary push buttons latch with one tap or two taps when the beltpack is set in latching mode.

- Select the Button Options menu from the Programming menu.



- Select the Tap Latch on the Button options menu and use the scroll keys to toggle between the 1 Tap Latch and 2 Tap Latch states.



- Press button C to set the Tap Latch mode.

KEYLOCK

Keylock allows the scroll buttons to be disabled when on the main page after 3 seconds of inactivity to prevent accidental activation.

- Select Button options on the programming menu.



- Select keylock on the button options menu and use the scroll buttons to select Keylock On or Keylock Off.



- Press button C to set the keylock mode. If keylock is on a symbol will be displayed on the main pages showing that the keys are locked. To temporarily disengage keylock press and hold the scroll keys simultaneously for 3 seconds. A short beep in the headphones will signal that the keylock has been disengaged.

PTT CONFIGURATION

PTT configuration allows a PTT switch to be enabled or disabled.

Note: These features are only available on PD2202 beltpacks.

- To configure PTT set to the Button options menu and use the scroll keys to select PTT configuration.



- The PTT configuration menu will be displayed. Use the scroll buttons to enable or disabled the PTT switch.



Use button C to set the PTT switch status.

MASTER VOLUME CONTROL

The master volume control is set from the main menu.

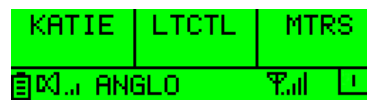

Press and hold both scroll buttons until the main menu is displayed.



Select the Master Level and adjust the slider using the left/right scroll buttons until the required volume is obtained.

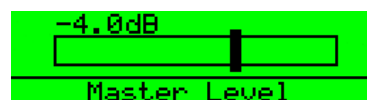

Press the centre button to exit the master level and use the scroll buttons to exit the main menu back to the display page.

PAGE OPTIONS

The Page Options on the main menu give access to the page lock and key options menus.

PAGE LOCKING

When you are looking at a normal display you are looking at one of up to six numbered pages with three key assignments on each. Eclipse supports up to eighteen key assignments. The page icon indicates the page number of the current page. The setting of page number is global to the system and only one page can be current at a time.

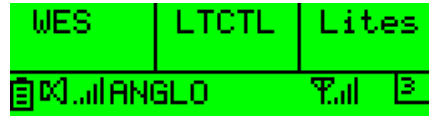

The significance of upper and lower case text on the display is explained in the Operational Information.

To display a different page, change to menu mode and select Page Options. This will display the page options menu.



Use button C to change the page status from page change allowed to page locked to prevent the page being changed.



8

OPERATING THE FREESPEAK TRANSCEIVER/ANTE NNA

TRANSCEIVER/ANTENNA (FS-TA)

The FreeSpeak transceiver/antennas (FS-TA) form the transmission link between the FreeSpeak beltpacks and the FreeSpeak basestation. Multiple units are used to support the beltpacks and to create larger, customized coverage areas. Each FS-TA is connected to the FreeSpeak basestation, either directly or via a PD2203 splitter. The unit has two flanges on the rear side that permit the unit to be screwed or otherwise attached to surfaces.



Figure 8-1: FreeSpeak Transceiver/Antenna

FS-TA TOP PANEL

Omnidirectional Antennas

A pair of omnidirectional antennas are provided with the transceiver/antenna.

Antennas with different coverage patterns (directional units) that are appropriate for the 1.9 GHz range may be substituted for the provided antennas, if variations in coverage pattern are required.

FS-TA BOTTOM/CONTROL PANEL

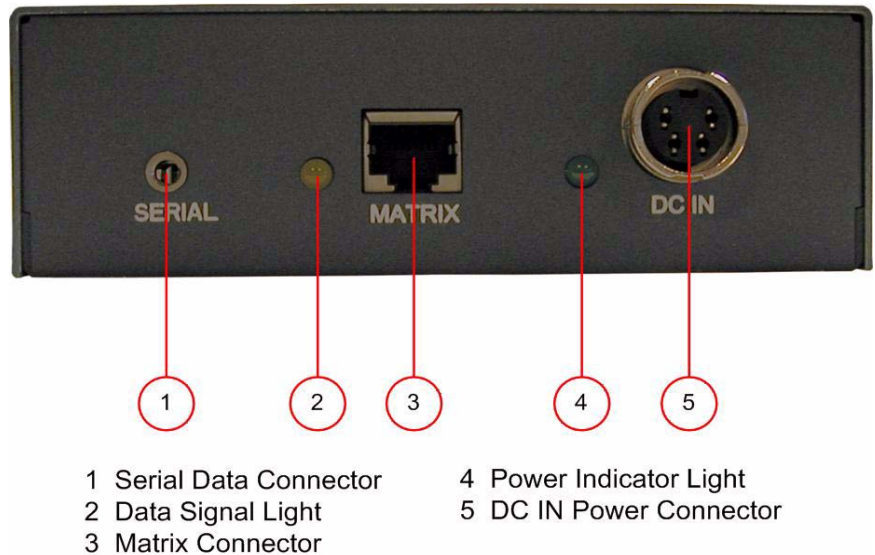

Figure 8-2: FreeSpeak Transceiver/Antenna Bottom/Control Panel

① Serial Data Connector

This 3 mm (1/8 inch) tip-ring-sleeve (TRS) connector is used for upgrading the firmware in the FS-TA. It will typically be unused.

② Data Signal LED

This amber LED indicates that a connection has been established between the FreeSpeak basestation and the transceiver/antenna, and that it is actively creating a coverage zone within which the belt packs can operate. If it is off, check the cable connections at both ends, as well as the powering.

When viewing an antenna status directly at the antenna, the amber LED indicates that it is receiving a data link from the basestation, however this does not guarantee that the basestation can receive data messages from the antenna.

③ Matrix Connector

This RJ-45 connector is used to connect the bi-directional signal from the FreeSpeak basestation, directly or via the splitter. Up to 1,000 metres (3,200 feet) of 4-pair 24AWG CAT-5 cable can be used for this

connection between basestation and transceiver/antenna. If 26AWG CAT5 cable is used the maximum distance is 500 metres (1,600 feet).

④ Power LED

This green LED indicates that the transceiver/antenna is receiving power, either from its local power supply or from the connected CAT-5 cable (distances up to 300 meters, or 925 feet, from the basestation or the splitter) being powered via the FreeSpeak basestation.

⑤ DC In Power Connector

This connector is used to locally power the transceiver/antenna with the supplied universal power supply. Use of local power is required when the transceiver/antenna is located more than 300 meters (925 feet) from the FreeSpeak basestation or the splitter, and is recommended even when the transceiver/antenna is closer whenever it is available and convenient.

CABLING THE FS-TA TRANSCEIVER/ANTENNAS

Each FreeSpeak transceiver/antenna receives its necessary data and digital communications audio via a direct connection with the basestation transceiver ports. Between these two ports, up to 10 transceiver/antennas can be supported. A transceiver/antenna may either be directly connected to a basestation port using 4-pair CAT-5 data cable with RJ-45 connectors on each end, or it may be connected to the basestation through an antenna splitter.

BELTPACK SUPPORT CAPACITIES FOR TRANSCEIVER/ANTENNAS

Each transceiver/antenna can support five belt packs within one coverage zone. With the supplied omnidirectional antennas, the coverage pattern is circular or donut-shaped, with a maximum range of up to 250 meters (800 feet), but with typical range between 50 meters and 150 meters – depending on the environment in which it is installed.

When designing the system, determine how many belt pack users will be in or passing through a given coverage zone. If it will be five or fewer users, then place one transceiver/antenna in the center of that area. If it is between 6 and 10 users, place two transceiver/antennas next to each other, both with a direct connection to the FreeSpeak basestation or splitter. In larger systems – approaching 20 belt packs – it is wiser to allow one transceiver/antenna for every 3 to 4 users to ensure smooth handoffs between transceiver/antennas. It is good practice to have each belt pack “seeing” two or more antennas, so a minimum of two antennas in any system is to be considered.

If a sixth beltpack user goes into a coverage zone with only one transceiver/antenna, and that user is out of range from another transceiver/antenna in the overall system to which that beltpack is currently connected, it will lose connection with the system. This is because the transceiver/antenna has a maximum capacity of five beltpacks at a time. If one of the existing users in that coverage area turns off a beltpack or leaves the area, then the sixth beltpack will find an open slot and will be reconnected with the system.

The proprietary technology within FreeSpeak permits the beltpack user to go between coverage zones created by different transceiver/antennas connected to the FreeSpeak basestation, and for the system to hand over the communication between beltpack and basestation from one transceiver/antenna to the next one. Thus, a larger, customizable communications area may be designed.

COVERAGE AREAS UNDER VARIOUS CONDITIONS

Just as with any other product communicating via radio waves, the effective distance between the beltpack and the transceiver/antenna (the range) will differ depending on the particular environment in which it is being used. Radio waves can be attenuated by walls, floors, ceilings, trees, shrubbery, the human body (such as an audience), and numerous other objects. They can be reflected and/or stopped by metallic objects such as structural beams, safety doors, lighting equipment and truss, bodies of water, and so on.

Under ideal conditions, the maximum range between a FreeSpeak beltpack and a transceiver/antenna is 250 meters (about 800 feet). Typical distances are between approximately 50 meters (about 160 feet) and 150 meters (about 485 feet), depending on the particular environment.

As the transceiver/antenna requirements for a particular installation are being determined, keep in mind both the number of beltpack users who will be working in a particular area (based on the five-beltpack capacity of each transceiver/antenna), and the layout and potential RF attenuating and reflecting items in the location. Be conservative in distance estimates to make sure that enough transceiver/antennas are included to provide the necessary coverage for the installation. Also note that additional transceiver/antennas may be added to a basestation, up to a maximum of 10.

TRANSCIVER/ANTENNA SETUP RULES AND TIPS

Keep the following general rules and tips in mind:

- Keep antennas high (typically, though lower placements away from interfering objects can at times be beneficial) and line-of-sight.
- Keep them away from larger metallic objects and surfaces, and from lighting truss.

- With the provided omnidirectional antennas, the coverage is circular so put the transceiver/antennas in the center of the area in which coverage is required.
- In outdoor settings with line-of-sight, the absence of beneficial reflections of the radio waves may lead to shorter than expected range; directional antennas may be of benefit here.
- When overlapping the coverage zones of transceiver/antennas to create larger continuous coverage areas, test the in-between areas with a belt-pack for potential areas of low RF signal; adjust the positioning of the antennas as needed.
- Because of potential body shielding as the user moves, it will be useful to place two transceiver/antennas in different locations within larger working areas to minimize low-level signals and potential signal dropouts.
- Going between a larger area and a corridor via a door, especially a heavy or shielded one, or where the walls are thick, place a second antenna in the corridor near the doorway to assure continuous coverage.

TRANSCIVER/ANTENNA SPLITTER (PD2203)

The PD2203 antenna splitter is the device that connects multiple transceiver/antennas to the FreeSpeak basestation. It has an RJ-45 connector that carries the data between a basestation transceiver port and the splitter, and five RJ-45 connectors to feed that information to and from up to five antennas. The splitter is always locally powered via the supplied external in-line universal power supply.

PD2203 FRONT CONNECTOR PANEL

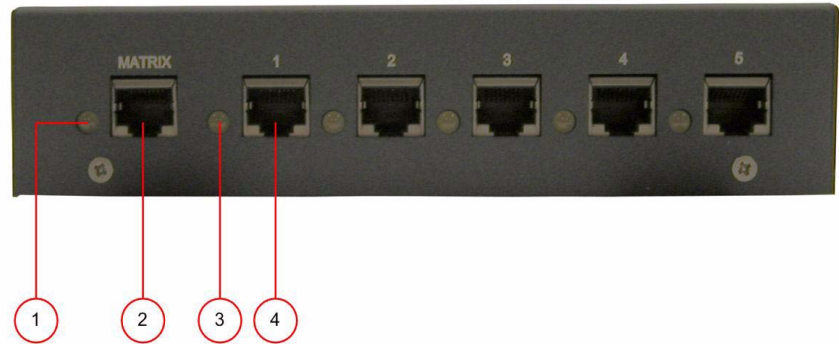

- 1 Base Connection Indicator Light
- 2 Matrix (Base Station) Connector
- 3 Splitter-to-Transceiver/Signal Indicator Lights (5)
- 4 Transceiver/Antenna Connectors (5)

Figure 8-3: FreeSpeak Splitter Front Connector Panel

① Basestation Connection Indicator Light

This yellow light indicates that the PD2203 splitter is receiving data from the FreeSpeak basestation.

② Matrix (FreeSpeak Basestation) Connector

This RJ-45 connector accepts a 4-pair data cable from the FreeSpeak basestation transceiver port. This cable can be up to 1,000 metres (3,200 feet) in length if 24AWG cable is used or up to 500 metres (1,600 feet) if 26AWG cable is used.

Note: It is recommended that shielded CAT-5 cable is used.

③ Splitter-to-Transceiver/Antenna Signal Indicator Light

These yellow lights indicate that a connection from the FreeSpeak basestation is available to the particular transceiver connected to that port.

④ Transceiver/Antenna Connectors

These five RJ-45 connectors are used to connect up to five remote transceiver/antennas to the splitter, and via the splitter to the FreeSpeak basestation. Each of these cables can be up to 1,000 metres (3,200 feet) in length if 24AWG cable is used or up to 500 metres (1,600 feet) long if 26AWG cable is used.

PD2203 REAR PANEL

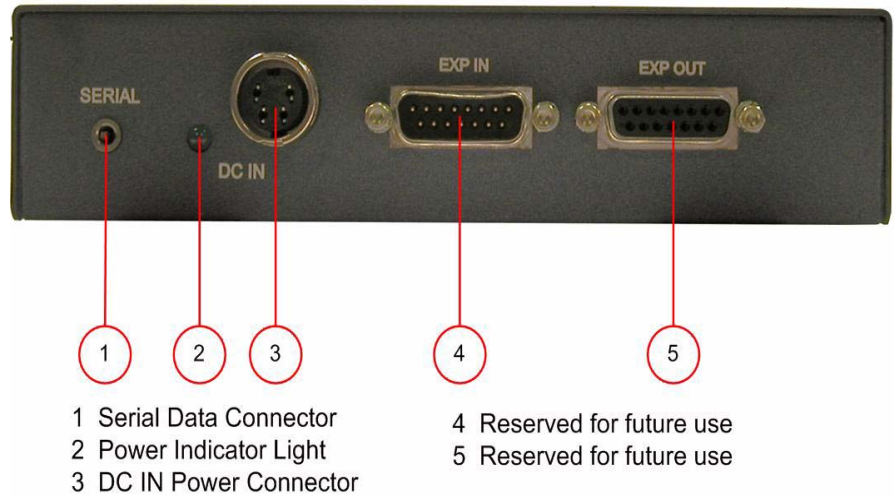

Figure 8-4: FreeSpeak Splitter Rear Connector Panel

① Serial Data Connector

This 3.5 mm (1/8 inch) tip-ring-sleeve (TRS) connector is used for upgrading the firmware in the PD2203. It will typically be unused.

② Power Indicator

This green LED indicates that the splitter is receiving power from the external power supply.

③ DC IN Power Connector

This connector is used to locally power the antenna splitter with the supplied universal power supply. Use of local power is required.

④ EXP IN Connector

This male DB-15 connector is reserved for future use.

⑤ EXP OUT Connector

This female DB-15 connector is reserved for future use.

CONNECTING AN ANTENNA SPLITTER TO THE FREESPEAK BASESTATION AND TO TRANSCIVER/ANTENNAS

After the connections have been made between the splitter and the transceiver/antennas, make sure that the data LED's are lit at the individual ports on the antenna splitter. Also make sure that the both the green power LED and the yellow data LED are lit on each FS-TA transceiver/antenna. If all are properly lit, then the connection has been successfully made and the coverage zones will be active and will support belt packs. If the transceiver antennas are not lit, check the connections.

9

INSTALLING A SYSTEM

The user can begin using a FreeSpeak system as soon as it is received as long as the beltacks are registered to the basestation, using the generic user labels for the beltacks and the rear-panel connections.

PLACING THE BASESTATION

The first stage in setup is placing the basestation in a convenient location, knowing that it is the central routing unit of the FreeSpeak system. It should be made accessible.

A FreeSpeak system can work immediately when it is received, as long as the beltacks are registered to the basestation.

At this stage, if they are unregistered, the user may want to register all of the beltacks with the basestation, or at least register one or two for system setup and testing. Follow the instructions in the chapter “FreeSpeak Configuration Editor” to register the beltacks.

PLACING THE ANTENNAS AND SPLITTERS

The next step is to begin placing antennas and splitters to provide the necessary coverage areas for all of the beltacks. The first placements of antennas and splitters will be experimental and temporary. After placing the antennas, walk through the coverage areas to check for gaps and then re-locate the antennas accordingly.

More information on checking coverage areas is given later in this chapter, in the sections “Determining Coverage Areas” and “Doing a Site Survey to Determine Coverage Areas.”

The following questions will help to begin placing the antennas:

- What areas will have more than five active beltack users in them at any time? Co-locate a second FS-TA there.
- Is there a central place to locate an antenna so that it will provide omnidirectional (all directions / circular) coverage?
- Are there balcony areas, corridors, or other rooms or areas that will require coverage with antennas?

Next decide where the antenna splitter(s) that feed these antennas will be safely located. For systems with only one or two transceiver/antennas, the cable runs will go directly from the two transceiver ports on the basestation.

Note: To meet FCC emissions requirements a ferrite must be fitted on any CAT-5 cable plugged into either of the two ports labeled “tranceivers.” The ferrite should be fitted at the basestation end of the CAT-5 cable. Position the ferrite as close to the basestation as possible.

The manufacturer of the ferrite is Wurth Elektronik. The part number is 742 711 32.

WIRING THE ANTENNAS AND SPLITTERS

To wire antennas and splitters:

1. Run 4-pair CAT-5 cable from the FreeSpeak basestation to the antenna or splitter, and determine that the antenna or splitter is showing both power (green LED lit) and signal (yellow LED lit when the basestation is on).

Note: To meet FCC emissions requirements, a ferrite must be fitted on any CAT-5 cable plugged into either of the two ports labeled “tranceivers.” The ferrite should be fitted at the basestation end of the CAT-5 cable. Position the ferrite as close to the basestation as possible. The manufacturer of the ferrite is Wurth Elektronik. The part number is 742 711 32.

Note: It is recommended that shielded CAT-5 cable is used.

2. Run 4-pair CAT-5 cable from the splitter to each of the transceiver/antennas.
3. Make sure that the local power supplies are plugged into the antennas, unless they are close enough to the basestation to draw power from the attached CAT-5 cable.

The indication that a transceiver/antenna has sufficient power from the cable is if the green power LED and the yellow data LED light up. If there are several longer runs and are attempting to power the transceiver/antennas from the basestation / splitter connection, check each one again when they are all connected. The local powering for the FS-TA is recommended in most cases to provide the most reliable long-term FreeSpeak installation.

Note that 4-pair CAT-5 cable with RJ-45 connectors on each end is specified for connection between the basestation and the transceiver/antennas. Use of other cable can result in markedly shorter distances of cable runs and other possibly other performance problems.

During the initial system setup, before walking through the system with a backpack to check for gaps in coverage, it is wise to avoid “permanently” installing the transceiver/antennas. Hold them in place in some temporary way until their optimal position is determined.

DETERMINING COVERAGE AREAS

After the transceiver/antennas and splitters have been initially set up proceed to test the coverage areas and re-locate antennas and splitters, if necessary, for optimal coverage.

To determine coverage areas:

1. Once the basestation, splitter(s), and transceiver/antennas have been placed and wired, turn on a FreeSpeak backpack (assuming

that it has been registered with the basestation) and walk the coverage area – ideally speaking with someone else via the on-basestation headset or a party-line or matrix connection with the basestation.

Alternatively, use the “site survey” mode on the beltpack (see “Doing a Site Survey to Determine Coverage Areas” below). It is often best to begin with one antenna in place, and then place additional units to enhance coverage.

2. Walk through all of the areas where beltpack users will typically be moving, and note any areas of weak signal, dropout, or disconnection from the system. Pay special attention to the overlap areas between antenna coverage zones, making sure sufficient signal strength is there from each of the transceiver/antennas to make a clean handoff between them for the beltpack.
3. Finally, when the coverage zones have been properly and effectively set up, it is time to program the system. See Chapter 5, “Programming a System from the Basestation” for instructions.

DOING A SITE SURVEY TO DETERMINE COVERAGE AREAS

Some FreeSpeak users may want to test coverage areas more extensively before setting up a complete system. Testing a system in the setting in which it will be located helps to set up the system successfully to meet operational needs. Factors in the local setting may affect the areas a system can cover, so it is important to plan a site setup accordingly.

Doing a complete site survey, as described below, helps to set up an optimal system.

TESTING COVERAGE AREAS OF INDIVIDUAL ANTENNAS

1. Place the FreeSpeak basestation in a convenient location. Register one beltpack to the basestation.
2. Place one antenna in the center of the coverage area.
3. Put the beltpack into “site survey mode” by first pressing the power button on the back of the beltpack, and then simultaneously pressing the two front-panel scroll buttons.
 - When this is done the beltpack’s display shows the “site survey” screen. Figure 9-1 shows a beltpack’s site survey screen.
 - A beltpack can also put a beltpack into “site survey mode” after it has powered up by simultaneously holding down the two front-panel scroll buttons, and selecting first “View Status” and then “Connection Info” from the basestation’s front panel display.
4. Walk around the antenna with the beltpack, monitoring the beltpack’s *signal strength* and *error rate* at various distances.

The *signal strength* is shown in the Received Signal Strength Indication (RSSI) field in the leftmost lower corner of the beltpack's display. The *error rate* is shown in the ERR field in the middle of the display.

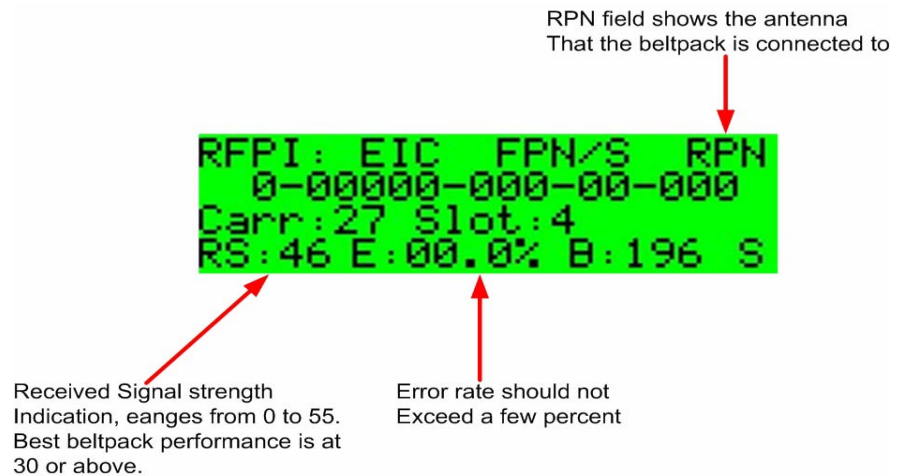

Figure 9-1: A Beltpack's Site Survey Screen

- The **RS** (signal strength) number will fluctuate, ranging from 0 to 55, as the user walks through the coverage area, and may even fluctuate as the user stands still. As a rule-of-thumb the best system performance will be obtained when the signal strength remains at 30 or above. If the signal strength falls below 30 the beltpack may start losing audio. This is the limit of the coverage zone.
- The **ERR** (error rate) number indicates packets of audio which are lost or corrupted. When this number exceeds a few percent the user may start hearing audible audio breakup.
- A high Received Signal strength indication and a high Error rate may indicate that there is another RF system causing interference.

A beltpack can transmit to an antenna outdoors at an average distance of 125 meters when the beltpack has an unobstructed "line-of-sight" path to the antenna. In ideal conditions, the range may be as high as 250 meters. Indoors, a beltpack can transmit to an antenna at an average distance of 50 meters.

5. Draw a map of the coverage zone for the antenna. The coverage zone is the area where the signal strength, as a rule-of-thumb, is 30 or above and the error rate is below a few percent.
6. Repeat this process, one antenna at a time, for as many antennas as necessary to cover the required area. Overlap coverage zones so that there is no area where the signal strength is below 30, and no area where the error rate is above a few percent.

7. The antenna placement will need to be adjusted to get the best coverage.

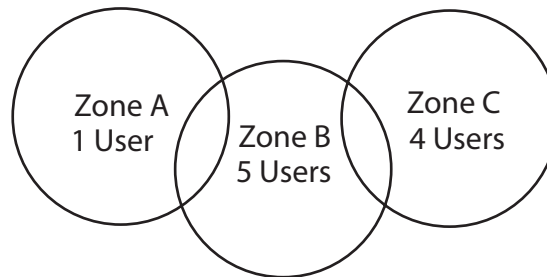

Figure 9-2: Mapping overlapping coverage zones

In some environments the user may observe that despite having a high signal strength, the beltpack consistently reports a high error rate.

This could be due to two things:

- In-band interference from an RF source broadcasting in the DECT area of the spectrum. This can be verified using a DECT band monitor or by using a Spectrum Analyser.
- Long Delay Spread Multipath, where the signal is bounced off a number of reflective surfaces, such as metal ceilings, gantries, walkways or other large structures. This problem is greatest where the reflective surface is large and exists at a range of distances from the antenna. To resolve this problem, consider siting the antenna where it cannot “see” the reflective surface, installing a reflector close to the antenna between it and the reflective surface, or purchasing directional antennas. Contact VGC customer support for more information.

TESTING ANTENNA HANDOFF

After testing the coverage areas for individual antennas, test the handoff between the antennas. When the user walks through a coverage area with the beltpack, the beltpack searches to find the antenna with the best signal strength, and switches transmission to that antenna. Therefore the beltpack continually hands off transmission among antennas as the user moves through the coverage area.

To test antenna handoff, connect any additional antennas in the installation and walk through the coverage areas to ensure that the coverage is continuous and complete, without audio breakups. The user can tell which antenna the beltpack transmits to by looking at the RPN number in the top rightmost corner of the beltpack’s display when the beltpack is in “site survey” mode. Reposition antennas if necessary. Note that the numbering to identify antennas starts at “6” to identify the first antenna, as shown in the table below.

BELTPACK SCREEN DISPLAYS:	WHICH SIGNIFIES:
RPN 6	Antenna 1 on transceiver port 1
RPN 7	Antenna 2 on transceiver port 1
RPN 8	Antenna 3 on transceiver port 1
RPN 9	Antenna 4 on transceiver port 1
RPN 10	Antenna 5 on transceiver port 1
RPN 11	Antenna 1 on transceiver port 2
RPN 12	Antenna 2 on transceiver port 2
RPN 13	Antenna 3 on transceiver port 2
RPN 14	Antenna 4 on transceiver port 2
RPN 15	Antenna 5 on transceiver port 2

Table 9-1: How antennas are numbered

GETTING INFORMATION ON ACTIVE ANTENNA STATUS

The user can also monitor which beltpacks are connected to which antennas using the basestation's SYSTEM menu.

When the user selects ANTNS from the SYSTEM menu, the display shows the status of the active antennas that are connected to the basestation, and shows the slots on each antenna that are occupied by beltpacks. This information may be useful during a site survey, or when troubleshooting coverage areas or antenna connections.

A typical display is shown below:

```

1> ___ ___ ___ ___ ___      6> 1 ___ ___ ___ ___      SYSTEM: 1
2> ___ ___ ___ ___ ___      7> 3 ___ ___ ___ ___      TOTAL ONLINE: 4
3> 2  4 ___ ___ ___ ___      8>
4>
5>
                                9>
                                10>

```

Figure 9-3: ANTNS menu

The numbers 1 through 10 represent the maximum number of antennas that can be connected to the basestation. Numbers 1 through 5 can be positions on a splitter connected to transceiver port 1, while 6 through 10 can be positions on a splitter connected to transceiver port 2. An antenna connected directly to transceiver port 2 would appear at position 6.

“___” indicates an empty slot on an active antenna that is connected to the basestation. A number in place of a “___” indicates that this slot is occupied by the indicated beltpack.

Blank spaces next to an antenna number indicate that no antenna has been detected in this position.

So the above display would indicate that five antennas are connected to the basestation in positions 1, 2, 3, 6, and 7. There are no active antennas in positions 4, 5, 8, 9, and 10.

There are 4 beltacks currently connected. Beltacks 2 and 4 occupy the first 2 slots of antenna 3; beltack 1 occupies the first slot of antenna 6; and beltack 3 occupies the first slot of antenna 7.

The display updates every 4 seconds to reflect changes in antenna status and beltack connections.

Rotate or push in the setup/enter knob to exit this menu.

ASSIGNING BELTPACKS TO COVERAGE AREAS

Each antenna is designed to handle five beltacks simultaneously. Although it can achieve this in good conditions, this may not always be possible for a number of reasons. First, interference or propagation problems may mean that not all antenna slots are available all the time. Second, a beltack constantly searches for the best antenna signal, and may frequently switch antennas. To make this transmission seamless, a beltack maintains the connection to its current antenna until it is confident that the new antenna is functioning well. Therefore, for a short period of time during this transition, a single beltack can occupy slots on more than one antenna.

This means that for zones likely to need coverage for five or more beltacks simultaneously it is recommended that a second antenna is installed. Similarly, for good coverage for nine or more beltacks simultaneously, a third antenna may be required.

CONDITIONS AFFECTING COVERAGE AREAS

The environment in which a system is located affects the coverage area for any particular beltack/antenna combination. The presence of walls, floors, ceilings, trees, shrubbery, people, and numerous other items may affect the coverage zone. Metallic objects, safety doors, lighting equipment, and bodies of water may possibly block transmission. These factors must be taken into consideration when planning the installation.

10 FREESPEAK CONFIGURATION EDITOR

INTRODUCTION

The Cellcom/Freespeak Configuration Editor can be used to extract, backup, edit and restore configurations from the Cellcom/Freespeak basestations. Configurations are initially extracted from a Cellcom/Freespeak basestation via the serial cable, and once extracted they can be edited and either sent back to the basestation or saved to disk for future use.

It can also be used to "clone" a basestation in case of systems failure - all belt-pack registrations and the system ID are stored within the config.

LOADING AND SAVING CONFIGURATIONS

On loading the configuration editor should display the initial screen:

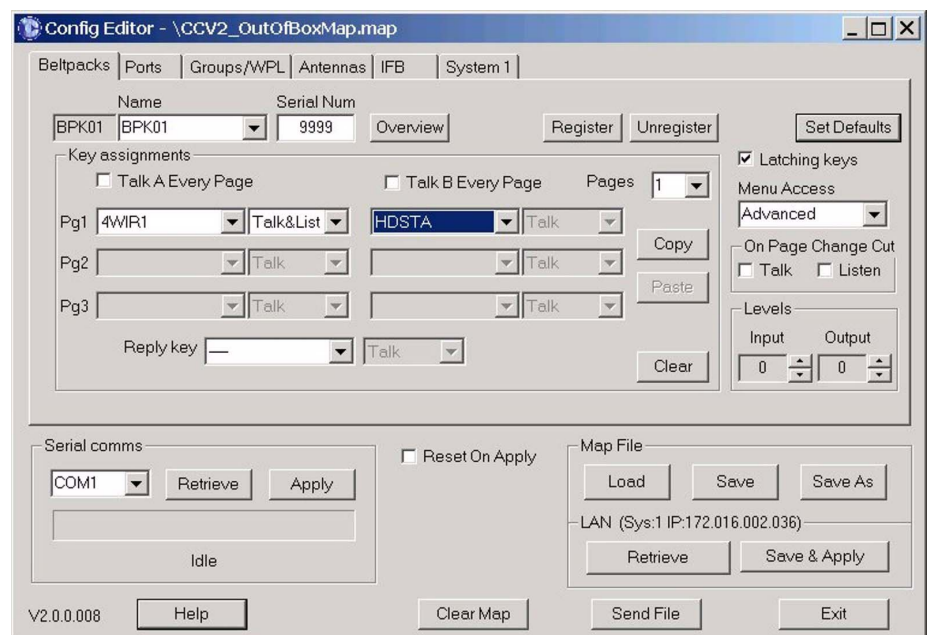

Figure 10-1: Configuration Editor Initial Screen

At this point the user has the choice of either loading a previously extracted configuration from disk, or extracting one from a Cellcom/Freespeak basestation.

LOADING A CONFIGURATION FROM DISK

To load a configuration from disk, click the 'Load' button. A dialog box will pop up, allowing the user to browse for the configuration file. Configuration files end in a ".map" extension.

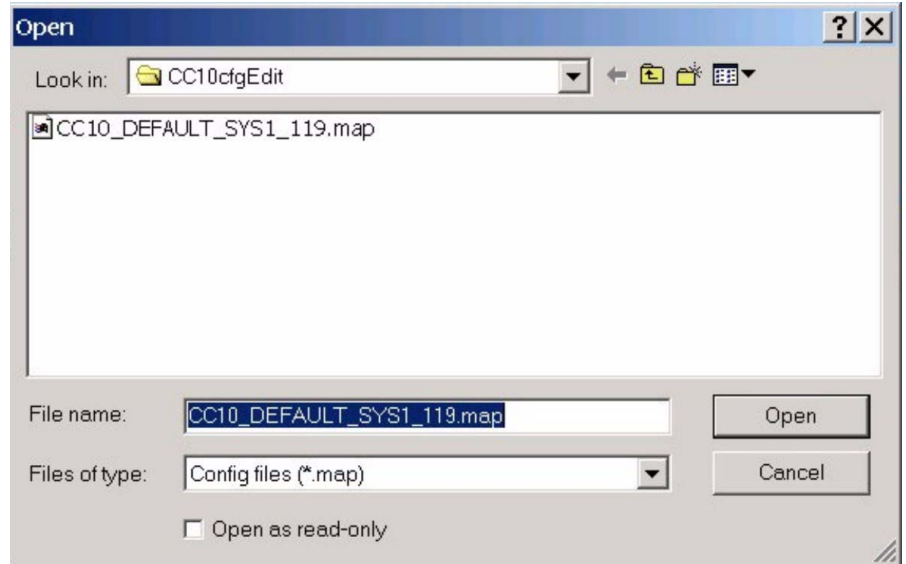

Figure 10-2: Map Select Screen

COM PORT SELECTION

The COM port drop-down box shows only those ports that are available for connection to the basestation. If the required port is not shown it may be that another program is using this port. Close the other program down, and try again.

IP SETUP

The basestation IP address can be set in the configuration editor under the 'System' tab and on the basestation via the 'System' menu. The procedure for setting the basestation IP address using the configuration editor is described in this chapter and the procedure for setting up the IP address on the basestation is described in chapter 5.

RETRIEVING A CONFIGURATION FROM A FREESPEAK BASESTATION VIA THE SERIAL LINK

- Connect the PC to the basestation using a standard Cellcom/Freespeak serial cable. Select the COM port that it is connected to using the drop-down box in the "Serial comms" section of the dialog. Power on the Cellcom/Freespeak basestation and wait 30 seconds.

- Click the 'Retrieve' button in the "Serial Comms" section of the dialog. Retrieval of the configuration should take around 1 min. 15 secs. If the program fails to connect to the Freespeak basestation, the following dialog will be displayed:



Figure 10-3: Configuration Editor Serial Timeout

- If this occurs, check the cable, PC and basestation connection, and also make sure that 30 seconds have elapsed since powering on the basestation to ensure that serial comms have been activated.
- Once the configuration has been retrieved from the basestation, the display should appear as follows:

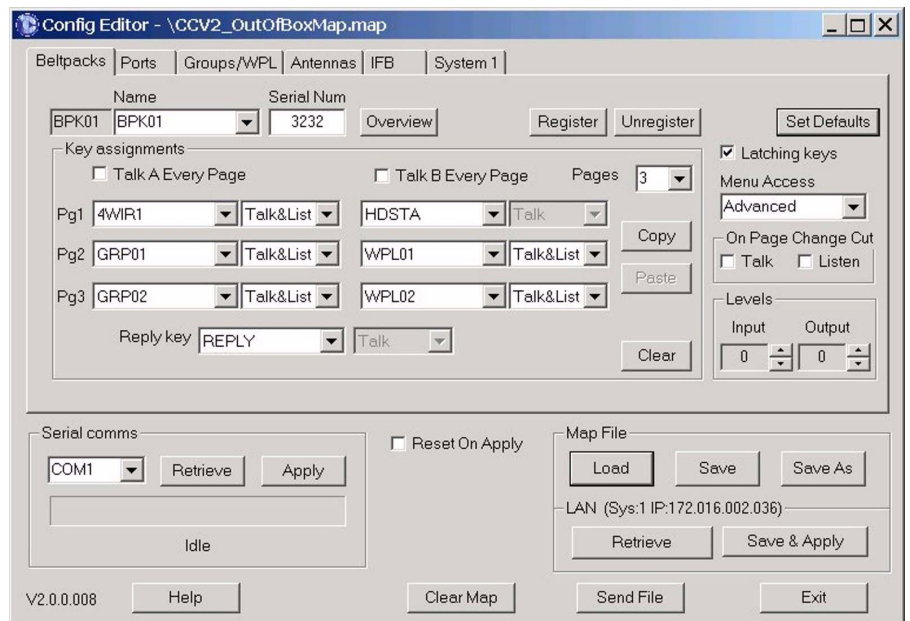

Figure 10-4: Configuration Setup

RETRIEVING A CONFIGURATION FROM A FREESPEAK BASESTATION VIA ETHERNET

- Connect the PC and the basestation to the local network and set up an IP address on the basestation.
- Click the 'Retrieve' button in the "LAN" section of the dialog. A progress window will be displayed showing the upload.

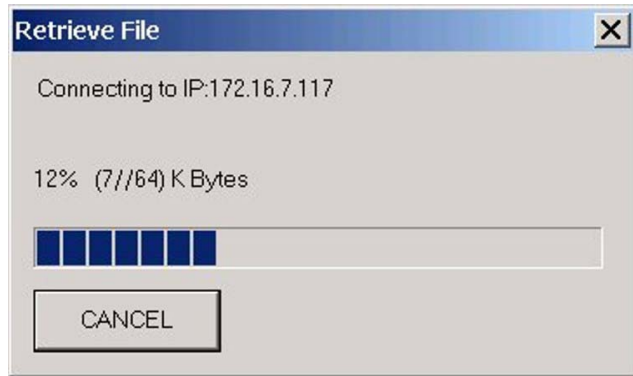

Figure 10-5: Map Upload Progress

- Retrieval of the configuration should take around 15 secs. If the program fails to connect to the Freespeak basestation, the following dialog will be displayed:



Figure 10-6: Configuration Editor Ethernet Timeout

- If this occurs, check the ethernet connections at the PC and the basestation. Ensure that the IP address is correct and that it is valid for use on the local network.
- Once the configuration has been retrieved from the basestation, the display should appear as follows:

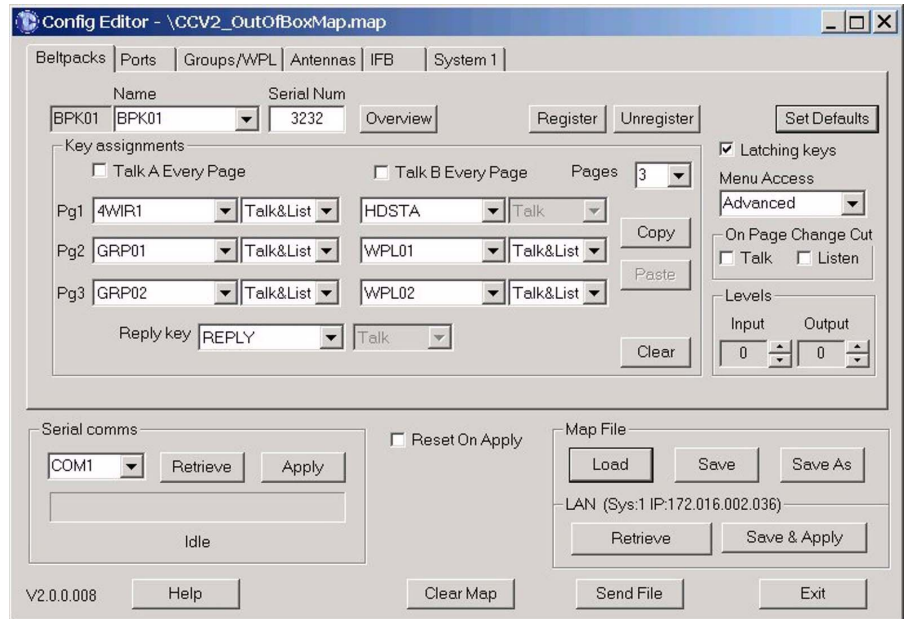

Figure 10-7: Configuration Setup

The four buttons at the bottom of the Configuration Editor screen provide the following functions.

Help

Opens the online help for the Configuration Editor.

Clear Map

Clears the current map from the Configuration Editor buffer. All the parameters set in the editor will be reset to the startup defaults.

Send File

Sends a firmware file (normally a 4kr file) to the basestation. This is normally only used to update the basestation firmware.

Exit

Exits the Configuration Editor. If a map has been changed or retrieved from the basestation and not saved the user will be offered the option to save the map before exiting the editor.

UPLOADING CONFIGURATIONS USING THE SERIAL LINK

To send an edited configuration back to the basestation using the serial link, re-connect the basestation (if it has been disconnected) and ensure that at least 30 seconds have elapsed since basestation power-up to allow serial comms to be activated, then click the 'Apply' button in the 'Serial comms' area. Transfer should take around 1 min. 15 secs. If it is required that the basestation is reset after the the map is uploaded the 'Reset On-Apply' checkbox should be checked. If this is the done the basestation will reboot and the levels will be reset to the default levels If a reset is not requested the map will be applied but the levels will not be reset to the defaults.

UPLOADING CONFIGURATIONS USING ETHERNET

To send an edited configuration back to the basestation ensure that there is an ethernet link and click the 'Save &Apply' button in the 'LAN' area. Transfer should normally take a few seconds. If it is required that the basestation is reset after the the map is uploaded the 'Reset On-Apply' checkbox should be checked. If this is the done the basestation will reboot and the levels will be reset to the default levels If a reset is not requested the map will be applied but the levels will not be reset to the defaults.

BELTPACKS TAB

This tab allows the user to register beltpacks with the basestation, edit key assignments and change input and output levels.

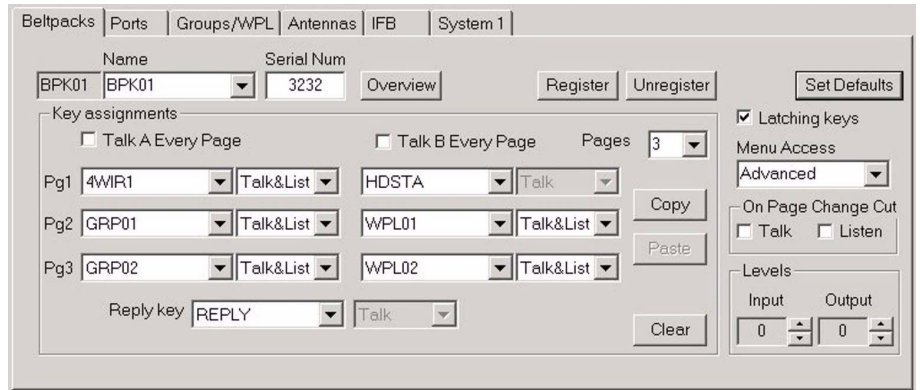

Figure 10-8: Beltpacks Tab

SELECTING THE BELTPACK TO REGISTER OR EDIT

Select which of the twenty available beltpack "slots" is to be edited using the down arrow next to the beltpack name field. This will open a drop-down menu containing all twenty beltpacks with serial numbers.

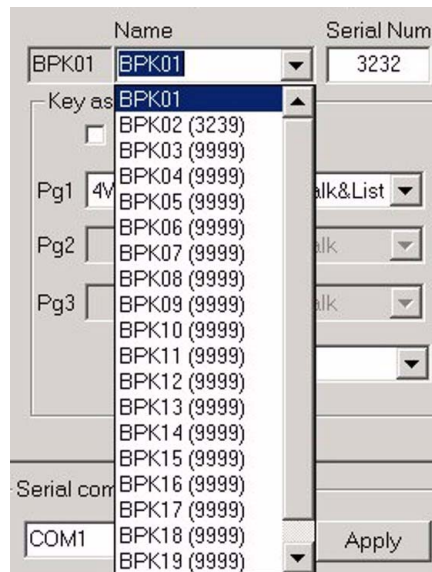

Figure 10-9: Beltpack List

Select the beltpack to be changed, then over-type the text in the 'Name' box (shown with a white background in the illustration below). A maximum of five characters can be entered.

Enter the serial number of the beltpack in the 'Serial Num' box next to the 'Name' box by overtyping the current number (normally the default

of 9999). The beltpack serial number is a four digit number on a label on the back of the beltpack.

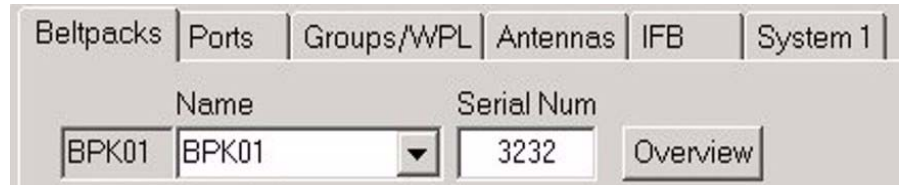

Figure 10-10: Beltpack Label

REGISTERING BELTPACKS USING THE SERIAL LINK

When beltpacks are first registered with a basestation they must be "paired" with the basestation using the procedure below. Once paired with the basestation the beltpacks can be edited using the configuration editor or the basestation front panel menus.

- First load or retrieve a configuration as described in the "Getting started" section.
- Connect the beltpack to the PC using the standard Beltpack serial cable (3.5mm stereo jack to 9 way D type connector), and power it on.
- Select the serial port connected to the beltpack by using the drop-down box in the "Serial comms" section of the dialog box. (Note that if there are 2 serial ports on the PC, one can be used to be program the basestations while the other can be used to program beltpacks).
- Select the "Slot" to register the new beltpack in (i.e. one of slots 1 to 20) using the arrow button next to the beltpack Name field at the top of the dialog box.



Figure 10-11: Registering a Beltpack

Note: At this stage the user can also change the label of the beltpack by over typing the value in the edit box shown here (currently containing the text "BPK01").

- Click the "Register" button in the "Registration" section of the dialog box.



Figure 10-12: Beltpack Serial Number

This performs two actions - firstly it sends the system number and DECT carrier mask information to the beltpack, and secondly it stores the serial number of the beltpack in the basestation configuration.

If the program connects successfully with the beltpack, the "Serial Num" field will change to show its serial number.

Once a beltpack has been registered with the basestation it will have been programmed with the system number and DECT carrier mask information which should not change once the system is installed. The beltpacks can later be reassigned to different slots on the same basestation via the configuration editor or via the basestation front panel.

It is also possible to pre-register spare beltpacks and then add them to the system later by entering the beltpack serial number into the configuration editor or the basestation.

THE OVERVIEW BUTTON

Clicking the overview button shows a summary of the labels and serial numbers of the beltpacks registered in each slot.

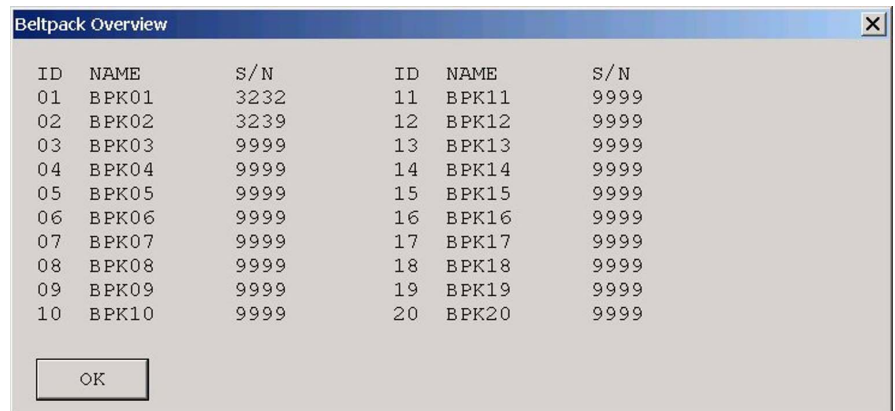

Figure 10-13: Beltpack Overview

Click on 'OK' to close the Overview window.

THE SET DEFAULTS BUTTON

The 'Set Defaults' button opens the beltpack defaults configuration screen. This allows the beltpack defaults to be configured and downloaded to a beltpack using the beltpack serial cable. Beltpack defaults can also be read back from a beltpack, the default settings

can be saved and restored in the editor and factory default settings recalled.

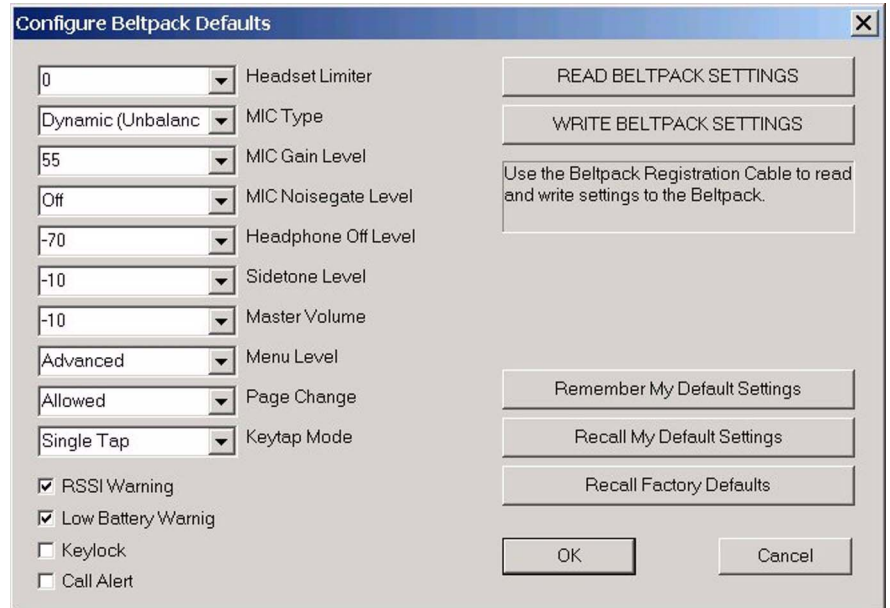

Figure 10-14: Beltpack Defaults Setup

To use the beltpack defaults facility the beltpack should be connected to the PC using the beltpack serial cable and the beltpack switched on.

Read Beltpack Settings

This button causes the configuration editor to read back the current settings from the connected beltpack and display them in the settings area.

Write Beltpack Settings

This button causes the configuration editor to write the current settings from the configuration editor to the connected beltpack.

Remember My Default Settings

This button saves the current beltpack default settings for later recall. This allows the user to ensure that all beltpacks are set up to the same default settings if required.

Recall My Default Settings

This button recalls the last saved default beltpack settings. This allows the user to ensure that all beltpacks are set up to the same default settings if required.

Recall Factory Defaults

This button recalls the factory default beltpack settings and can be used to reset beltpacks to the factory settings if the saved default settings have been lost or are not suitable.

Headset Limiter

Click on the down arrow to open a list of available headset limiter settings. The settings run from -32dB to +16dB in steps of 1dB. The factory default is 0dB.

MIC Type

Opening the drop-down menu displays the list of available headset microphone types. The microphone types are Dynamic (Balanced), Dynamic (Bnbalanced) and Electret. The factory default is Dynamic (unbalanced).

MIC Gain Level

Click on the down arrow to open a list of microphone gain level settings. The gain settings are in the range 20dB to 70dB in steps of 5dB. The factory default is 55dB.

MIC Noise Gate Level

Click on the down arrow to open a list of microphone noise gate level settings. The noise gate settings are in the range 1dB to 14dB in steps of 1dB or Off. The factory default is Off.

Headphone Off Level

Click on the down arrow to open a list of headphone off level settings. The available off level settings are -6dB, -12dB, -18dB and -70dB. The factory default is -70dB.

Sidetone Level

Click on the down arrow to open a list of sidetone level settings. The available sidetone level settings range from 0dB to -70dB. The factory default is -10dB.

Master Volume

Click on the down arrow to open a list of master volume level settings. The available master volume level settings range from 0dB to -70dB. The factory default is -10dB.

Menu Level

Click on the down arrow to display a list of menu level settings. These settings control the menus that can be accessed by the beltpack user. The settings are:

- Advanced - all beltpack menus are accessible to the user.
- Normal - the beltpack user cannot access the Microphone Type, Headphone Limiter and Local Assignment menus.
- Basic - the beltpack user cannot access any menus except the Contrast, Master Volume, Key Lock, Tap Latch, Page Lock and information menus.
- None - the beltpack user has no access to the menus and cannot change any beltpack settings.

The factory default is Advanced.

Page Change

Page change may be set to one of two values:

- Allowed - beltpack user can change page.
- Locked - beltpack user is restricted to preset page.

The factory default is Allowed.

Keytap Mode

Keytap mode (Tap Latch) determines whether the rotary push buttons latch with one press or two presses when set in latching mode. Keytap mode may be set to one of two values:

- Single Tap - rotary pushbutton latches after one press.
- Double Tap - rotary pushbutton latches are two presses.

The factory default is single tap.

RSSI Warning

The RSSI checkbox enables or disables the signal strength warning. Click on the checkbox to enable signal strength warning. The factory default is enabled (box checked).

Low Battery Warning

The Low Battery Warning checkbox enables or disables the battery warning. Click on the checkbox to enable low battery warning warning. The factory default is enabled (box checked).

Keylock

The Keylock checkbox enables or disables the deactivation of the beltpack scroll buttons after three seconds of inactivity. Click on the checkbox to enable keylock. The factory default is disabled (box unchecked).

Call Alert

The call alert checkbox enables or disables the call alert facility which uses the vibrate mode to signal the beltpack user that there is an incoming call. Click on the checkbox to enable call alert. The factory default is disabled (box unchecked).

ASSIGNING BELTPACK KEYS

The program can be used to assign the destinations of each of up to the six (three pages of two) soft assignments of the beltpack talk keys. The number of pages available on each beltpack for configuration can be set using the 'Pages' parameter. Click on the down arrow beside the page count to display the options for the number of pages the current beltpack can use.

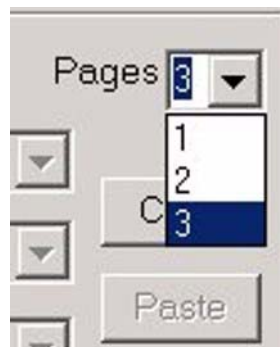

Figure 10-15: Beltpack Page Number

Select the required number of pages for the beltpack and the key valid key assignments are enabled for editing.

The screenshot shows a software interface for configuring beltpack key assignments. At the top, there are fields for 'Name' (BPK01) and 'Serial Num' (3232), along with 'Overview', 'Register', and 'Unregister' buttons. Below this is a section titled 'Key assignments' containing two checkboxes: 'Talk A Every Page' and 'Talk B Every Page'. To the right is a 'Pages' dropdown menu set to '3'. The main area features three rows labeled 'Pg1', 'Pg2', and 'Pg3'. Each row contains two columns of dropdown menus for key names and key types. For example, Pg1 has '4WR1' and 'Talk&List' in the first column, and 'HDSTA' and 'Talk' in the second. To the right of these rows are 'Copy' and 'Paste' buttons. At the bottom, there is a 'Reply key' dropdown set to 'REPLY' and a 'Clear' button.

Figure 10-16: Beltpack Key Assignments

Click on the down arrow beside each window to open a drop-down menu of all the available ports or key types and select the required item. The selected item will be displayed in the window.

If the key assignment is '----' then the beltpack key is locked and cannot be used.

The 'Talk A Every Page' checkbox allows the key A assignment for page 1 to be copied to key A on any other page that is enabled and made non-editable (greyed out). The 'Talk B Every Page' checkbox copies the page 1 assignment for key B to key B on any other enabled page and disabled for editing. If a 'Talk A Every Page' or 'Talk B Every Page' box is unchecked the forced assignments are cleared and the pages enabled for editing.

The 'Copy' and 'Paste' buttons are used to copy the setup of the current beltpack and paste that setup onto another beltpack. This allows the rapid configuration of beltpacks where many have the same setup.

The 'Clear' button clears all key assignments for the current beltpack.

THE REPLY KEY

The key in the centre of the face of the beltpack is known as the reply key. The configuration of this key is the same across all three pages of the beltpack. It can be configured in the following ways:

- *As a reply key:* Selecting REPLY from the drop-down box next to the "Reply key" text configures the key as a standard reply key. When anyone calls this beltpack, the centre LEDs will flash and the label of the caller will appear in the display above the centre key. The beltpack user can reply to the call by pushing the centre key.
- *Assigning a call destination:* Pushing the centre key on any page will call this destination. For example, if "STGAN" is selected from the drop-down box, the user knows that they can always activate the stage announce by pushing the centre key, whatever page of

the beltpack they are on. The label of "STGAN" will appear in the display above the key on all pages.

The key type will be enabled allowing the reply key to be configured as Talk, Listen, Talk & Listen, Dual Talk & Listen, Forced Listen or Talk & Forced Listen.

- *Locked*: Selecting '----' de-activates the centre key. Five dashes "-----" will appear in the display above the key.

Note that in the last two cases there is no mechanism for replying to sources that call the beltpack which do not have keys on the beltpack assigned to them.

KEY ASSIGNMENT TYPES

By default an assignment is talk only; however 4-wire and partyline inputs can be selected as the following:

- *Listen*: The callee can be heard, but no outgoing audio path is created when the key is pressed.
- *Talk and listen (Talk&List)*: An outgoing and incoming audio path is created when the key is pressed - that is the audio from the callee can be heard without them having to initiate a return path.
- *Dual talk and listen (Dual T&L)*: A short press produces a latching listen path, while a long press produces a momentary talk.
- *Forced listen (Frc L)*: Assigning a key in this way forces a permanent listen path - that is the remote source can be heard on the beltpack even when the key is not latched on. No talk path is created when the key is pressed. This may be useful for monitoring a program input or directors feed.
- *Talk and forced listen (T&F L)*: The same as a Forced Listen key, except a talk path is created when the key is pressed.
- *Talk*: The key will only create an outgoing audio path when pressed.

The type of a key is indicated on the beltpack with the use of different cases for the label: a Talk key is shown in all capitals, e.g. "TEST". A listen key is shown in all lower-case, e.g. "test". Dual Talk and Listen, and Talk and Forced Listen keys are indicated by an initial capital, with the rest in lower case, e.g. "Test".

Latching keys

Selecting the "Latching talk" check box makes all keys configured as Talk, Talk and Listen, or Talk and Forced Listen have a latching action - a short "stab" latches the key on, while a longer press causes the audio path to terminate when the user releases the key.

If this check box is cleared, Talk, Talk and Listen, and Talk and Forced Listen keys have a momentary action - the user has to hold the key down as long as they want to talk to the remote user.

Listen and Dual Talk and Listen always have a latching action regardless of the setting of this check box.

On Page Change Cut

Checking the Talk or Listen boxes will cause Talk or Listen audio paths on the current page to be cut when a different page is selected. The audio paths will be restored when the page is reselected.

Menu

The 'Menu' setting allows access to menus on the beltpack to be restricted to one of four levels; Advanced, Normal, Basic and None. Clicking on the 'Menu Disable' checkbox automatically selects the 'Normal' setting.

Advanced Menu Setting

All menus on the beltpack are enabled allowing the user to modify any local settings on the beltpack.

Normal Menu Setting

The beltpack Microphone Type, Headphone Limiter and Local Assignment menus are locked.

Basic Menu Setting

All beltpack menus are locked except the Contrast, Master Volume, Key Lock, Tap Latch, Page Lock and information screens.

None Menu Setting

All beltpack menus are locked out from access or viewing.

INPUT AND OUTPUT LEVELS

The input level (a biasing factor applied to the audio mix of other users which adjusts the level at which other users will hear this beltpack) and the output level (the level at which the beltpack hears other users) can be adjusted between -20 and +6dB.



Figure 10-17: Input and Output Levels

PORTS TAB

This allows the user to change the settings of front panel headset, 4-wire and partyline connections.

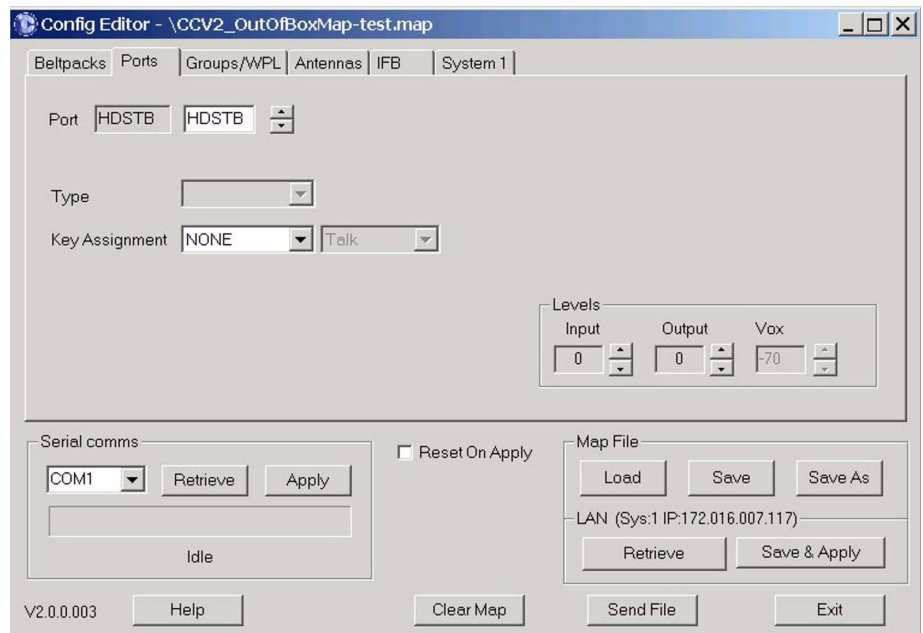

Figure 10-18: Ports Tab

SELECTING THE PORT TO EDIT

Select which of the audio ports is to be edited using the arrow buttons next to the right of the label edit box.

CHANGING THE LABEL OF THE PORT

Select the port to be changed, then over-type the text in the label edit box.

TYPE DROP-DOWN BOX

This is only active when a partyline port is selected. It allows the user to select between Clear-Com, Drake, RTS and OFF party line settings. This affects the gain, termination and call signaling used when communicating with this port.

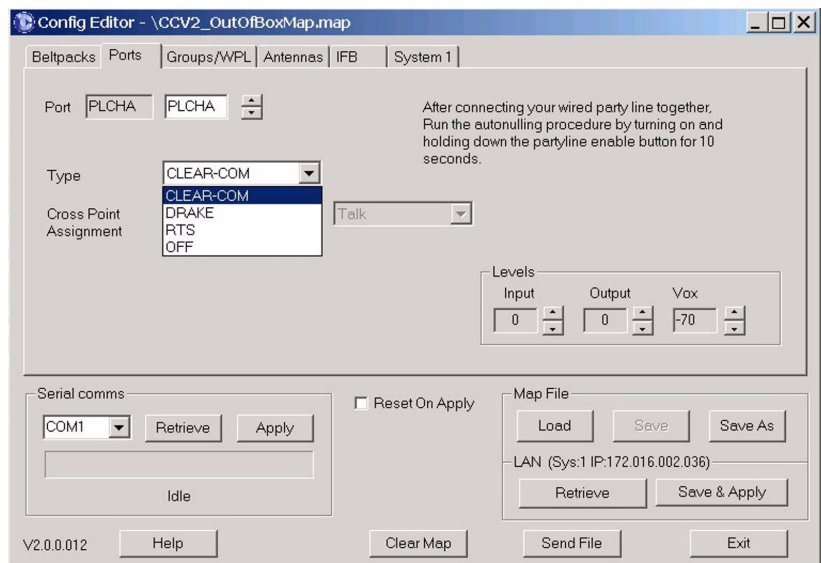

Figure 10-19: Party Line Port Type Menu

- Clear-Com - selects Clear-Com party line compatibility with termination enabled.
- Drake - selects Drake party line compatibility with termination enabled.
- RTS - selects RTS compatibility with termination enabled.
- OFF - termination disabled on party line port.

CROSS POINT ASSIGNMENT DROP-DOWN BOX

This is only active for headset, partyline and 4-wire ports and IFBs. For a front panel headset port, it specifies the port which is called when the "Talk" button for that port is pushed.

For a partyline or 4-wire port, it causes a permanent talk path to be created from the port to this destination.

For an IFB it creates an IFB from the port to the destination.

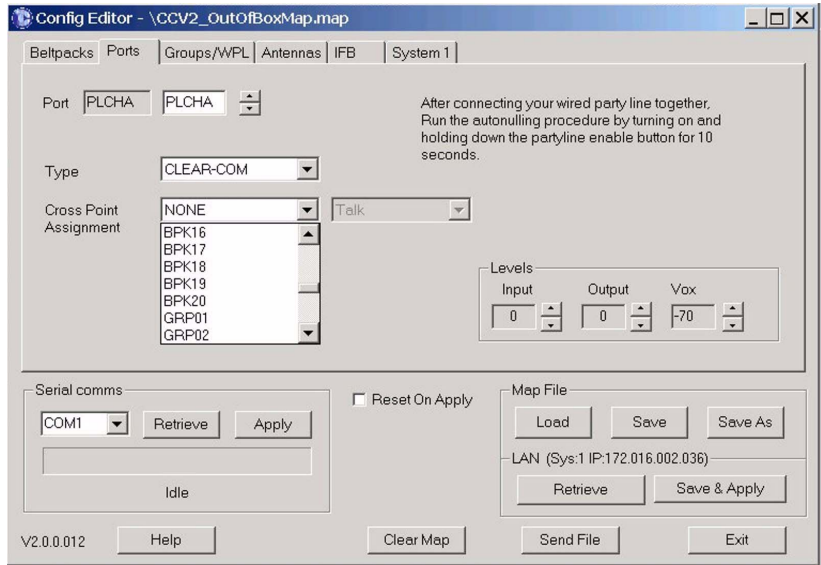

Figure 10-20: Cross Point List for Port

Select the cross point assignment from the drop-down list then open the cross point type menu and select the type.

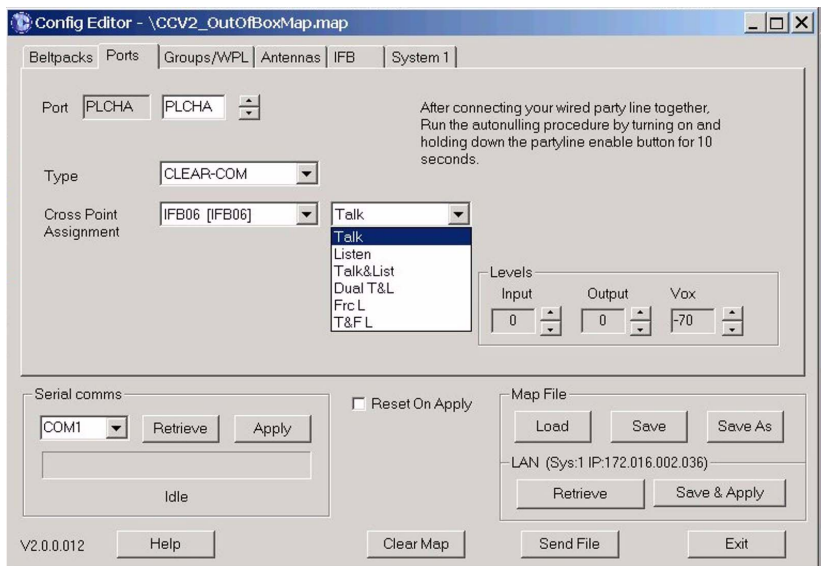

Figure 10-21: Party Line Crosspoint Type

INPUT AND OUTPUT LEVELS

The input level (a biasing factor applied to the audio mix of other users which adjusts the level at which other users will hear this port) and the output level (the level at which the port hears other users) can be adjusted between -20 and +6dB.

The Vox level specifies the audio level at which the audio path is made if the use of Vox is enabled. The Vox trigger level can be set in the range -70dB to -10dB.

GROUPS TAB

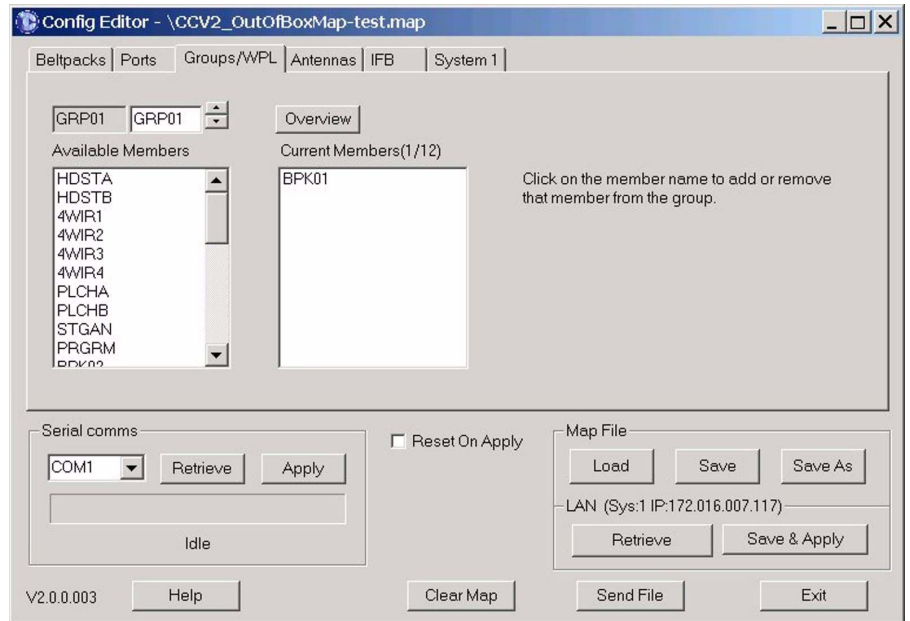

Figure 10-22: Groups Tab

SELECTING THE GROUP TO EDIT

Select which of the ten available groups is to be edited using the up/down arrow buttons next to the right of the label edit box.

CHANGING THE LABEL OF THE GROUP

Select the group to be changed, then over-type the text in the label edit box.

CHANGING THE MEMBERS OF THE GROUP

The groups tab displays two lists of members; the “Available Members” lists shows the members available to be placed in the current group and the “Current Membership” list shows the current group members.

To place a new member into the group move the mouse pointer over the member in the available list and single click. The member will be transferred to the group membership list. To remove a member from a group place the mouse pointer over the member and single click. The member will be transferred from the group membership list to the available members list.

GROUP OVERVIEW

Click on the "Overview" button to display an overview of group membership for all groups.

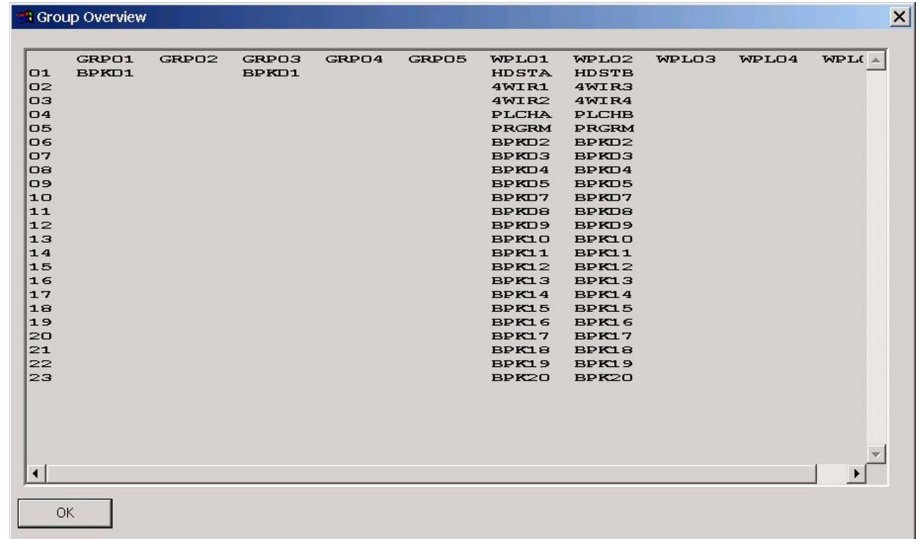

Figure 10-23: Group Overview Display

The groups are listed along the top and the total membership of all the groups is listed down the side. Wherever a member of a group is online an 'x' will be displayed on the view at the intersection between the member and the group.

ANTENNAS TAB

Due to propagation delays along the cables, antennas which are in close proximity but which have effective cable lengths which differ by more than approximately 150m can interfere with each other. This screen allows the user to compensate for the length of the connection of each of the 10 available antennas.

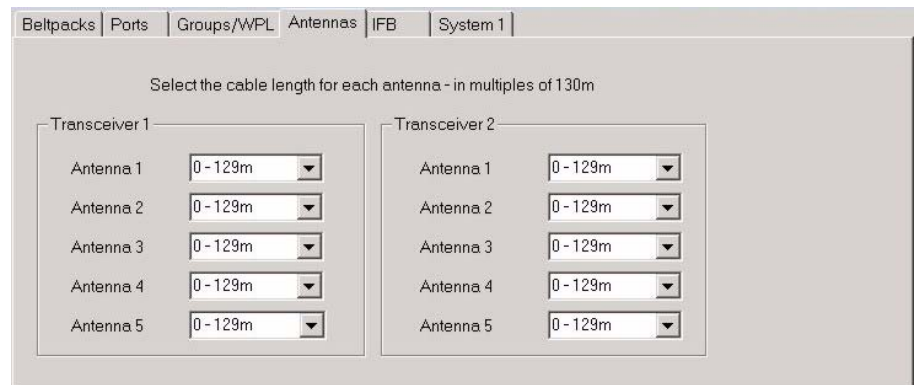

Figure 10-24: Antennas Tab

The cable length for each antenna should be set by clicking on the down arrow to open the drop-down list of cable lengths and selecting the appropriate cable length from the list.

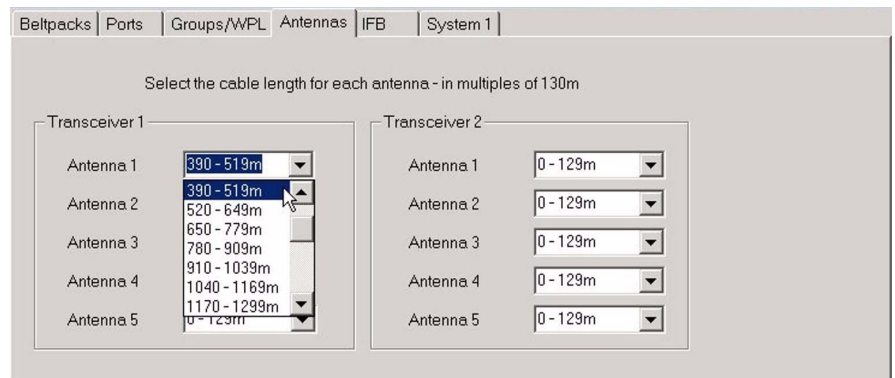

Figure 10-25: Antenna Cable Length Setup

Once the cable lengths have been set the changes should be downloaded to the basestation.

IFB TAB

The IFB tab displays the IFB configuration screen allowing IFB sources and destinations to be assigned to an IFB label and the dim level to be set for the IFB.

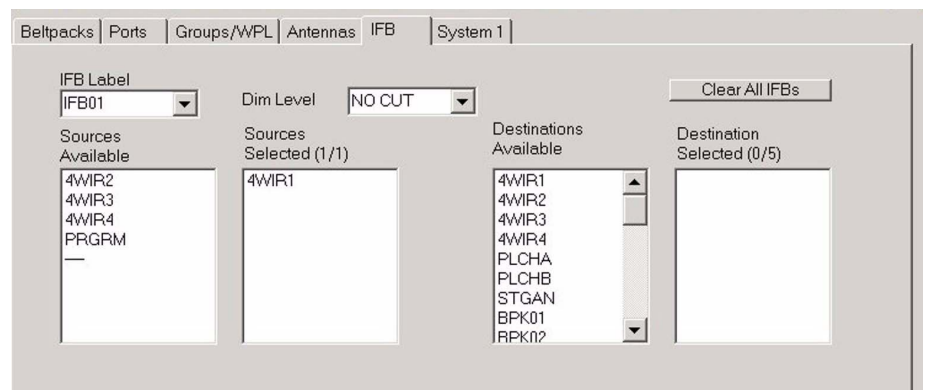

Figure 10-26: IFB Configuration Tab

CONFIGURING AN IFB

To select an IFB label click on the down arrow beside the the current IFB label to open the drop-down list of IFB labels. Click on the required label to select it.

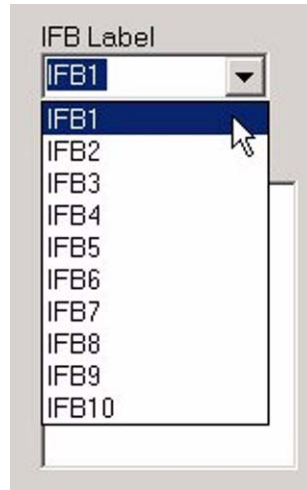

Figure 10-27: IFB Selection List

To edit the name of the label select the name in the “IFB Label” box and edit the label name.

To set the dim level for the IFB (the audio dimming applied to the audio feed when an IFB is activated) click on the down arrow beside the “Dim Level”. A drop-down list is displayed showing the available dim level. Click on the required dimming level to set it.

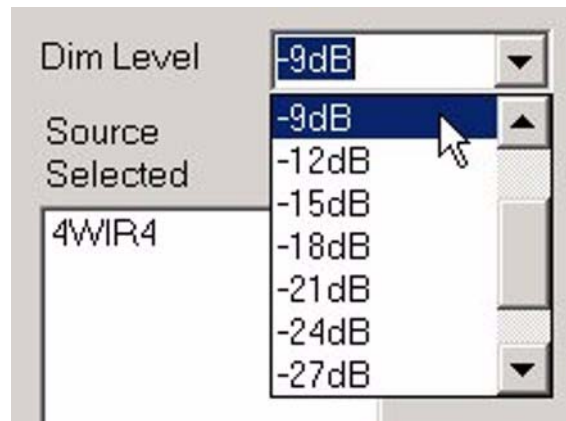

Figure 10-28: Dim Level List

To assign an IFB source move the mouse pointer over the source in the available sources list and single click. The IFB source will be transferred to the selected sources list for that IFB label. To remove a source from an IFB place the mouse pointer over the source in the “Source Selected” list and single click. The source will be transferred from the selected list to the available source list.

To assign an IFB destination move the mouse pointer over the destination in the available destinations list and single click. The IFB destination will be transferred to the selected destinations list for that IFB label. To remove a destination from an IFB place the mouse

pointer over the destination in the “Destinations Selected” list and single click. The destination will be transferred from the selected list to the available destination list.

SYSTEM TAB

Enter the IP address to be assigned to the basestation. This address will become effective on a map download that restarts the basestation.

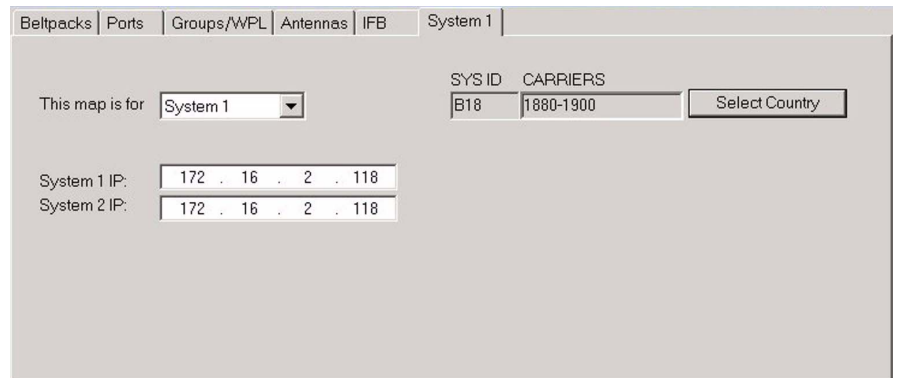

The screenshot shows a software window titled "System 1" with several tabs: "Beltpacks", "Ports", "Groups/WPL", "Antennas", "IFB", and "System 1". The "System 1" tab is active. Inside the window, there is a dropdown menu labeled "This map is for" with "System 1" selected. To the right, there are two input fields: "SYS ID" containing "B18" and "CARRIERS" containing "1880-1900". A "Select Country" button is located to the right of the "CARRIERS" field. Below these fields, there are two rows of IP address input fields. The first row is labeled "System 1 IP:" and the second row is labeled "System 2 IP:". Both rows contain the IP address "172 . 16 . 2 . 118".

Figure 10-29: System Tab

The basestation must be configured to use the correct frequency range for the country of use. To enter this click on the ‘Select Country’ button. The service password will be required to enter this facility.

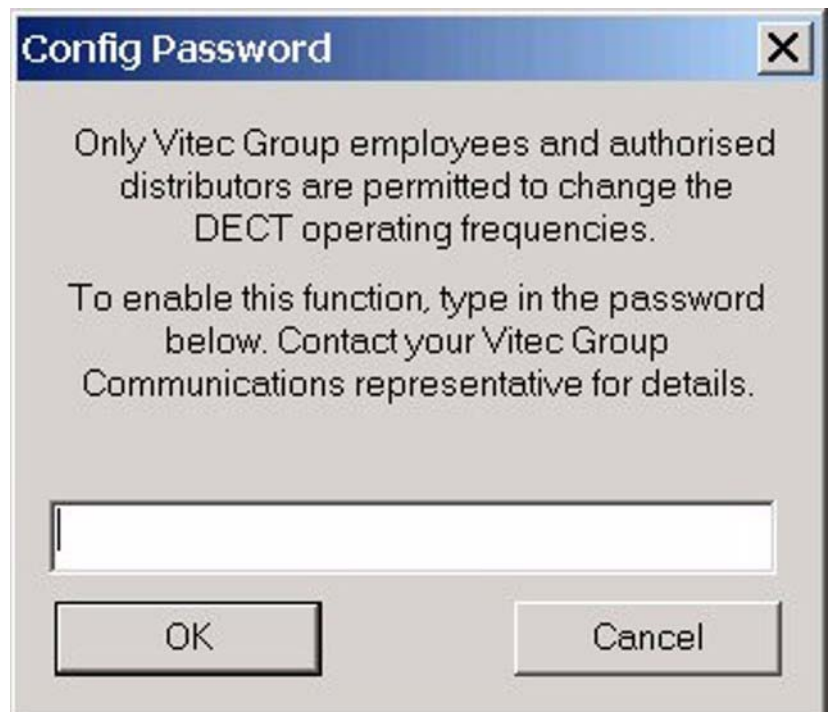

The screenshot shows a dialog box titled "Config Password" with a close button (X) in the top right corner. The text inside the dialog box reads: "Only Vitec Group employees and authorised distributors are permitted to change the DECT operating frequencies. To enable this function, type in the password below. Contact your Vitec Group Communications representative for details." Below the text is a large empty text input field. At the bottom of the dialog box are two buttons: "OK" and "Cancel".

Figure 10-30: Password Entry

When the correct password is entered confirmation screen is displayed.



Figure 10-31: Password Entered

the country list is displayed. Click on the required country or region to set the correct frequency range for the unit to operate.

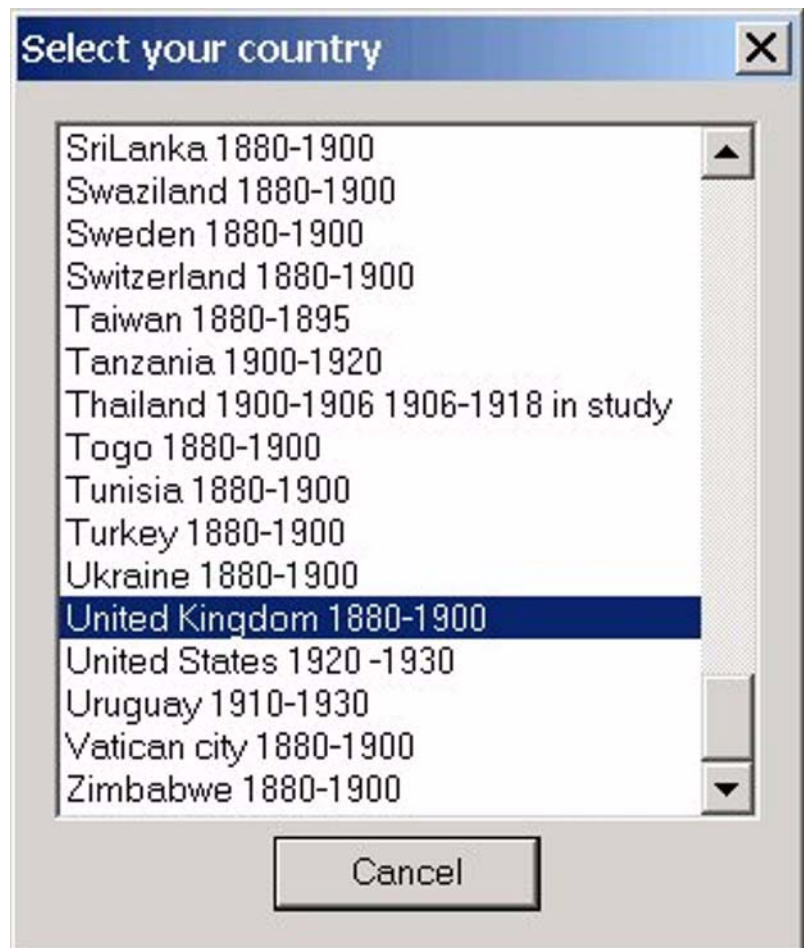

Figure 10-32: Country Setup

Click on the 'Cancel' button to exit without changing the setting or click on the exit box to change the setting.

DECT CARRIERS

This shows the range of RF carriers that the basestation is currently using, in MHz. The carriers that a unit is permitted to use vary from country to country. Authorized service personnel and distributors may change this value after entering a password - contact ClearCom sales for details.

SYS ID

This shows part of the DECT system ID, which the beltacks use to identify which basestation to communicate with, and vice versa.

SYSTEM NUMBER

The system tab can be used to configure two systems, named as 'System 1' and 'System 2'. The system is selected by clicking on the down arrow next to the 'This map is for' window.

IP addresses can be set up for System 1 and System 2 allowing the configuration editor to be used to create and download maps to two basestations.

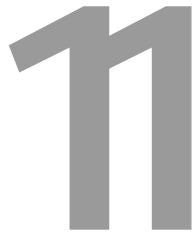

FREESPEAK TOOLKIT

INTRODUCTION

The FreeSpeak Toolkit is a suite of PC programs running under Windows 2000 or above, designed to allow the user to set up, backup, and upgrade the FreeSpeak basestation and run diagnostics on the basestation.

The distribution CD also includes a separate toolkit for upgrading the firmware on beltacks and antennas.

CONFIGURATION EDITOR

The Configuration Editor is used to register beltacks, create and back up basestation configurations, download new configurations to basestations and back up and restore basestation configurations made from the basestation front panel.

The Configuration Editor also upgrades the basestation firmware when a new version is released via the Ethernet port.

BASESTATION SERIAL FIRMWARE UPGRADER

The basestation serial firmware upgrader is used to upgrade the basestation firmware when a new version is released via the Serial cable.

BELTPACK AND ANTENNA SERIAL FIRMWARE UPGRADER

The beltack and antenna serial firmware upgrade is used to upgrade the beltack and antenna firmware when a new version is released via the Serial cable.

DIAGNOSTIC PROGRAM

The diagnostic program connects to the basestation via a serial link and may be used to investigate problems with the system.

TOOLKIT INSTALLATION

To install the FreeSpeak toolkit follow the link on the installation/upgrade CD and click on the installation executable "CellCom FreeSpeak V2.0 Toolkit 710838.exe". If a FreeSpeak toolkit is already installed on the system the FreeSpeak toolkit installer will remove it before installing the V2.0 toolkit.

The FreeSpeak toolkit contains the Basestation Configuration Editor, Basestation Configuration Editor help, the FreeSpeak diagnostics program, Basestation Serial Upgrader and Beltpack/Antenna Serial Upgrader.

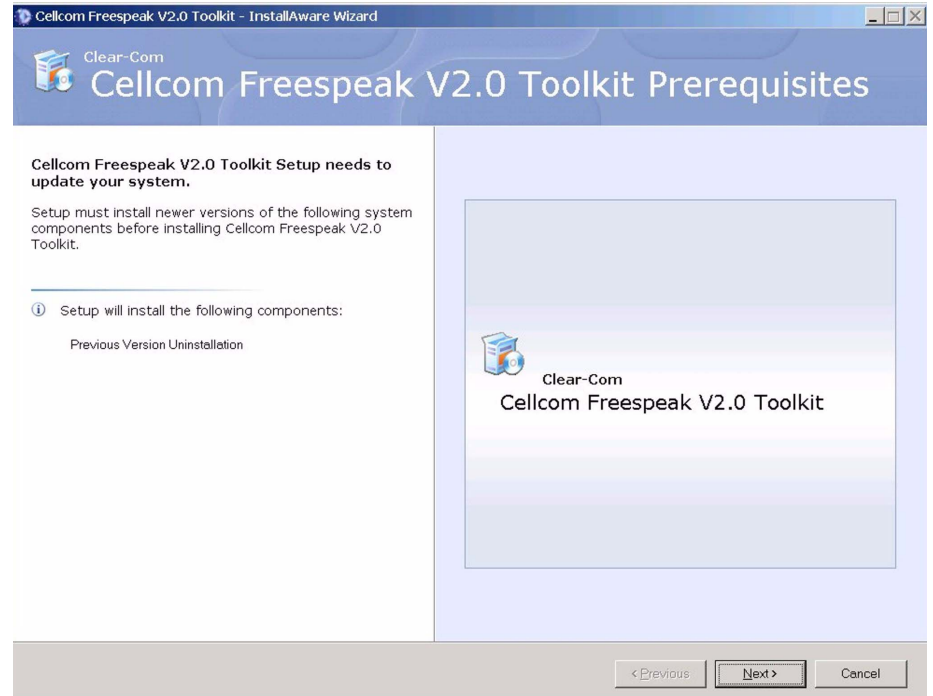

Figure 11-1: Previous Version Uninstall

Click on 'Next' to proceed with the uninstall of the previous toolkit. Once the previous version has been removed the following installation startup screen will be displayed.

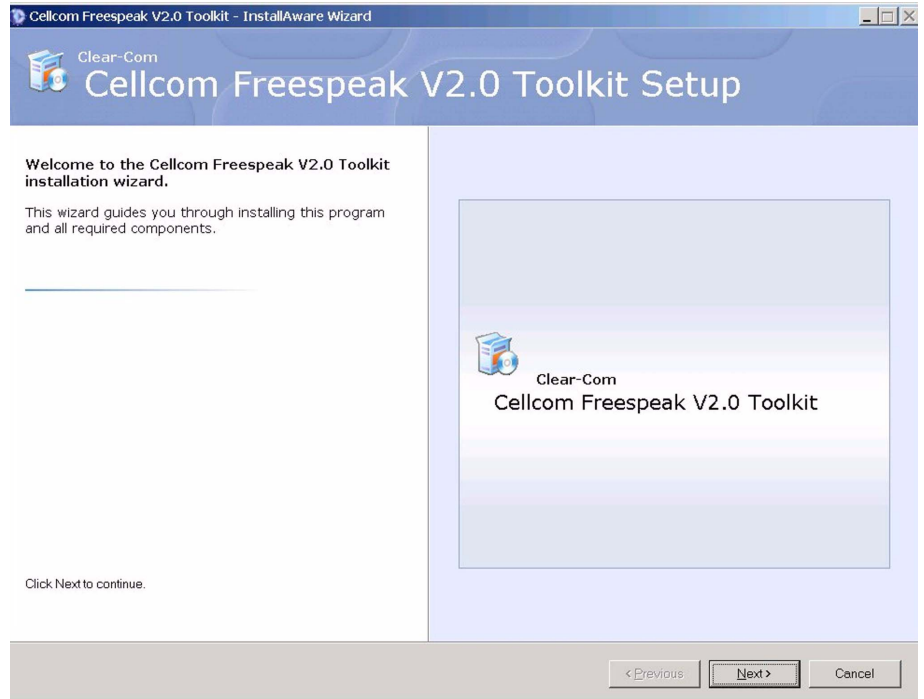

Figure 11-2: Toolkit Install Startup

Click on the 'Next' button to continue the installation. The installer will request a name for identification and company name.

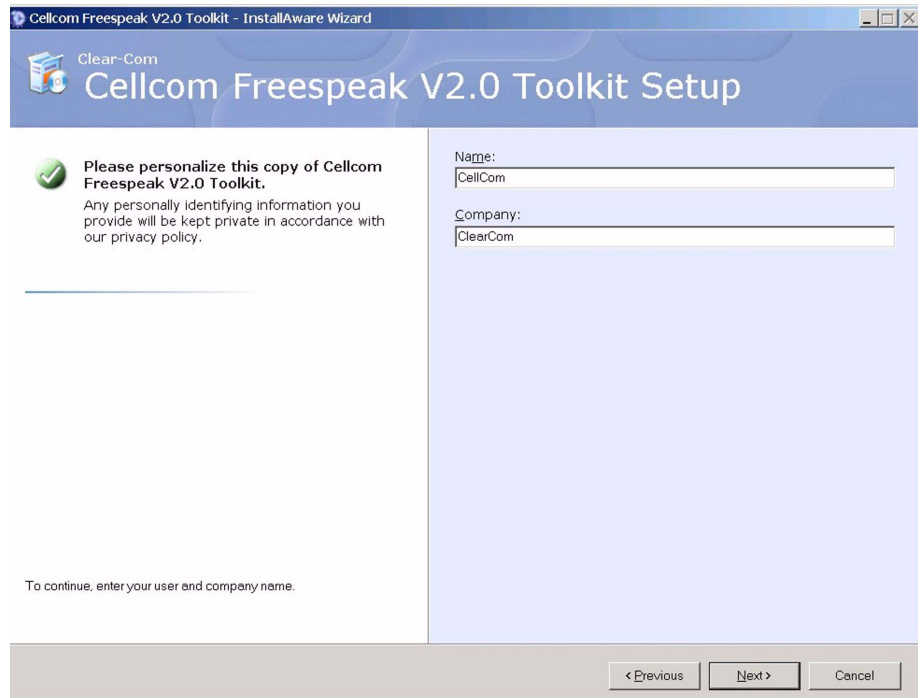

Figure 11-3: Toolkit Installer Names

Enter the required information and click on the 'Next' button. The installation requirements screen will be displayed by the installer.

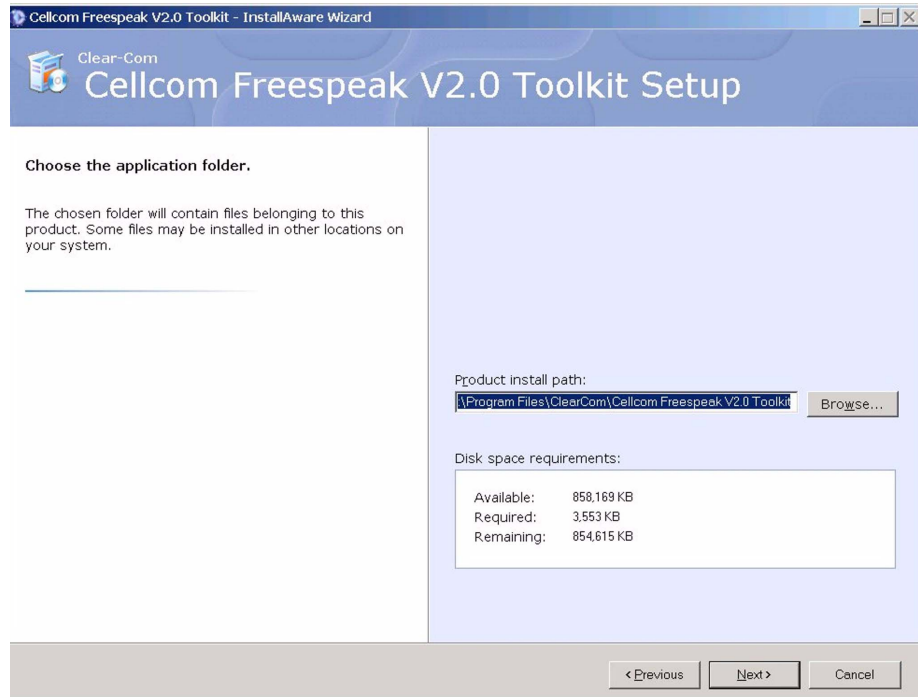

Figure 11-4: Toolkit Installation Path

Either accept the proposed installation path or use the 'Browse' function to select a new installation path. Check that there is sufficient space available to complete the toolkit installation and click on the 'Next' button to continue the installation. The toolkit shortcuts setup screen will be displayed.

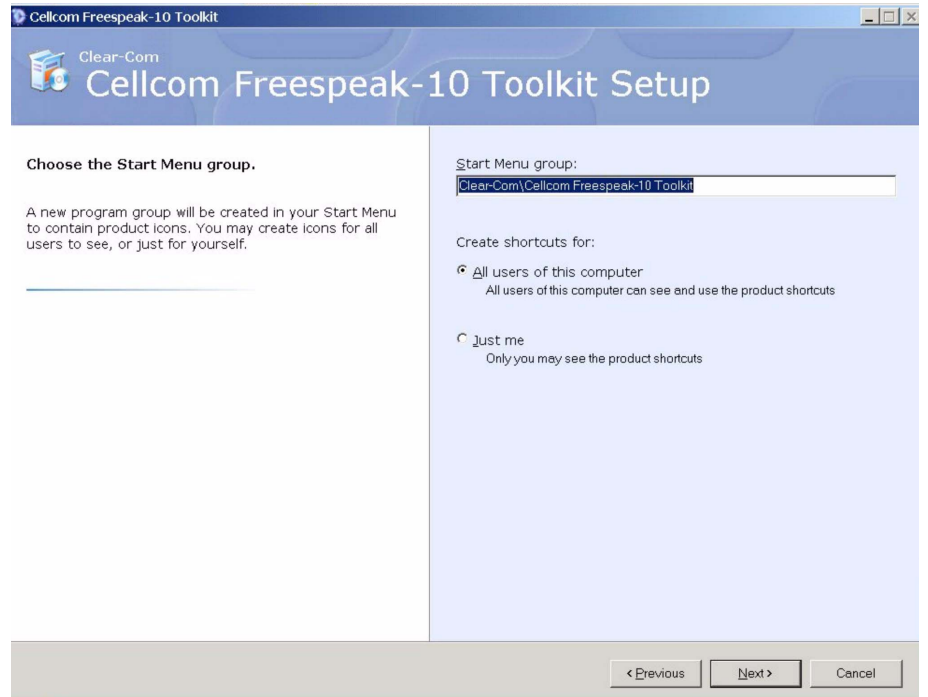

Figure 11-5: Toolkit Start Menu Setup

Either accept the default start menu name or enter a new menu. Select whether all users or just the installing user should be able to see the toolkit shortcuts and click on the 'Next' button to continue. The installer confirmation screen will be displayed.

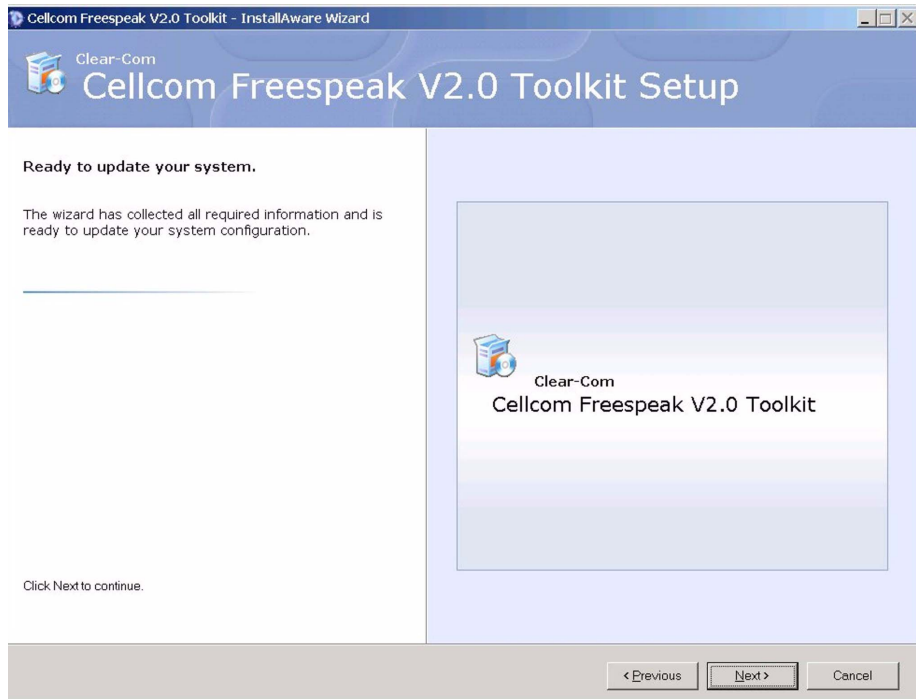

Figure 11-6: Toolkit Install Confirm

Click on the 'Next' button to install the toolkit. The toolkit software will be installed and a completion screen will be displayed.

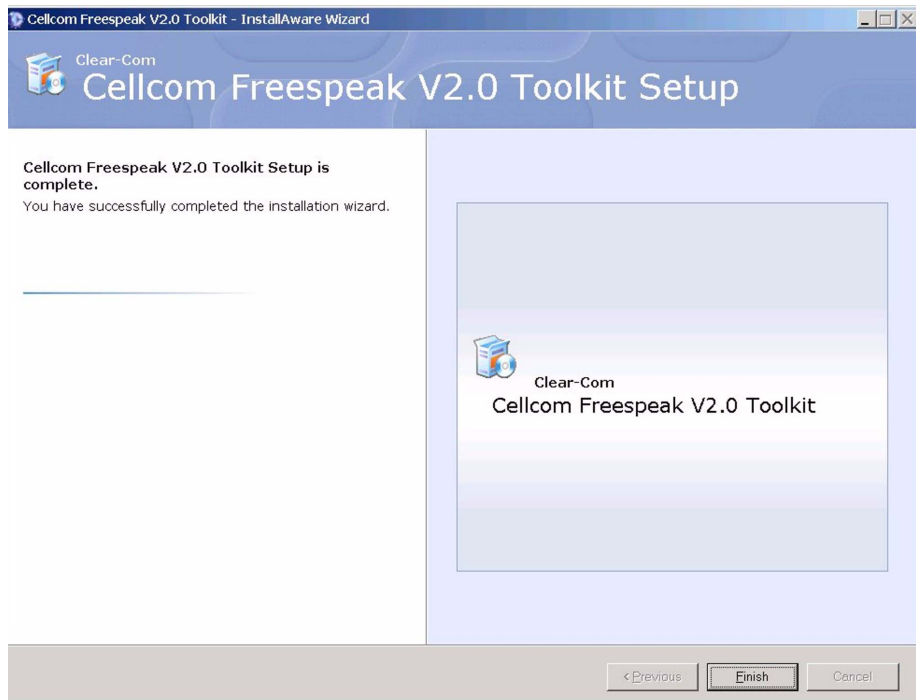

Figure 11-7: Installation Completion Display

Click on the 'Finish' button to complete the toolkit installation.

BELTPACK REGISTRATION

Registration is the process of telling the beltacks which basestation to communicate with, and telling the basestation which beltacks to communicate with.

In some cases the beltacks shipped with the basestation may already be registered to it, in which case there is no need to use this tool immediately. However the user will need to use it if they are not registered, or if new beltacks are shipped to replace faulty or damaged ones, or if there are a number of basestations and it is required to switch beltacks between them.

The registration process involves two steps: firstly entering the beltack serial numbers into the basestation, and secondly programming the beltacks with the basestation system ID.

ENTERING BELTPACK SERIAL NUMBERS INTO THE BASESTATION

- From the basestation front panel, select "BELTPACKS", and then the "slot" of the beltack that the new unit is to be put in, e.g. BPK01.
- Select RGSTR. The user should now see a menu titled "Enter beltack S/N for..." with 4 digits underneath.
- Each beltack should have a sticker on its rear indicating its serial number. (If this sticker is missing or damaged, this serial number can be read using the PC app – see later). Dial the last 4 digits of this serial number into the basestation, then select BACK, then BACK again to return to the list of beltack slots.
- Repeat the process for all the beltacks that are to be registered.
- Apply the changes by either holding down the rotary controller for 5 seconds (this must be done after selecting BACK from the Register menu) or by selecting "SYSTEM>SAVE" from the main basestation menu.

To de-register a beltack, from the basestation front panel, select BELTPACKS, then the slot where the beltack is currently registered, then RGSTR, and enter "0 0 0 0" as the serial number.

ENTERING THE BASESTATION SYSTEM ID INTO THE BELTPACK

- Connect the beltack to the PC using the beltack serial cable (9 way female DIN to 3.5mm stereo jack). If one of these cables was not shipped with the FreeSpeak unit, the pinout is described in the Figure 11-2. Power up the beltack.

- Run the Configuration Editor and select the COM port that the serial cable is attached to on the PC. Please refer to chapter 10 “FreeSpeak Configuration Editor” for instructions on using the Configuration Editor to register the beltpack.
- Power cycle the basestation and the beltpacks, and check that they communicate successfully with each other.

BASESTATION SERIAL UPGRADER

This application is used to upgrade the firmware of the FreeSpeak basestation when a new version is released.

It connects to the basestation using a crossover (Null-Modem) serial cable plugged into the “PC PROGRAM” port. If this cable was not shipped with the FreeSpeak unit, the pinout is described in Figure 11-1. It expects to be connected to COM port 1 of the PC.

UPGRADING THE BASESTATION FIRMWARE

On launching the application a dialog box like this should appear.

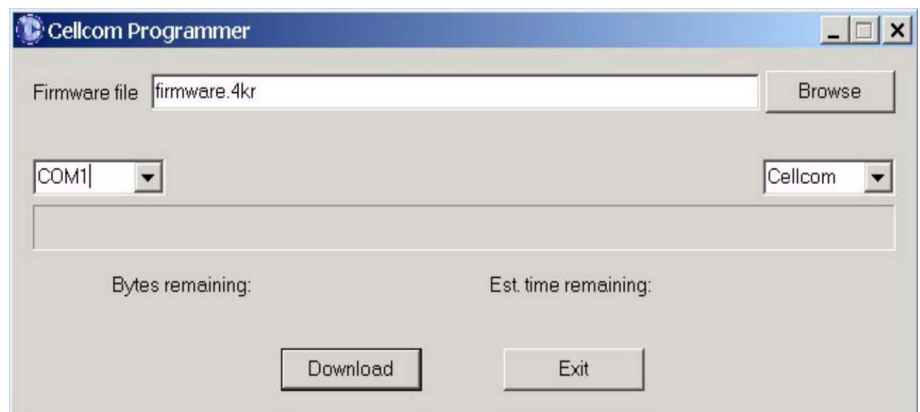

Figure 11-8: Upgrading Basestation Firmware

Select “Browse”, and navigate to the location of the new basestation firmware file. The firmware file will have a “.4kr” file extension.

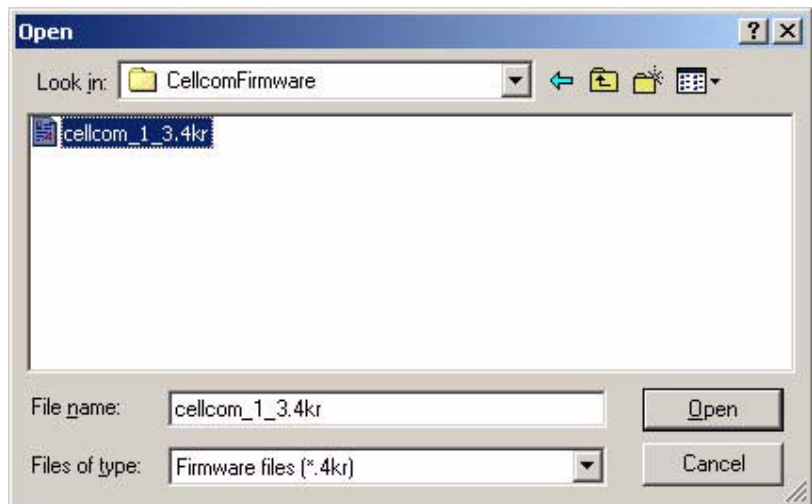

Figure 11-9: Select Firmware File

Select the file, then press “Open”. The main application dialog box will now show the date of the new file, as below.

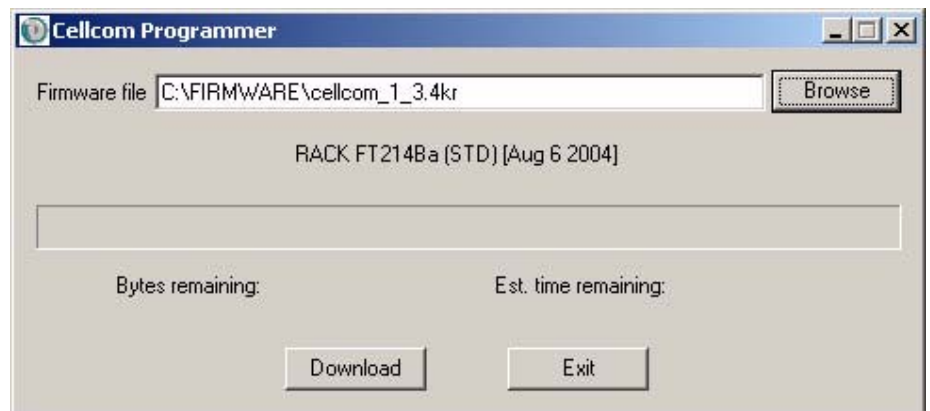

Figure 11-10: Firmware Download

Press “Download” to start the download process. If the program communicates successfully with the basestation, the progress bar will start to advance. Diagnostic messages indicating that a download is in progress will also appear on the basestation front panel display.

Download of the file should take around fifty minutes to an hour to complete.

If the program fails to communicate with the basestation, after a few seconds an error dialog will be displayed:



Figure 11-11: Download Timeout

If this occurs, check the serial cable and all connections.

The download process can be aborted at any time without harm to the FreeSpeak unit by pressing the "Exit" button. The FreeSpeak unit can also be powered off safely except when "Firmware successfully downloaded – Flashing and running" is displayed on the front panel display.

BELTPACK SERIAL UPGRADER

The beltpack serial upgrader is a separate tool that is not part of the toolkit and is installed from the CD.

INSTALLING THE BELTPACK UPGRADER

Navigate to \Firmware\PC Tools\Beltpack_Updater\v1.0.5 and run "setup.exe".



Figure 11-12: Beltpack Upgrader Installation Start

Click on the 'OK' button when ready to proceed. The option to select the installation directory will be displayed.



Figure 11-13: Set Installation Directory

It is recommended that the default installation directory is accepted. Click on the installation button to continue the installation.

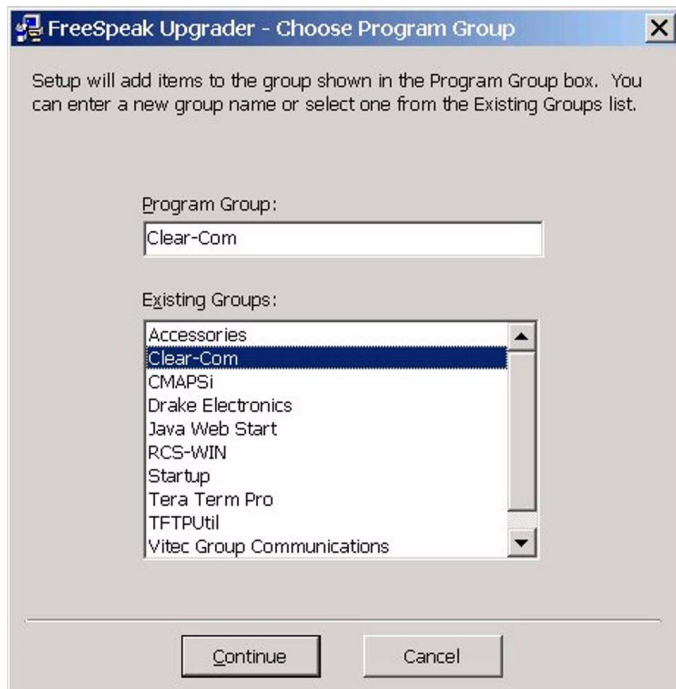

Figure 11-14: Beltpack Upgrader Program Group

Normally the Clear-Com program group should be selected. Click on 'Continue' to proceed with the installation. The installation files will then be copied to the destination directory.

In some cases the installer may display a message indicating that a system file is a more recent version than the one in the installer.

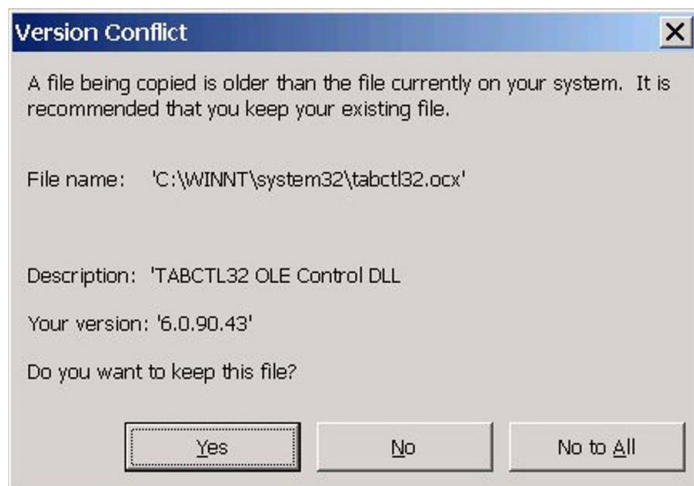

Figure 11-15: Installer Version Conflict

It is recommended that the current version of the file is kept. When the installation is complete a confirmation is displayed.



Figure 11-16: Installation Completed

Click on 'OK' to exit the installer.

RUNNING THE BELTPACK UPGRADER

To use the beltpack upgrader connect the beltpack serial cable to the COM port of the PC and the beltpack to be upgraded and switch the beltpack on. Run the beltpack upgrader program and click on the '...' button to navigate to the required firmware file (.mot). The COM port can be set by opening the 'File' menu and clicking on the 'COM Port' entry. Select the COM port from the drop-down list.

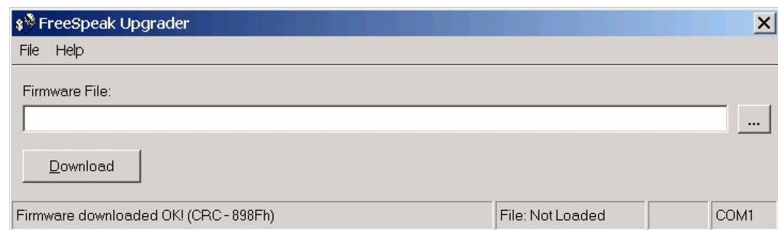

Figure 11-17: Beltpack Upgrader Startup

Once the firmware file has been selected click on the 'Download' button to start the upgrade. A progress bar will be displayed as the beltpack upgrade is carried out. The beltpack screen will display a message to indicate that the upgrade is in progress.



Figure 11-18: Beltpack Upgrade Progress

When the beltpack upgrade is complete the upgrade program can be closed and the cable unplugged. The beltpack is now ready for use.

BASESTATION PROGRAMMING SERIAL CABLE PINOUT

Standard Null-modem cable with data Send and Receive crossed over.

PC Connection usually 9 way Female D-type connector	Basestation connection 9 way Male D type connector
1	N/C
2	3
3	2
4	N/C
5	5
6	N/C
7	N/C
8	N/C
9	N/C

Table 11-1: Null-Modem Cable Pinout

BELTPACK PROGRAMMING SERIAL CABLE PINOUT

PC Connection usually 9 way Female D-type connector	Beltpack connection 3.5mm Stereo jack plug
1	N/C
2	Tip
3	Ring
4	N/C
5	Screen
6	N/C
7	N/C
8	N/C
9	N/C

Table 11-2: Beltpack Programming Serial Cable Pinout

12

SPECIFICATIONS

FreeSpeak FS-BASE Basestation

Basestation-to-Beltpack Frequency Response	100 Hz – 7.1 kHz
Number of FS-BP Beltpacks per Basestation	20
Number of FS-TA Transceiver/ Antennas Supported by Basestation: 10	
Number of Transceiver/ Antenna Ports	2
Programming Port	DB9
Relay Port	DB9; normally open and normally close wiring
Party-Line Intercom A and Intercom B (each)	XLR-3F with XLR-3M loop through, on/off termination switch (via software), Clear-Com RTS selection (via software)
4-Wire/Matrix Connection	4 RJ-45 for 4-wire (Intercom 3 – 6)
Program Input	XLR-3F, transformer isolated, line-level input
Stage Announce Output	XLR-3M, transformer isolated, line-level output
Front-Panel Headset	4-pin male connector with 2-channel, mono-summed capability and individual talks and listens
Front Panel Display	254 x 32 dot-graphic VFD
Front Panel Indicators	2 Talk LED's for front-panel headset; CH A and B party-line enable LED's; Program Input enable LED; 10 individual beltpack LEDs
Basestation Programming/Editing	Push-to-enter rotary encoder

Dimensions 1-RU unit, 44 x 483 x 312 mm (hwd)
(1.75 x 19.0 x 12.5 inches)

Weight Approx. 10 lb.

FreeSpeak FS-BP Beltpack

Beltpack Frequency Response 100 Hz – 7.1 kHz

Beltpack Assignment-Select Buttons 3, used to scroll and select talk/listen pages” and also to edit beltpack menu options

“Label” Assignments per Select Button 2 (two simultaneous talk/listen paths or channels)

Number of Full-Duplex Audio Paths 6 (3 pairs), with individual level control

Level/Talk Controls 2 top-mounted push-to-talk rotary encoders

Headset Connector 4-pin male, Clear-Com standard

Headset Impedance 32 ohm to 2000 ohm

Microphone Type Dynamic or electret, selectable in beltpack menu

Microphone and Headset Limiters Selectable in beltpack menu

Powering Alkaline Battery, 4 AA alkaline cells
Rechargeable, 4 NiMH cells in AA format

Battery Charging In unit, via supplied external power supply connected to beltpack

Battery Life Approximately 8 hours with 4 fresh AA alkaline batteries or 4 AA high-amperage NiMH cells

Range from Single FS-TA Transceiver/Antenna 125 m from transceiver/antenna in line-of-sight conditions; 50 m indoors; use multiple FS-TAs for larger, custom coverage areas

Dimensions Tapered design, at largest points approx. 38 x 87 x 144 mm (dwh)
(1.5 x 3.5 x 5.75 inches)

Weight (with batteries) Approx. 13 oz.

Transceiver/Antenna

Beltpacks Supported Per
Transceiver/Antenna 5, in one cellular zone

Transceiver Antenna Transmission
Range Up to 250 m (800 ft.), line of sight

Maximum Distance, Basestation to Transceiver
Via Basestation Port 1,000 m (3,200 ft.) using 24 AWG cable
500 m (1,600 ft) using 26 AWG cable

Maximum Distance, Transceiver Powered
By Basestation Port 300 m (975 ft.)

Local Powering Via 24VDC power supply

Range per FS-TA Transceiver/Antenna 150 m from transceiver/antenna
ideal, line-of-sight conditions; 50 m
indoors; use multiple FS-TAs for larger,
custom coverage areas

Connection to FreeSpeak Basestation RJ-45

Mounting Via integral tabs with holes for screws

Dimensions 38 x 125 x 153 mm (dwh)
(1.5 x 5.0 x 6.1 inches)

Weight Approx. 9 oz.

Transceiver/Antenna Splitter

Number of Transceiver/Antennas
Supported 10

Number of Splitters Per Basestation 2

Connection Between Basestation
and Splitter 4-pair CAT5 cable with RJ-45

Connection Between Splitter and
Transceiver/Antennas 4-pair CAT5 cable with RJ-45

Powering of Splitter Locally powered via external power
supply

Transmission Method

Method of RF Operation	DECT standard, using two DECT bands per belt-pack for wider frequency response
Modulation	QPSK
Frequencies of Operation	1.881 – 1.897 GHz
RF Output	250 mW burst, average level 2 - 4 mW

Theory of Operation

Dynamic allocation of frequencies and handoff of belt-packs among the transceiver/antennas up to their individual limit of 5 connected belt-packs at a time; each belt-pack is assigned a “virtual port” within the FreeSpeak base station.

NOTICE ABOUT SPECIFICATIONS

While Clear-Com makes every attempt to maintain the accuracy of the information contained in its product manuals, that information is subject to change without notice. Performance specifications included in this manual are design-center specifications and are included for customer guidance and to facilitate system installation. Actual operating performance may vary.

13 GLOSSARY

Analog Port Any of the Eclipse matrix's analog input/output RJ-45 connectors that are used to connect cable from the matrix to panels and interfaces. Each "port" connects to a separate audio channel in the matrix intercom system.

Bus A bus is the channel or path between the components in the matrix along which electrical signals flow to carry information from one component to the next. In the Eclipse matrix the bus is located in the etched surface of the midplane.

Call Signal A call signal is an electronic signal sent from one panel or interface to another. A call signal can be audible and/or visual. Typically a call signal is sent to get the attention of a panel operator who may have turned down their intercom speaker's volume or removed their headset. It can also be sent to activate an electronic relay.

Category-5 cable EIA/TIA 568 category specification relating to network cabling. Shielded category-5 cabling is required for Eclipse matrix wiring.

CellCom Digital wireless communications product. Sold under the CellCom name in USA and as FreeSpeak in Europe and Asia.

Central Matrix The term "central matrix" is used to differentiate the central hardware and software of the intercom system from the connected audio devices. The central matrix consists of:

1. The metal housing for the circuit cards and power supplies.
2. The circuit cards.
3. The power supplies.
4. The rear panel connectors which connect the matrix's hardware to panels and interfaces.

Destination A device such as an intercom panel, beltpack, or interface to which audio signals are sent. The device from which audio signals are sent is called a "source".

Duplex All real-time communication between individuals talking face to face is full duplex, meaning that they can both talk and listen simultaneously. The Eclipse Omega matrix provides full-duplex audio.

ECS Eclipse Configuration System. Software program that guides the operation of the central matrix circuit cards and connected panels.

EMS Element Management System. Software program that is used to manage the Concert server system resources.

Ethernet International standard which describes how information is transmitted across a network. Provides for the efficient organization of network components.

Fiber-optic Cable A fiber-optic cable consists of a glass core covered with a reflective material called “cladding” and several layers of buffer coating to protect the cable from the environment. A laser sends light pulses through the glass core to the other end of the cable.

FreeSpeak Digital wireless communications product. Sold under the FreeSpeak name in Europe and Asia and CellCom in USA.

Full Duplex Refers to transmission of signals in two directions simultaneously.

IFB “Interruptible Foldback”. The term “foldback” refers to sending “program” audio, or some other audio mix, back to announcers while they are on the air. Doing so allows announcers to monitor themselves, other announcers, videotapes of commercials, or some mix of sources, while they on the air. This is typically found in television news and live broadcast events.

Announcers typically wear a small ear piece so they can hear the selected foldback audio mix. When a director wants to give directions to an announcer on air, or to announce changes in the program, the director must “interrupt” the foldback. To do this, the director uses a channel specifically set up to interrupt the foldback audio.

Interface Module A piece of electronic hardware designed to convert the 4-wire signals of a central matrix port to some other form of communication, such as 2-wire party line, telephone, etc. The interface module is connected to a central matrix port. The external non-4-wire device is then connected to the interface module.

ISO The ISO function, short for “panel ISolation”, allows a panel operator to call a destination and interrupt all of that destination’s other audio paths and establish a private conversation. When the call is completed the destination’s audio pathways are restored to their original state before the interruption.

IV-R Instant Voice Router. Software that routes digital audio data between Concert users and between Concert users and Eclipse systems.

Label A label is an alphanumeric name of up to five characters that identifies a source, destination, or control function accessed by an intercom panel. Labels appear in the displays of the intercom panel. Labels can identify panels, ports interfaced to other external equipment, fixed groups, party lines, and special control functions.

Mode A term used to describe a light path through a fiber as in multimode or single mode.

Multimode Fiber-optic Cable The glass core of a multimode fiber is larger than the core of a single mode fiber, which causes the transmitted light beam to disperse as it travels through the core. Single mode fiber, with its smaller core, concentrates the light beam so that it carries signals further. Multimode fiber was the first type of fiber offered

by manufacturers. Single-mode fiber evolved as production methods improved.

Multiplexing The process by which two or more signals are transmitted over a single communications channel. Examples include time division and wavelength division multiplexing.

Nanometer (nm) Common unit of measure for wavelength. One billionth of a meter.

Non-volatile Memory Data stored in the CPU's firmware (ROM) that is not lost when the power is turned off.

Optical Signal A laser at one end of a fiber-optic cable pulses on or off to send a light signal through the glass core of the cable to the other end of the cable. Because the light signals are binary (on or off), the signal is digital.

Panel Also referred to as "station" in some cases (usually older manuals). Any intelligent intercom device connected to the rear-panel analog ports of the central matrix. This term does not refer to devices connected through interface modules.

Port Any of the input/output connections (RJ-45 connectors) on the back panel of the central matrix. These connectors and the attached cables connect the central matrix to remote intercom devices. The term "port" emphasizes that the connection is a "portal" between the central matrix and the remote intercom devices.

Program Any separate audio source that is fed into the intercom channels. In television applications, for example, "program" audio is the audio that is broadcast on air.

Rack Unit or RU Standardized unit of mounting space on a rack panel. Each rack unit is 1.75 inches (44.45 mm) of vertical mounting space. Therefore 1 RU is 1.75 inches (44.45 mm) of vertical mounting space, 2 RU is 3.5 inches (88.9 mm), 3 RU is 5.25 inches (133.35 mm), and so on.

Remote Panel Any intelligent intercom device connected to the back-panel ports of the central matrix. This term does not refer to devices connected through interfaces.

Sidetone The sound of the panel operator's own voice heard in their own earphone as they speak.

Single-mode Fiber-optic Cable The glass core of a single-mode fiber is smaller in diameter than the core of a multimode fiber, so that the light signal transmitted over the core is more concentrated than with multimode fiber, which allows the signal to travel further. Single-mode fiber evolved from multimode fiber as production methods improved.

Source In this manual, the term "source" refers to a device—such as an intercom panel, interface, or beltpack—that sends audio into the matrix. The device to which audio is sent is called a "destination".

VOX In the Eclipse system, when audio at a panel exceeds a threshold, a light switches on at the panel's port card to visually cue the operator. The threshold level is set in the Eclipse Configuration Software.

V-Series Communications panels used with Eclipse systems providing advanced facilities. Available in rack mount and desktop formats.

Wavelength-division Multiplexing (WDM) A method of multiplexing optical signals developed for use on fiber-optic cable. Each signal is assigned a particular wavelength on the light spectrum and therefore many signals can be transmitted simultaneously without interfering with each other.

A

APPENDIX A: DECT CARRIER FREQUENCY CHART

RFC	CARRIER FREQUENCY	RFC	CARRIER FREQUENCY
0	1897.344	17	1911.168
1	1895.616	18	1912.896
2	1893.888	19	1914.624
3	1892.160	20	1916.352
4	1890.432	21	1918.080
5	1888.704	22	1919.808
6	1886.976	23*	1921.536
7	1885.248	24*	1923.264
8	1883.520	25*	1924.992
9	1881.972	26*	1926.720
10	1899.072	27*	1928.448
11	1900.800	28	1930.176
12	1902.528	29	1931.904
13	1904.256	30	1933.632
14	1905.984	31	
15	1907.712	32	
16	1909.440		

Table A-1: DECT Carrier Frequency Chart

*** Carriers 23 through 27 are those used in the USA.**

B

APPENDIX B: PROGRAMMING MENUS

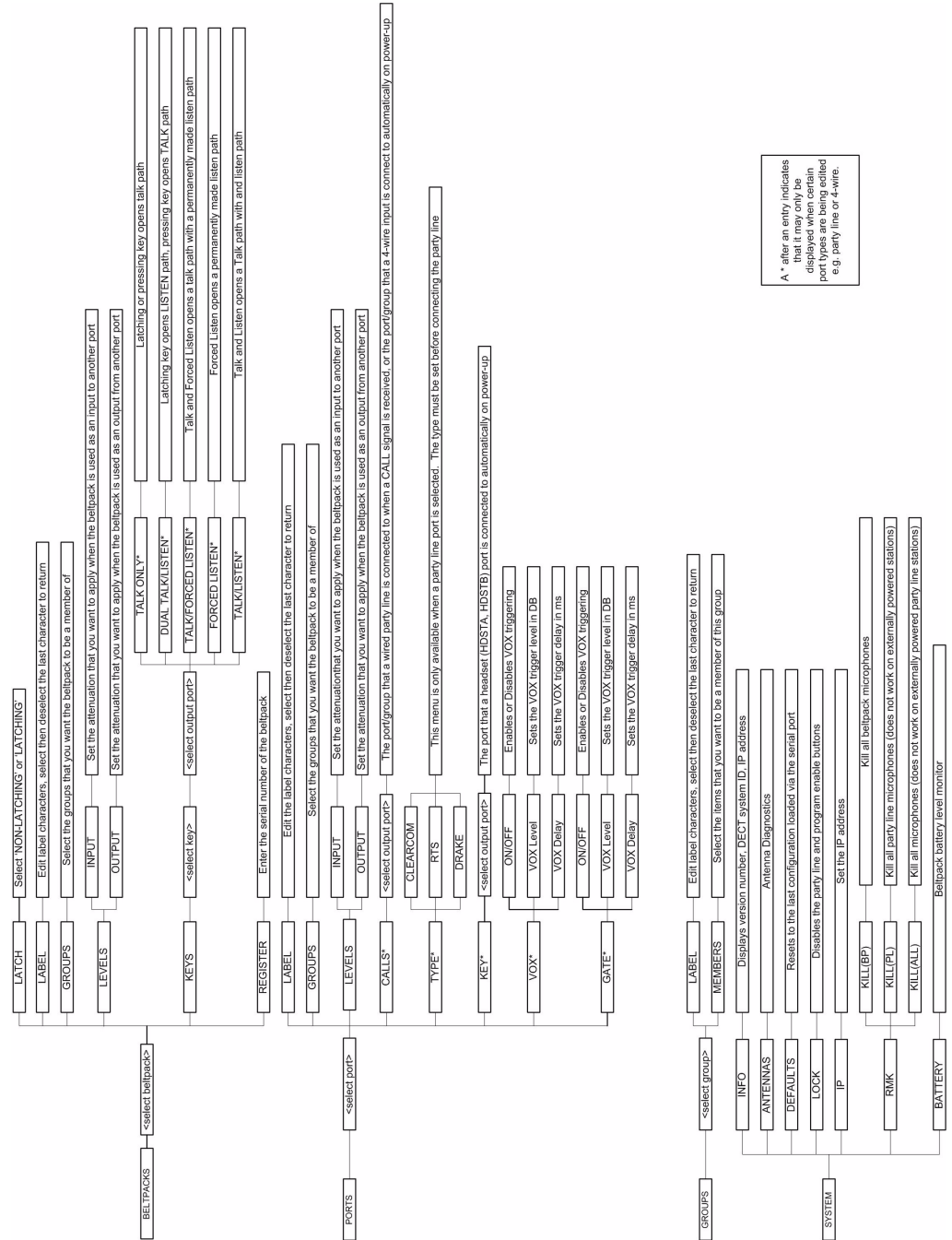

Figure B-1: Programming Menus

LIMITED WARRANTY

This document details the Clear-Com Standard Limited Warranty for all new products for sale within all regions with the exception of Military, Aerospace, and Government (MAG).

EXCEPT AS SET FORTH HEREIN ("LIMITED WARRANTY"), CLEAR-COM MAKES NO OTHER WARRANTIES, EXPRESS, IMPLIED OR STATUTORY, INCLUDING WITHOUT LIMITATION ANY WARRANTIES OF MERCHANTABILITY, NONINFRINGEMENT OF THIRD PARTY RIGHTS, OR FITNESS FOR A PARTICULAR PURPOSE, ALL OF WHICH ARE EXPRESSLY DISCLAIMED.

1. **Standard Limited Warranty.** Clear-Com Communication Systems ("Clear-Com") warrants its products, including supplied accessories, against defects in material or workmanship for the time periods as set forth below provided it was purchased from an authorized Clear-Com dealer or distributor.

a) Pursuant to this Limited Warranty, Clear-Com will, at its option:

- i) repair the product using new or refurbished parts, or;
- ii) replace the product with a new or refurbished product.

b) Remedies: In the event of a defect, the rights detailed in 1 (a) are your exclusive remedies. For purposes of this Limited Warranty, "refurbished" means a product or part that has been returned to its original specifications.

c) Standard Warranty Period (by Product):

- i) All Clear-Com brand systems and products, including belt packs, have a Limited Warranty of two years, with the exception of:
 - (1) Cables, accessories, components & consumable items have a Limited Warranty of 90 days.
 - (2) Any Clear-Com product that has been classified as obsolete at the time of sale has a Limited Warranty of 90 days from sales and will be replaced with the same product or a sales credit will be issued, at the sole discretion of Clear-Com.
 - (3) Headsets, handsets, microphones, and associated spare parts, as well as UHF wireless IFB products, have a Limited Warranty of one year.
 - (4) UHF WBS Analog wireless intercom systems have a Limited Warranty of three years.

(5) All software products, including Concert (Client and Server), ECS, Production Maestro and Logic Maestro are warranted for one year and shall substantially conform to published specifications. The media on which the Software is furnished is warranted to be free of defects in material and workmanship (under normal use) for a period of one year.

(6) Any Clear-Com products that are listed within the last time buy period have the same Limited Warranty for their type 1.i.1 - 1.i.5 as above.

d) Any Clear-Com product that is repaired or supplied as a replacement under the terms of this Limited Warranty shall inherit the remaining warranty period from the original product.

e) Standard Warranty Period Start Date

i) Dealer / Distributor Sales: In view of Dealer or Distributor stocking practices, the Standard Warranty Period for products sold through Dealers or Distributors will commence from the Clear-Com invoice date and will include an automatic extension of three months. Any valid warranty claim within the Standard Warranty Period as determined by the Clear-Com invoice date will be covered without further supporting evidence. All warranty claims after this date must be supported by the Customer's proof of purchase that demonstrates the product is still within the Standard Warranty Period (as detailed in Section 1.c.i above, plus the automatic three month extension) from their purchase date.

ii) Direct Sales: The Standard Warranty Period will commence from the date the product was shipped from Clear-Com to the Customer. The Standard Warranty Period start date for contracts that include commissioning will be the date of the Site Acceptance Test (SAT) or one month from conclusion of the commissioning project, whichever is earlier.

f) Invalidation of Warranty

i) This Limited Warranty shall be invalidated if the product's outer case has been opened and internal modifications have been made or damage has occurred, or upon the occurrence of other damage or failure not attributable to normal wear and tear. Authorized modifications with Clear-Com's express written permission will not invalidate the warranty.

g) Software Updates

i) Software Updates are released periodically to correct discovered program bugs. During the Warranty Period, software updates are available to Customers free of charge.

h) Software Upgrades

- i) Software Upgrades include new Features and/or Functional Enhancements and are not included as part of the Standard Warranty but may be purchased at the published rates.
- ii) Note: In the absence of a Software Update containing a program correction and no available workaround to mitigate the problem, at the discretion of Service, Sales, Engineering, or Product Management, the Customer may be provided a Software Upgrade under warranty.

2. **Exclusions.** Services do not cover damage or failure caused by any occurrence beyond Clear-Com's reasonable control, including without limitation acts of God, fire, flooding, earthquake, lightning, failure of electric power or air conditioning, neglect, misuse, improper operation, war, government regulations, supply shortages, riots, sabotage, terrorism, unauthorized modifications or repair, strikes, labor disputes or any product failure that Clear-Com determines is not a result of failure in the Services provided by Clear-Com. Further Services excluded from this Agreement include: services required due to errors or omissions in Customer purchase orders; installation or maintenance of wiring, circuits, electrical conduits or devices external to the products; replacement or reconditioning of products which, in Clear-Com's opinion cannot be reliably maintained or properly serviced due to excessive wear or deterioration; Customer's failure to maintain the installation site in accordance with the environmental specifications of the products; or service on products removed from the location originally specified by Customer and/or reinstalled without the prior written approval of Clear-Com. Customer will pay Clear-Com's then current published charges to restore such Covered Products to a condition eligible for further service under this Agreement. Clear-Com shall be excused from and shall not be liable for any failure or delay in performance under this Agreement due to the foregoing or any causes beyond its reasonable control.

3. **Limitation of Liability.** IN NO EVENT WILL CLEAR-COM BE LIABLE UNDER THIS AGREEMENT FOR ANY INDIRECT, SPECIAL, INCIDENTAL OR CONSEQUENTIAL DAMAGES (INCLUDING WITHOUT LIMITATION LOST PROFITS), REGARDLESS OF THE FORM OF ACTION, EVEN IF ADVISED IN ADVANCE OF THE POSSIBILITY OF SUCH DAMAGES.

4. **Assignment.** Neither party may assign this Agreement or any portion thereof without the prior written consent of the other, except in the event of a merger, sale of all or substantially all of the assets or other corporate reorganization.

5. **Ownership of replaced parts or product.** All replaced parts or products become the property of Clear-Com.

6. **Entire Agreement.** This Agreement constitutes the entire agreement between the parties with respect to the subject matter hereof, and supersedes all prior or contemporaneous proposals, oral or written, and all other communications between them relating to the subject matter of this Agreement.

TECHNICAL SUPPORT & REPAIR POLICY

NOVEMBER 1, 2008

In order to ensure that your experience with Clear-Com and our World Class products is as beneficial, effective and efficient as possible, we would like to define the policies and share some "best practices" that can accelerate any problem solving processes which we may find necessary and to enhance your customer service experience. Our Technical Support, Return Material Authorization, and Repair Policies are set forth below. These Policies are subject to revision and constantly evolve in order to address our Customers' and the Market's needs. Accordingly these are provided by way of guidance and for information only and may be changed at anytime with or without Notice.

TECHNICAL SUPPORT POLICY

a) Telephone, online, and e-mail technical support will be provided by the Customer Service Center free of charge during the Warranty Period.

b) Technical support will be provided free of charge for all software products under the following conditions:

i) The application, operating, and embedded software is installed on a product covered by Clear-Com's Limited Warranty, and:

(1) The software is at the current release level; or,

(2) The software is one (1) version removed from current.

ii) Older versions of software will receive "best-effort" support, but will not be updated to correct reported bugs or add requested functionality.

c) For Technical Support:

i) North and South America, (inc. Canada, Mexico, and the Caribbean) & US Military:

Hours: 0800 - 1700 Pacific Time

Days: Monday - Friday

Tel: +1 510 337 6600

Email: CustomerServicesUS@vitecgroup.com

ii) Europe, the Middle East and Africa:

Hours: 0800 - midnight Central European Time

Days: Monday - Friday
Tel: +49 40 853 999 700
Email: TechnicalSupportEMEA@vitecgroup.com

iii) Asia-Pacific:
Hours: 0800 - 1700 Pacific Time
Days: Monday - Friday
Tel: +1 510 337 6600
Email: CustomerServicesAPAC@vitecgroup.com

d) Email Technical Support is available for all Clear-Com branded products free of charge for the life of the product, or two years after a product has been classified as obsolete, whichever comes first.

e) Support for Distributor and Dealer Sales

i) Distributors and Dealers may utilize the Customer Service Centers once a system has been installed and commissioned. Clear-Com Systems and Applications Engineers will provide support to the Distributor from the pre-sales stage through to satisfactory installation for new system purchases. Customers will be encouraged to contact their Dealer or Distributor with their installation and technical support enquires rather than using the Customer Service Centers directly.

f) Support for Direct Sales

i) Customers may utilize the Customer Service Centers once a system has been installed and commissioned by Clear-Com Systems and Applications Engineers, or in the case of project installations, once the Project Team has completed the hand-over to the Support Centers.

RETURN MATERIAL AUTHORIZATION POLICY

a) Authorizations: All products returned to Clear-Com or a Clear-Com Authorized Service Partner must be identified by a Return Material Authorization (RMA) number.

b) The Customer will be provided with an RMA number upon contacting Clear-Com Sales Support as instructed below.

c) The RMA number must be obtained from Clear-Com via phone or email prior to returning product to the Service Center. Product received by the Service Center without a proper RMA number is subject to return to the Customer at the Customer's expense.

d) Damaged equipment will be repaired at the Customer's expense.

e) Returns are subject to a 15% restocking fee.

f) Advance Warranty Replacements (AWRs);

- i) *During the first 30 days of the Standard Warranty Period:* Once the equipment fault has been verified by Clear-Com or its authorized representative, Clear-Com will ship a new replacement product. The Customer will be provided with an RMA number and be required to return the faulty equipment within 14 days of receipt of the replacement or will be invoiced for the list price of a new product.
- ii) *During days 31-90 of the Standard Warranty Period:* Once the equipment fault has been verified by Clear-Com or its authorized representative, Clear-Com will ship a like-new, fully refurbished replacement product. The Customer will be provided with an RMA number and be required to return the faulty equipment within 14 days of receipt of the replacement or will be invoiced for the list price of a new product.
- iii) To obtain an RMA number or request an AWR:

(1) North and South America, Asia-Pacific, and US Military:

Hours: 0800 - 1700 Pacific Time
Days: Monday - Friday
Tel: +1 510 337 6600
Email: SalesSupportUS@vitecgroup.com

(2) Europe, the Middle East and Africa:

Hours: 0800 - 1700 GMT + 1
Days: Monday - Friday
Tel: + 44 1223 815000
Email: SalesSupportEMEA@vitecgroup.com

- iv) Note: AWRs are not available for UHF WBS Analog wireless intercom systems. UHF WBS Analog wireless intercom systems out-of-box failures must be returned to Alameda for repair.
- v) Note: Out-of-box failures returned after 90 days will be repaired and not replaced unless approved by Clear-Com Management.
- vi) Note: AWRs are not available after 90 days of receipt of product unless an AWR Warranty Extension is purchased at the time of product purchase.

- vii) Note: Shipping charges, including duties, taxes, and insurance (optional), to Clear-Com's factory is the responsibility of the Customer. Shipping AWRs from Clear-Com is at Clear-Com's expense (normal ground or international economy delivery). Requests for expedited shipping (E.g. "Next-Day Air") and insurance are the responsibility of the Customer.

REPAIR POLICY

- a) Repair Authorizations: All products sent to Clear-Com or a Clear-Com Authorized Service Partner for repair must be identified by a Repair Authorization (RA) number (see above).
- b) The Customer will be provided with an RA number upon contacting Clear-Com Customer Services as instructed below.
- c) The RA number must be obtained from Clear-Com via phone or email prior to returning product to the Service Center. Product received by the Service Center without a proper RA number is subject to return to the Customer at the Customer's expense.
- d) Return for Repair
 - i) Customers are required to ship equipment at their own cost (including transportation, packing, transit, insurance, taxes and duties) to Clear-Com's designated location for repair.
 - (1) Clear-Com will pay for the equipment to be returned to the Customer when it is repaired under warranty.
 - (2) Shipping from Clear-Com is normal ground delivery or international economy. Requests for expedited shipping (E.g. "Next-Day Air") and insurance are the responsibility of the Customer.
 - ii) **Clear-Com does not provide temporary replacement equipment ("loaner") during the period the product is at the factory for repair.** Customers should consider a potential prolonged outage during the repair cycle, and if required for continuous operations purchase minimum spare equipment required or purchase an AWR Warranty Extension.
 - iii) No individual parts or subassemblies will be provided under warranty, and warranty repairs will be completed only by Clear-Com or its Authorized Service Partners.
 - iv) Customers requesting a non-warranty repair will be provided an estimate of the total repair cost prior to the return of the equipment. In the event that Clear-Com is unable to estimate

the cost of repair, the Customer may elect to return the product to the factory for an estimate. The Customer is responsible for shipping costs both to and from the factory in the event they choose not to accept the estimate.

v) The Customer must provide either a purchase order for the repair work, or will be required to make an advance payment (as a debit against the Dealer's line of credit, or credit card) prior to the repaired product being returned to the Customer.

vi) For requesting a Repair Authorization number:

(1) North and South America, Asia-Pacific, and US Military:

Hours: 0800 - 1700 Pacific Time
Days: Monday - Friday
Tel: +1 510 337 6600
Email: CustomerServicesUS@vitecgroup.com

(2) Europe, the Middle East and Africa:

Hours: 0800 - midnight Central European Time
Days: Monday - Friday
Tel: +49 40 853 999 700
Email: TechnicalSupportEMEA@vitecgroup.com

vii) Note: Clear-Com's Limited Warranty does not cover normal wear and tear. The Customer will be charged the full cost of the repair if their equipment has been tampered with by non-approved personnel, or has been subject to damage through electrical failure, liquid damage or mishandling. The Customer Service Center will provide the Customer with a cost estimate for any such repairs prior to undertaking the work.