

Canon

EOS 7D



Canon EOS 7D

INSTRUCTION MANUAL 

E

INSTRUCTION
MANUAL

Thank you for purchasing a Canon product.

The EOS 7D is a high-performance, digital SLR camera featuring a fine-detail CMOS sensor with about 18.0 effective megapixels, Dual “DIGIC 4”, 100% viewfinder coverage, high-precision and high-speed 19-point AF (all cross-type), approx. 8 fps continuous shooting, Live View shooting, and Full HD (Full High-Definition) movie shooting. The camera is highly responsive to any shooting situation at anytime, provides many features for demanding shoots, and expands shooting possibilities with system accessories.

Take a Few Test Shots to Familiarize Yourself with the Camera

With a digital camera, you can immediately view the image you have captured. While reading this manual, take a few test shots and see how they come out. You can then better understand the camera.

To avoid botched pictures and accidents, first read the Safety Warnings (p.261,262) and Handling Precautions (p.12,13).

Testing the Camera Before Using and Liability

After shooting, playback and check whether the image has been properly recorded. If the camera or memory card is faulty and the images cannot be recorded or downloaded to a computer, Canon cannot be held liable for any loss or inconvenience caused.

Copyrights

Copyright laws in your country may prohibit the use of your recorded images of people and certain subjects for anything but private enjoyment. Also be aware that certain public performances, exhibitions, etc., may prohibit photography even for private enjoyment.

CF Card

In this manual, “card” refers to the CF card. **The CF card (for recording images) is not included.** Please purchase it separately.

Item Check List

Before starting, check that all the following items have been included with your camera. If anything is missing, contact your dealer.

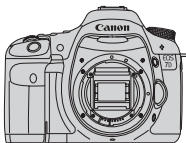

Camera
(with eyecup and
body cap)



**Battery Pack
LP-E6**
(with protective cover)



**Battery Charger
LC-E6/LC-E6E***



**Wide Strap
EW-EOS7D**



**Interface Cable
IFC-200U**

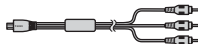

**Stereo AV Cable
AVC-DC400ST**



**EOS DIGITAL
Solution Disk**
(Software)



**Software
Instruction Manual**

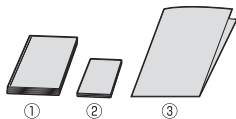

(1) **Instruction Manual** (this booklet)

(2) **Pocket Guide**

Quick start guide to shooting.

(3) **CD-ROM Guide**









Guide to the provided software (EOS DIGITAL Solution Disk) and Software Instruction Manuals.

* Battery Charger LC-E6 or LC-E6E is provided. (The LC-E6E comes with a power cord.)

- If you purchased a Lens Kit, check that the lens is included.
- Depending on the Lens Kit type, the lens instruction manual might also be included.
- Be careful not to lose any of the above items.

Conventions Used in this Manual

Icons in this Manual

-  : Indicates the Main Dial.
-  : Indicates the Quick Control Dial.
-  : Indicates the Multi-controller.
-  : Indicates the setting button.
- , , ,  : Indicates that the respective function remains active for 4 sec., 6 sec., 10 sec., or 16 sec. respectively after you let go of the button.

* In this manual, the icons and markings indicating the camera's buttons, dials, and settings correspond to the icons and markings on the camera and on the LCD monitor.

MENU : Indicates a function which can be changed by pressing the <MENU> button and changing the setting.

☆ : When shown on the upper right of the page, it indicates that the function is available only when the Mode Dial is set to **P**, **Tv**, **Av**, **M**, or **B**.

* Function which cannot be used in the fully-automatic modes (/CA).

(p.**): Reference page numbers for more information.

 : Tip or advice for better shooting.

 : Problem-solving advice.

 : Warning to prevent shooting problems.

 : Supplemental information.

Basic Assumptions

- All operations explained in this manual assume that the power switch is already set to <ON> (p.27).
- <> operations explained in this manual assume that the Quick Control Dial switch is already set to <∟>.
- It is assumed that all the menu settings and Custom Functions are set to the default.
- For explanatory purposes, the instructions show the camera attached with an EF-S15-85mm f/3.5-5.6 IS USM lens.

Chapters

For first-time DSLR users, Chapters 1 and 2 explain the camera's basic operations and shooting procedures.

	Introduction Camera basics.	2
1	Getting Started	23
2	Basic Shooting Fully automatic shooting.	49
3	Image Settings	57
4	Setting the AF and Drive Modes	83
5	Advanced Operations Advanced shooting features.	95
6	Live View shooting Shoot while viewing the LCD monitor.	131
7	Shooting Movies	149
8	Image Playback	161
9	Sensor Cleaning	183
10	Printing Images	189
11	Customizing the Camera	203
12	Reference	227

Contents

Introduction

Item Check List.....	3
Conventions Used in this Manual	4
Chapters	5
Index to Features	10
Handling Precautions	12
Quick Start Guide	14
Nomenclature	16

1 Getting Started 23







Charging the Battery	24
Installing and Removing the Battery.....	26
Turning on the Power	27
Installing and Removing the CF Card.....	29
Attaching and Detaching a Lens	31
About the Lens Image Stabilizer.....	33
Basic Operation	34
[Q] Using the Quick Control Screen	38
[MENU] Menu Operations	40
Before You Start	42
Setting the Interface Language	42
Setting the Date and Time	42
Formatting the Card	43
Set the Power-off Time/Auto Power Off	44
Reverting the Camera to the Default Settings.....	45
Displaying the Grid and Electronic Level.....	47

2 Basic Shooting 49



<input type="checkbox"/> Fully Automatic Shooting	50
<input type="checkbox"/> Full Auto Techniques	52
[CA] Creative Auto Shooting	53
Setting the Image Review Time	56

3 Image Settings 57





Setting the Image-recording Quality.....	58
ISO: Setting the ISO Speed	62

 Selecting a Picture Style	64
 Customizing a Picture Style	66
 Registering a Picture Style.....	68
WB : Setting the White Balance	70
 Custom White Balance	71
 Setting the Color Temperature	72
 White Balance Correction	73
Auto Lighting Optimizer	75
Lens Peripheral Illumination Correction	76
Creating and Selecting a Folder.....	78
File Numbering Methods	80
Setting the Color Space	82

4 Setting the AF and Drive Modes 83

AF: Selecting the AF Mode.....	84
 Selecting the AF Area	87
AF Area Selection Modes	89
When Autofocus Fails	92
MF: Manual Focusing	92
 Selecting the Drive Mode.....	93
 Using the Self-timer	94

5 Advanced Operations 95

P : Program AE.....	96
Tv : Shutter-Priority AE	98
Av : Aperture-Priority AE.....	100
Depth of Field Preview	101
M : Manual Exposure	102
 Selecting the Metering Mode	103
Setting Exposure Compensation.....	104
 Auto Exposure Bracketing (AEB)	105
 AE Lock	106
B : Bulb Exposures	107
Mirror Lockup	109
 Remote Control Shooting.....	110
 Using the Built-in Flash	111

Setting the Flash	115
Using Wireless Flash.....	119
External Speedlites	129











6 Live View Shooting 131

 Live View Shooting.....	132
Shooting Function Settings	135
 Menu Function Settings.....	136
Using AF to Focus.....	138
Focusing Manually.....	145

7 Shooting Movies 149

 Shooting Movies.....	150
Shooting Function Settings	155
 Menu Function Settings.....	156



8 Image Playback 161

 Image Playback.....	162
INFO. Shooting Information Display.....	163
  Searching for Images Quickly	165
 /  Magnified View.....	167
 Rotating the Image.....	168
 Enjoying Movies	169
 Playing Movies	171
 Editing the Movie's First and Last Scenes	173
Slide Show (Auto Playback).....	174
Viewing the Images on TV.....	176
 Protecting Images.....	178
 Erasing Images.....	179
Changing Image Playback Settings.....	181
Adjusting the LCD Monitor Brightness	181
Auto Rotation of Vertical Images	182

9 Sensor Cleaning 183

 Automatic Sensor Cleaning	184
Appending Dust Delete Data	185
Manual Sensor Cleaning	187

10 Printing Images 189

Preparing to Print	190
 Printing.....	192
Trimming the Image	197
 Digital Print Order Format (DPOF)	199
 Direct Printing with DPOF	202

11 Customizing the Camera 203

Setting Custom Functions	204
Custom Functions	205
Custom Function Settings	206
C.Fn I : Exposure	206
C.Fn II : Image	208
C.Fn III : Autofocus/Drive	209
C.Fn IV : Operation/Others	215
Registering My Menu	222
 Register Camera User Settings.....	223
Setting Copyright Information.....	225

12 Reference 227

INFO. Button Functions.....	228
Checking the Battery Information	230
Using a Household Power Outlet	234
Replacing the Date/Time Battery	235
Function Availability Table	236
Menu Settings	238
Troubleshooting Guide.....	243
Error Codes.....	249
System Map	250
Specifications	252
Safety Warnings.....	261
Index	270

Index to Features

Power

- **Battery**
 - Charging → p.24
 - Battery check → p.28
 - Battery information check → p.230
- **Power outlet** → p.234
- **Auto power off** → p.44

Lens

- **Attaching/Detaching** → p.31
- **Zoom** → p.32
- **Image Stabilizer** → p.33

Basic Settings (Menu Functions)

- **Language** → p.42
- **Date/Time** → p.42
- **LCD brightness adjustment** → p.181
- **Beeper** → p.238
- **Release shutter without card** → p.29

Recording Images

- **Format** → p.43
- **Create/select a folder** → p.78
- **File No.** → p.80

Image Quality

- **Image-recording quality** → p.58
- **One-touch RAW+JPEG** → p.61
- **ISO speed** → p.62
- **Picture Style** → p.64
- **White balance** → p.70

- **Color space** → p.82
- **Image improvement features**
 - Auto Lighting Optimizer → p.75
 - Lens peripheral illumination correction → p.76
 - Noise reduction for long exposures → p.208
 - Noise reduction for high ISO speeds → p.208
 - Highlight tone priority → p.209

AF

- **AF mode** → p.84
- **AF point selection** → p.87
- **AF area selection mode** → p.89
 - Limited → p.212
- **Manual focusing** → p.92

Metering

- **Metering mode** → p.103

Drive

- **Drive modes** → p.93
- **Maximum burst** → p.60

Shooting

- **Electronic level** → p.48
- **Creative Auto** → p.53
- **Program AE** → p.96
- **Shutter-priority AE** → p.98
- **Aperture-priority AE** → p.100
- **Manual exposure** → p.102
- **Bulb** → p.107
- **Mirror lockup** → p.109
- **Quick Control screen** → p.38

- Self-timer → p.94
- Remote control → p.110

Exposure adjustment

- Exposure compensation → p.104
- AEB → p.105
- AE lock → p.106

Flash

- Built-in flash → p.111
 - Flash exposure compensation → p.113
 - FE lock → p.114
- External flash → p.129
- Flash control → p.115
 - Wireless flash → p.119

Live View shooting

- Live View shooting → p.131
- AF → p.138
- Manual focusing → p.145
- Exposure simulation → p.136
- Grid display → p.136
- Silent shooting → p.137

Movie shooting

- Movie shooting → p.149
- Movie menu → p.156
- Stills → p.154

Image playback

- Image review time → p.56
- Single image display → p.162
 - Shooting information display → p.163
- Movie playback → p.171
- Movie first/last scene editing → p.173
- Index display → p.165
- Image browsing (Jump display) → p.166
- Magnified view → p.167
- Auto playback → p.174
- Viewing the images on TV → p.176
- Protect → p.178
- Erase → p.179

Customization

- Custom Function (C.Fn) → p.204
- Custom Controls → p.215
- My Menu → p.222
- Camera user setting registration → p.223

Sensor cleaning/ Dust reduction

- Sensor cleaning → p.183
- Add Dust Delete Data → p.185

Viewfinder

- Dioptic adjustment → p.34
- Grid display → p.47
- Electronic level → p.221

Handling Precautions

Camera Care

- This camera is a precision instrument. Do not drop it or subject it to physical shock.
- The camera is not waterproof and cannot be used underwater. If you accidentally drop the camera into water, promptly consult your nearest Canon Service Center. Wipe off any water droplets with a dry cloth. If the camera has been exposed to salty air, wipe it with a well-wrung wet cloth.
- Never leave the camera near anything having a strong magnetic field such as a magnet or electric motor. Also avoid using or leaving the camera near anything emitting strong radio waves such as a large antenna. Strong magnetic fields can cause camera misoperation or destroy image data.
- Do not leave the camera in excessive heat such as in a car in direct sunlight. High temperatures can cause the camera to malfunction.
- The camera contains precision electronic circuitry. Never attempt to disassemble the camera yourself.
- Use a blower to blow away dust on the lens, viewfinder, reflex mirror, and focusing screen. Do not use cleaners that contain organic solvents to clean the camera body or lens. For stubborn dirt, take the camera to the nearest Canon Service Center.
- Do not touch the camera's electrical contacts with your fingers. This is to prevent the contacts from corroding. Corroded contacts can cause camera misoperation.
- If the camera is suddenly brought in from the cold into a warm room, condensation may form on the camera and internal parts. To prevent condensation, first put the camera in a sealed plastic bag and let it adjust to the warmer temperature before taking it out of the bag.
- If condensation forms on the camera, do not use the camera. This is to avoid damaging the camera. If there is condensation, remove the lens, card and battery from the camera, and wait until the condensation has evaporated before using the camera.
- If the camera will not be used for an extended period, remove the battery and store the camera in a cool, dry, well-ventilated location. Even while the camera is in storage, press the shutter button a few times once in a while to check that the camera is still working.
- Avoid storing the camera where there are corrosive chemicals such as a darkroom or chemical lab.
- If the camera has not been used for an extended period, test all its functions before using it. If you have not used the camera for some time or if there is an important shoot coming up, have the camera checked by your Canon dealer or check the camera yourself and make sure it is working properly.

LCD Panel and LCD Monitor

- Although the LCD monitor is manufactured with very high precision technology with over 99.99% effective pixels, there might be a few dead pixels among the remaining 0.01% or less pixels. Dead pixels displaying only black or red, etc., are not a malfunction. They do not affect the images recorded.
- If the LCD monitor is left on for a prolonged period, screen burn-in may occur where you see remnants of what was displayed. However, this is only temporary and will disappear when the camera is left unused for a few days.
- In low or high temperatures, the LCD monitor display may seem slow or it might look black. It will return to normal at room temperature.

Cards

To protect the card and its recorded data, note the following:

- Do not drop, bend, or wet the card. Do not subject it to excessive force, physical shock, or vibration.
- Do not store or use the card near anything having a strong magnetic field such as a TV set, speakers, or magnet. Also avoid places prone to having static electricity.
- Do not leave the card in direct sunlight or near a heat source.
- Store the card in a case.
- Do not store the card in hot, dusty, or humid locations.

Lens

After detaching the lens from the camera, attach the lens caps or put down the lens with the rear end up to avoid scratching the lens surface and electrical contacts.

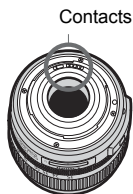

Cautions During Prolonged Use

If you use continuous shooting, Live View shooting, or movie shooting for a prolonged period, the camera may become hot. Although this is not a malfunction, holding the hot camera for a long period can cause slight skin burns.

Quick Start Guide

1

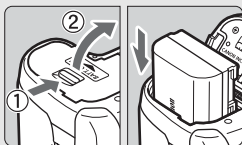

Insert the battery. (p.26)

To charge the battery, see page 24.

2

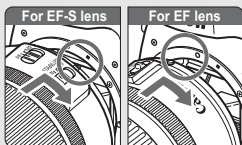

Attach the lens. (p.31)

When attaching an EF-S lens, align it with the white index on the camera.
For other lenses, align it with the red index.

3

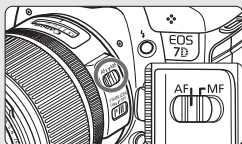

Set the lens focus mode switch to <AF>. (p.31)

4

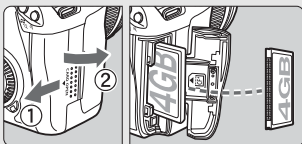

Open the slot cover and insert a card. (p.29)

Face the label side toward you and insert the end with the small holes into the camera.

5

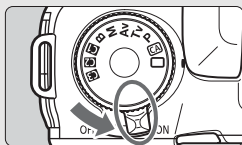

Set the power switch to <ON>. (p.27)

6

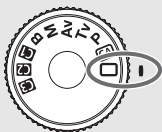

Set the Mode Dial to (Full Auto). (p.50)

All the necessary camera settings will be set automatically.

7



Focus the subject. (p.35)

Look through the viewfinder and aim the viewfinder center over the subject. Press the shutter button halfway, and the camera will focus the subject. If necessary, the built-in flash will pop-up automatically.

8

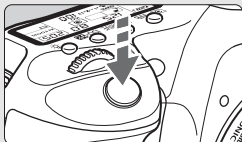

Take the picture. (p.35)

Press the shutter button completely to take the picture.

9



Review the picture. (p.56)

The captured image will be displayed for about 2 sec. on the LCD monitor. To display the image again, press the  button (p.162).

- To view the images captured so far, see “Image Playback” (p.162).
- To delete an image, see “Erasing Images” (p.179).

Nomenclature

For detailed information, reference page numbers are provided in parentheses (p.**).

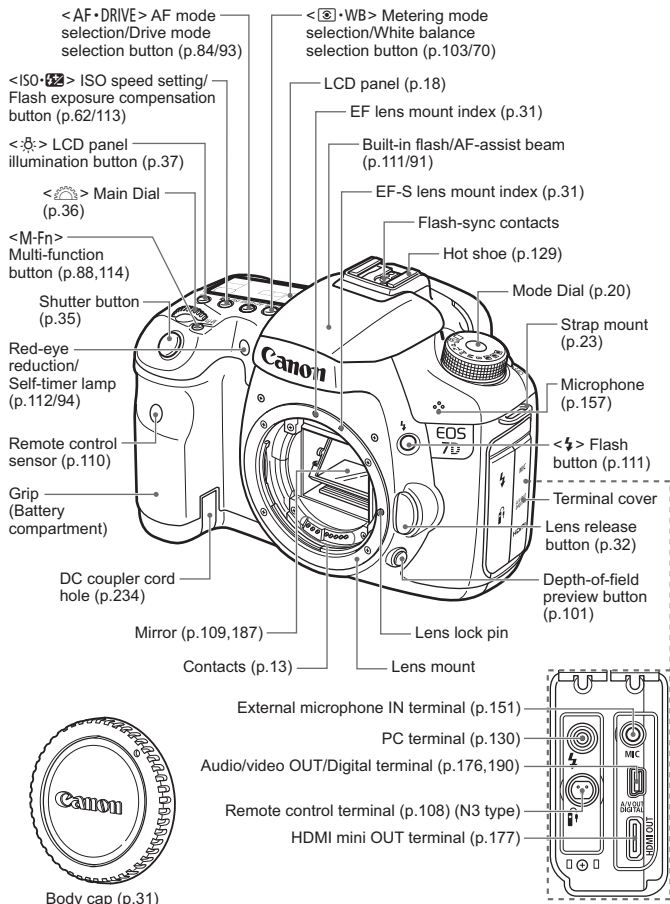

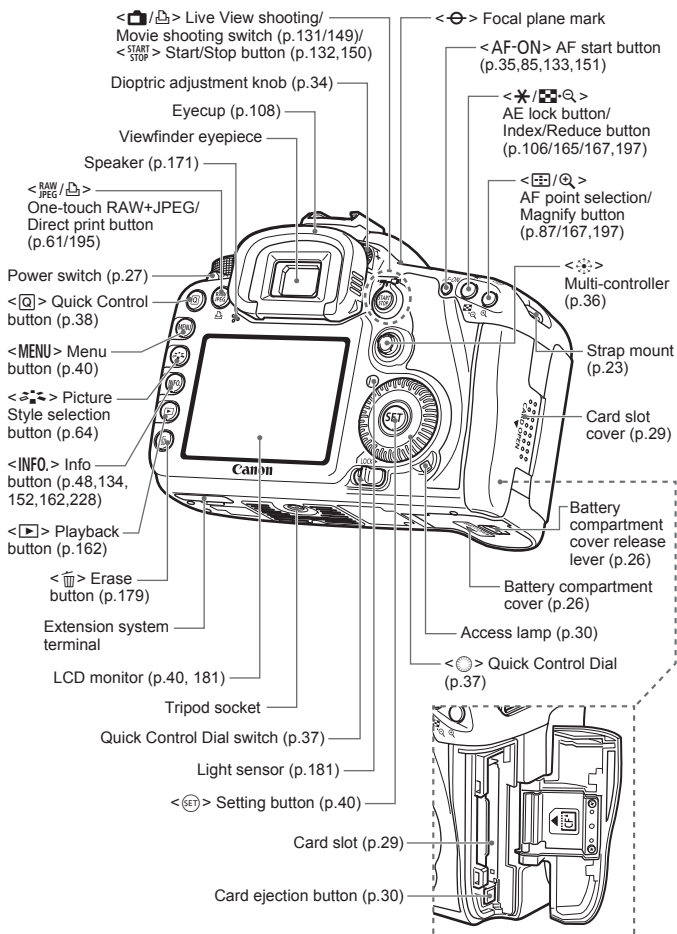

LCD Panel

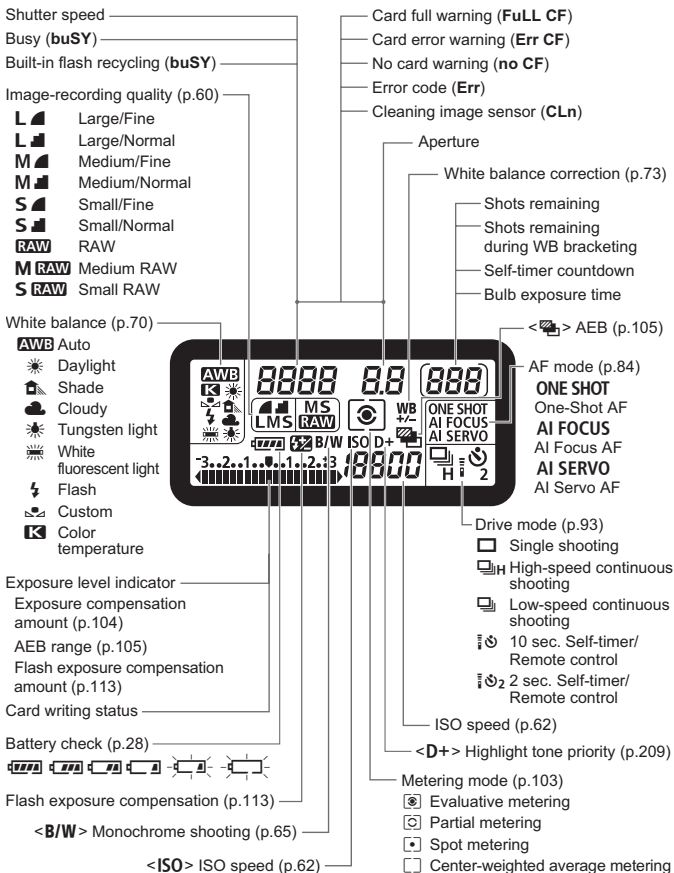

The display will show only the settings currently applied.

Viewfinder Information

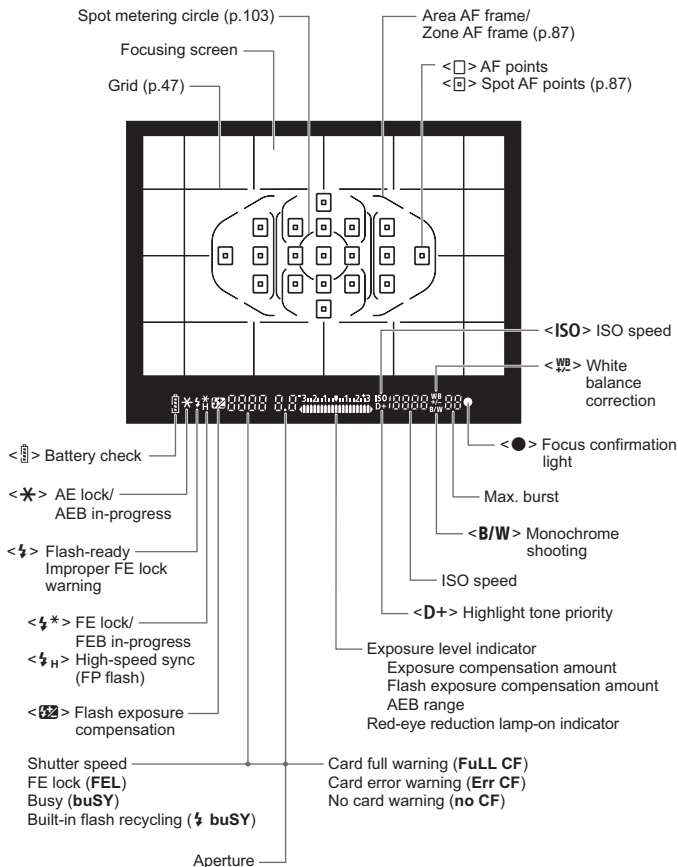

The display will show only the settings currently applied.

Mode Dial

Camera User Settings

Most camera settings can be registered under **[A]**, **[Q]**, or **[E]** (p.223).

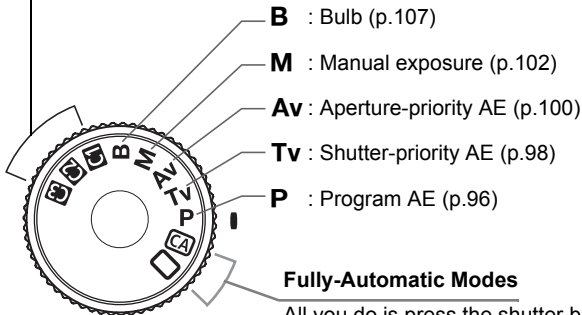

Fully-Automatic Modes

All you do is press the shutter button.
Fully-automatic shooting suitable for the subject.

[A] : Full Auto (p.50)

[CA] : Creative Auto (p.53)

Lens

Lens with a distance scale

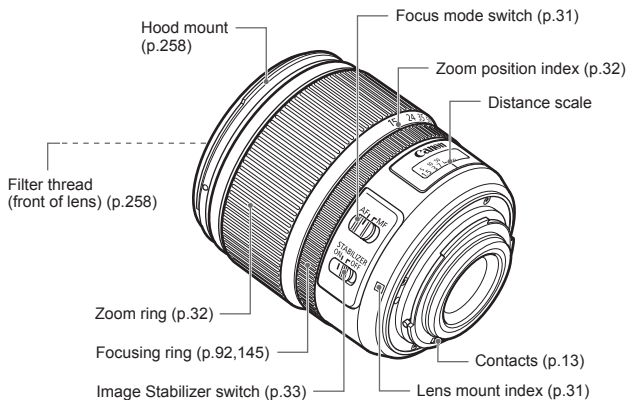

Lens without a distance scale

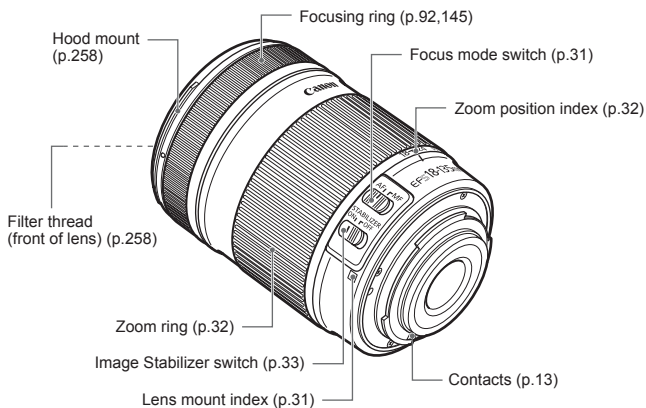

Battery Charger LC-E6

Charger for Battery Pack LP-E6 (p.24).

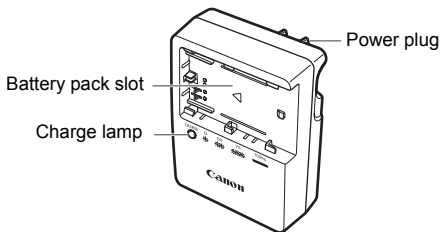

This power unit is intended to be correctly orientated in a vertical or floor mount position.

**IMPORTANT SAFETY INSTRUCTIONS-SAVE THESE INSTRUCTIONS.
DANGER-TO REDUCE THE RISK OF FIRE OR ELECTRIC SHOCK,
CAREFULLY FOLLOW THESE INSTRUCTIONS.**

For connection to a supply not in the U.S.A., use an attachment plug adapter of the proper configuration for the power outlet.

Battery Charger LC-E6E

Charger for Battery Pack LP-E6 (p.24).

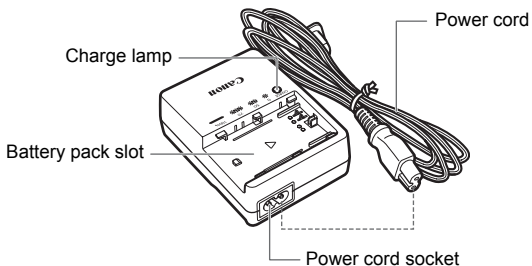

1

Getting Started

This chapter explains preparatory steps before you start shooting and basic camera operations.

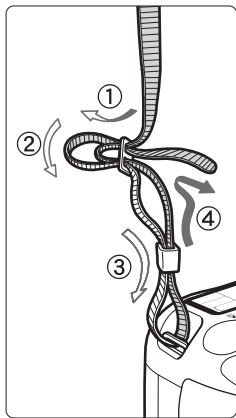

Attaching the Strap

Pass the end of the strap through the camera's strap mount eyelet from the bottom. Then pass it through the strap's buckle as shown in the illustration. Pull the strap to take up any slack and make sure the strap will not loosen from the buckle.

- The eyepiece cover is also attached to the strap (p.108).

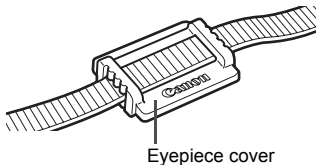

Charging the Battery

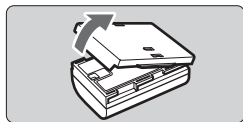

1 Remove the protective cover.

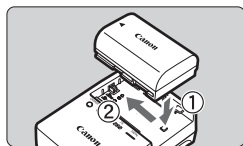

2 Attach the battery.

- As shown in the illustration, attach the battery securely.
- To detach the battery, follow the above procedure in reverse.

LC-E6

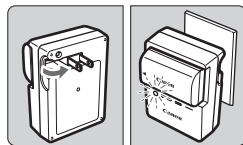

3 Recharge the battery.

For LC-E6

- As shown by the arrow, flip out the battery charger's prongs and insert the prongs into a power outlet.

LC-E6E

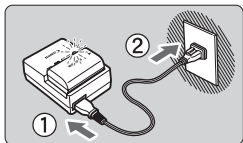

For LC-E6E

- Connect the power cord to the charger and insert the plug into the power outlet.
- ▶ Recharging starts automatically and the charge lamp blinks in orange.

Charge Level	Charge Lamp	
	Color	Indicator
0 - 50%	Orange	Blinks once per second
50 - 75%		Blinks twice per second
75% or higher		Blinks three times per second
Fully charged	Green	Lights on

- It takes about 2.5 hours to fully recharge a completely exhausted battery at 23°C / 73°F. The time required to recharge the battery depends on the ambient temperature and battery's charge level.
- For safety reasons, recharging in low temperatures (5°C - 10°C / 41°F - 50°F) will take a longer time (up to 4 hours).

Tips for Using the Battery and Charger

- **Recharge the battery on the day before or on the day it is to be used.**
Even during non-use or storage, a charged battery will gradually discharge and lose its power.

- **After recharging the battery, detach it and unplug the power cord or prongs from the power outlet.**

- **You can attach the cover in a different orientation to indicate whether the battery has been recharged or not.**

If the battery has been recharged, attach the cover so that the battery-shaped hole  is aligned over the blue sticker on the battery. If the battery is exhausted, attach the cover in the opposite orientation.

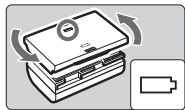

- **When not using the camera, remove the battery.**

If the battery is left in the camera for a prolonged period, a small amount of power current is released, resulting in excess discharge and shorter battery life. Store the battery with the protective cover attached. Storing the battery after it is fully charged can lower the battery's performance.

- **The battery charger can also be used in foreign countries.**

The battery charger is compatible with a 100 V AC to 240 V AC 50/60 Hz power source. If necessary, attach a commercially-available plug adapter for the respective country or region. Do not attach any portable voltage transformer to the battery charger. Doing so can damage the battery charger.

- **If the battery becomes exhausted quickly even after being fully charged, the battery has worn out.**

Check the battery's recharge performance (p.230) and purchase a new battery.



- If the battery's remaining capacity (p.230) is 94% or higher, the battery will not be recharged.
- After disconnecting the charger's power plug, do not touch the charger power plug (prongs) for at least 3 sec.

Installing and Removing the Battery

Installing the Battery

Load a fully charged Battery Pack LP-E6 into the camera. **The camera's viewfinder will become bright when a battery is installed, and darken when the battery is removed.**

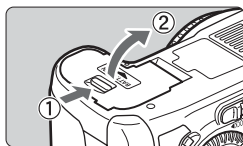

1 Open the battery compartment cover.

- Slide the lever as shown by the arrow and open the cover.

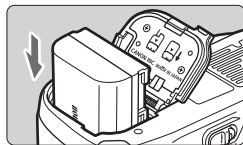

2 Insert the battery.

- Insert the end with the battery contacts.
- Insert the battery until it locks in place.

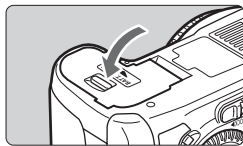

3 Close the cover.

- Press the cover to close it.

 Only the Battery Pack LP-E6 can be used.

Removing the Battery

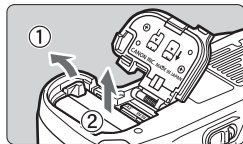

Open the cover and remove the battery.

- Press the battery release lever as shown by the arrow and remove the battery.
- To prevent short circuiting, be sure to attach the protective cover to the battery.

Turning on the Power

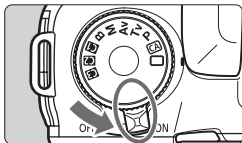

- <ON> : The camera turns on.
- <OFF> : The camera is turned off and does not operate. Set to this position when not using the camera.

About the Automatic Self-Cleaning Sensor

- Whenever you set the power switch to <ON> or <OFF>, the sensor cleaning will be executed automatically. During the sensor cleaning, the LCD monitor will display <□>. Even during the sensor cleaning, you can still shoot by pressing the shutter button halfway (p.35) to stop the sensor cleaning and take a picture.
- If you repeatedly turn the power switch <ON>/<OFF> at a short interval, the <□> icon might not be displayed. This is normal and not a problem.

About Auto Power Off

- To save battery power, the camera turns off automatically after about 1 minute of non-operation. To turn on the camera again, just press the shutter button halfway (p.35).
- You can change the auto power-off time with the menu's [**Auto power off**] setting (p.44).







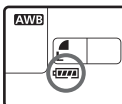

If you set the power switch to <OFF> while an image is being recorded to the card, [**Recording ...**] will be displayed and the power will turn off after the card finishes recording the image.

Checking the Battery Level

When the power switch is set to <ON>, the battery level will be indicated in one of six levels: A blinking battery icon () indicates that the battery will be exhausted soon.





Icon						
Level (%)	100 - 70	69 - 50	49 - 20	19 - 10	9 - 1	0

Battery Life

Temperature	At 23°C / 73°F	At 0°C / 32°F
No Flash	Approx. 1000	Approx. 900
50% Flash Use	Approx. 800	Approx. 750

- The figures above are based on a fully-charged Battery Pack LP-E6, no Live View shooting, and CIPA (Camera & Imaging Products Association) testing standards.
- Battery Grip BG-E7 approximately doubles the number of possible shots with two LP-E6 batteries installed. With size-AA/LR6 alkaline batteries, the number of possible shots at 23°C / 73°F is approx. 400 shots without flash use and approx. 300 shots with 50% flash use.



- The number of possible shots will decrease with any of the following operations:
 - Pressing the shutter button halfway for a prolonged period.
 - Often activating only the AF without taking a picture.
 - Using the LCD monitor often.
 - Using the lens Image Stabilizer.
- The lens operation is powered by the camera's battery. Depending on the lens used, the number of possible shots may be lower.
- For battery life with Live View shooting, see page 133.
- See the [**ⓘ**: **Battery info.**] menu to further check the battery's condition (p.230).
- If size-AA/LR6 batteries are used in Battery Grip BG-E7, a four-level indicator will be displayed. ([ / ]) will not be displayed.)

Installing and Removing the CF Card

Although the thickness is different between the two types of CF (CompactFlash) cards, the camera is compatible with both types. It is also compatible with Ultra DMA (UDMA) cards and hard disk-type cards.

Installing the Card

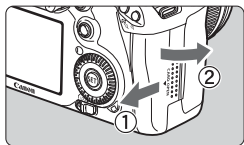

1 Open the cover.

- Slide the cover as shown by the arrow to open it.

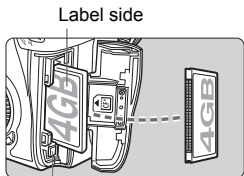

Label side

2 Insert the card.

- As shown in the illustration, face the label side toward you and insert the end with the small holes into the camera.

If the card is inserted in the wrong way, it may damage the camera.

- ▶ The card ejection button will stick out.

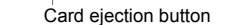

Card ejection button

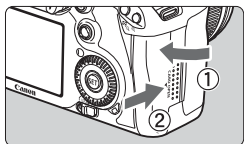

3 Close the cover.

- Close the cover and slide it in the direction shown by the arrow until it snaps shut.
- ▶ When you set the power switch to <ON>, the number of remaining shots will be displayed on the LCD panel.

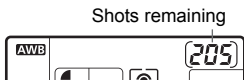

Shots remaining



- The number of shots remaining depends on the remaining capacity of the card, image-recording quality, ISO speed, etc.
- Setting the [Release shutter without card] menu option to [Disable] will prevent you from forgetting to install a card (p.238).

Removing the Card

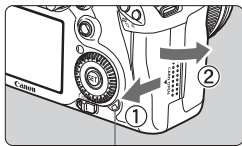

Access lamp

1 Open the cover.

- Set the power switch to <OFF>.
- **Make sure the access lamp is off, then open the cover.**

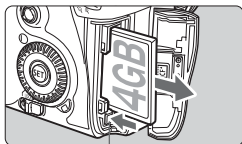

Card ejection button

2 Remove the card.

- Press the card ejection button.
- ▶ The card will come out.
- Close the cover.

- ⚠ ● **The access lamp lights or blinks while the picture is taken, when data is being transferred to the card and when data is being recorded, read, or erased on the card. While the access lamp is lit or blinking, never do any of the following. Doing so may damage the image data. It may also damage the card or camera.**
 - **Opening the card slot cover.**
 - **Removing the battery.**
 - **Shaking or banging the camera around.**
- If the card already contains recorded images, the image number might not start from 0001 (p.80).
- If a card-related error message is displayed on the LCD monitor, remove and reinstall the card. If the error persists, use a different card. If you can transfer all the images in the card to a computer, transfer all the images and then format the card (p.43). The card may then return to normal.
- When holding a hard disk-type card, always hold its sides. You may damage the card by holding its flat surfaces. Compared to CF cards, hard disk-type cards are more vulnerable to vibration and physical shock. If you use such a card, be careful not to subject the camera to vibration or physical shock especially while recording or displaying images.

Attaching and Detaching a Lens

Attaching a Lens

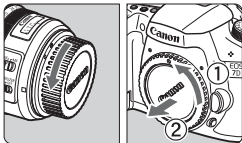

1 Remove the caps.

- Remove the rear lens cap and the body cap by turning them as shown by the arrow.

EF-S lens mount index

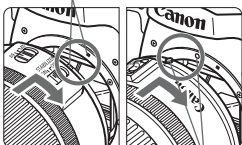

EF lens mount index

2 Attach the lens.

- Align the EF-S lens with the camera's white EF-S lens mount index and turn the lens as shown by the arrow until it clicks in place.
- When attaching a lens other than an EF-S lens, align the lens with the red EF lens mount index.

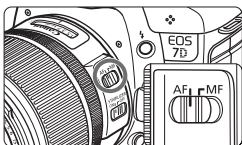

3 On the lens, set the focus mode switch to <AF> (autofocus).

- If it is set to <MF> (manual focus), autofocus will not operate.

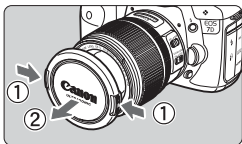

4 Remove the front lens cap.

Minimizing Dust

- When changing lenses, do it in a place with minimal dust.
- When storing the camera without a lens attached, be sure to attach the body cap to the camera.
- Remove dust on the body cap before attaching it.

About Zooming

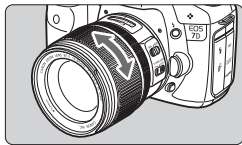

To zoom, turn the zoom ring on the lens with your fingers.

If you want to zoom, do it before focusing. Turning the zoom ring after achieving focus may throw off the focus slightly.

Detaching the Lens

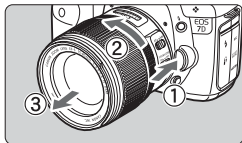

While pressing the lens release button, turn the lens as shown by the arrow.

- Turn the lens until it stops, then detach it.
- Attach the rear lens cap to the detached lens.

To owners of the EF-S18-200mm f/3.5-5.6 IS lens:

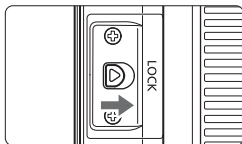

You can prevent the lens from extending out while you are carrying it around. Set the zoom ring to the 18mm wide-angle end, then slide the zoom ring lock lever to **<LOCK>**. The zoom ring can be locked only at the wide-angle end.

- Do not look at the sun directly through any lens. Doing so may cause loss of vision.
- If the front part (focusing ring) of the lens rotates during autofocus, do not touch the rotating part.

Image Conversion Factor

Since the image sensor size is smaller than the 35mm film format, it will look like the lens focal length is increased by 1.6x.



Image sensor size
(22.3 x 14.9 mm / 0.88 x 0.59 in.)

35mm image size
(36 x 24 mm / 1.42 x 0.94 in.)

About the Lens Image Stabilizer

When you use the IS lens' built-in Image Stabilizer, camera shake is corrected to obtain a less blurred shot. The procedure explained here is based on the EF-S15-85mm f/3.5-5.6 IS USM lens as an example.

* IS stands for Image Stabilizer.

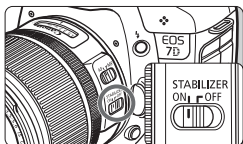

- 1 Set the IS switch to <ON>.**
 - Set the camera's power switch to <ON>.
- 2 Press the shutter button halfway.**
 - ▶ The Image Stabilizer will operate.
- 3 Take the picture.**
 - When the picture looks steady in the viewfinder, press the shutter button completely to take the picture.



- The Image Stabilizer is not effective for moving subjects.
- The Image Stabilizer may not be effective for excessive shaking such as on a rocking boat.
- With the EF28-135mm f/3.5-5.6 IS USM lens, the Image Stabilizer will not be very effective while you move the camera to take panned shots.



- The Image Stabilizer can operate with the lens focus mode switch set to either <AF> or <MF>.
- If the camera is mounted on a tripod, you can save battery power by switching the IS switch to <OFF>.
- The Image Stabilizer can operate even when the camera is mounted on a monopod.
- Some IS lenses enable you to switch the IS mode manually to suit the shooting conditions. However, the EF-S15-85mm f/3.5-5.6 IS USM, EF-S18-135mm f/3.5-5.6 IS, and EF-S18-200mm f/3.5-5.6 IS lenses switch the IS mode automatically.

Basic Operation

Adjusting the Viewfinder Clarity

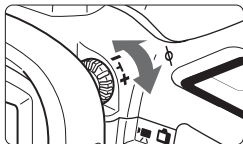

Turn the dioptic adjustment knob.

- Turn the knob left or right so that the AF points in the viewfinder look sharp.
- If the knob is difficult to turn, remove the eyecup (p.108).

If the camera's dioptic adjustment still cannot provide a sharp viewfinder image, using Dioptic Adjustment Lens Eg (sold separately) is recommended.

Holding the Camera

To obtain sharp images, hold the camera still to minimize camera shake.

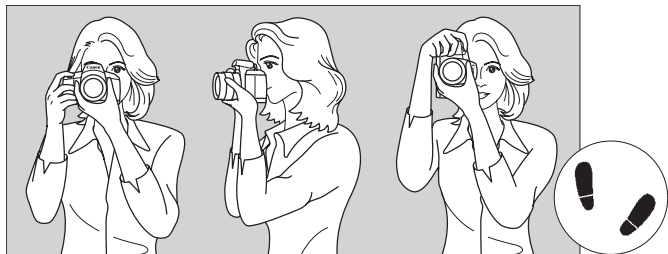

Horizontal shooting

Vertical shooting

1. Wrap your right hand around the camera grip firmly.
2. Hold the lens bottom with your left hand.
3. Press the shutter button lightly with your right hand's index finger.
4. Press your arms and elbows lightly against the front of your body.
5. Press the camera against your face and look through the viewfinder.
6. To maintain a stable stance, place one foot in front of the other.

For shooting while looking at the LCD monitor, see page 131.

Shutter Button

The shutter button has two steps. You can press the shutter button halfway. Then you can further press the shutter button completely.

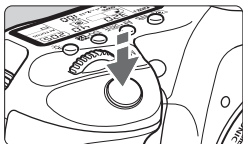

Pressing halfway

This activates autofocus and automatic exposure metering that sets the shutter speed and aperture.

The exposure setting (shutter speed and aperture) is displayed on the LCD panel and in the viewfinder (ⓘ4).

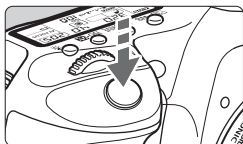

Pressing completely

This releases the shutter and takes the picture.

Preventing Camera Shake

Camera movement during the moment of exposure is called camera shake. Camera shake can cause blurred pictures. To prevent camera shake, note the following:

- Hold and steady the camera as shown on the previous page.
- Press the shutter button halfway to autofocus, then press the shutter button completely.





- In the **P/Tv/Av/M/B** modes, pressing the <AF-ON> button will execute the same operation as pressing the shutter button halfway.
- If you press the shutter button completely without pressing it halfway first or if you press the shutter button halfway and then press it completely immediately, the camera will take a moment before it takes the picture.
- Even during the menu display, image playback, and image recording, you can instantly go back to shooting-ready by pressing the shutter button halfway.

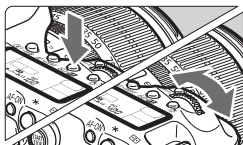

Making Selections with the Main Dial



(1) After pressing a button, turn the < > dial.

When you press a button, its function remains selected for 6 seconds () . During this time, you can turn the <  > dial to set the desired setting. When the function turns off or if you press the shutter button halfway, the camera will be ready to shoot.

- Use this dial to select or set the metering mode, AF mode, ISO speed, AF point, etc.

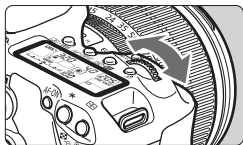

(2) Turn the < > dial only.

While looking at the viewfinder or LCD panel, turn the <  > dial to set the desired setting.



- Use this dial to set the shutter speed, aperture, etc.



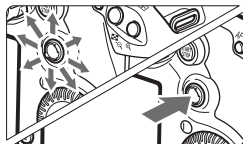

Operating the Multi-controller



The <  > consists of eight direction keys and a button at the center.



- Use it to select the AF point, correct the white balance, move the AF point or magnifying frame during Live View shooting, scroll the playback image during magnified view, operate the Quick Control screen, etc. You can also use it to select or set menu options (except [] **Erase images**] and [] **Format**]).

Making Selections with the Quick Control Dial

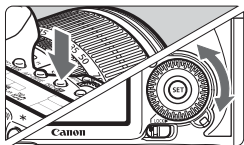
Before using the , set the Quick Control Dial switch to .



(1) After pressing a button, turn the dial.

When you press a button, its function remains selected for 6 seconds (). During this time, you can turn the  dial to set the desired setting.

When the function turns off or if you press the shutter button halfway, the camera will be ready to shoot.

- Use this dial to select or set the white balance, drive mode, flash exposure compensation, AF point, etc.

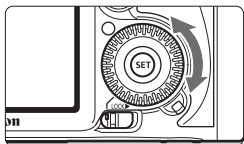

(2) Turn the dial only.

While looking at the viewfinder or LCD panel, turn the  dial to set the desired setting.



- Use this dial to set the exposure compensation amount, the aperture setting for manual exposures, etc.

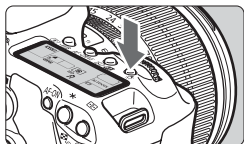

You can do step (1) even when the Quick Control Dial switch is set to .

LCD Panel Illumination



Turn on ()/off the LCD panel illumination by pressing the  button. During a bulb exposure, pressing the shutter button completely will turn off the LCD panel illumination.

Using the Quick Control Screen

The shooting settings are displayed on the LCD monitor where you can directly select and set the functions. This is called the Quick Control screen.

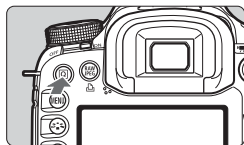

1 Display the Quick Control screen.

- Press the **<Q>** button.
- ▶ The Quick Control screen will appear ()



 (Full Auto)

2 Set the desired setting.

- Use **<Q>** to select a function.
- In the **<Q>** (Full Auto) mode, the image-recording quality (p.58) and the drive mode for single shooting or 10-sec. self-timer/remote control (p.93, 110) can be selected.
- ▶ The selected function is displayed on the screen's bottom.
- Turn the **<Q>** or **<Q>** dial to change the setting.



P/Tv/Av/M/B

3 Take the picture.

- Press the shutter button completely to take the picture.
- ▶ The LCD monitor turns off and the captured image is displayed.

 Regarding the **<CA>** (Creative Auto) mode, see page 53.

Quick Control Screen Nomenclature

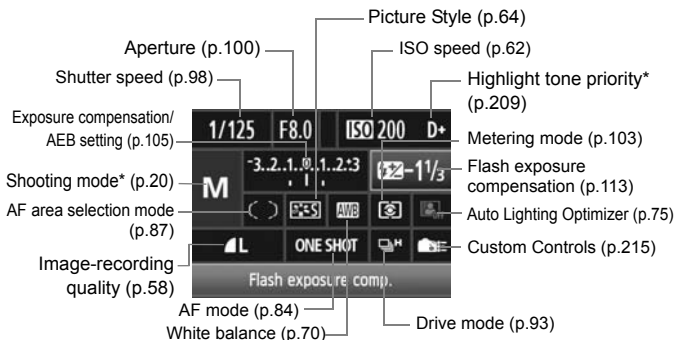

 Asterisked functions cannot be set with the Quick Control screen.

Function Setting Display



- On the Quick Control screen, select the function and press $\langle \text{SET} \rangle$. The respective setting screen will then appear (except for the shutter speed and aperture).
- Turn the $\langle \text{DISP} \rangle$ or $\langle \text{WB} \rangle$ dial to change the setting.
- Press $\langle \text{SET} \rangle$ to finalize the setting and return to the Quick Control screen.

MENU Menu Operations

You can set various functions with the menus such as the image-recording quality, date/time, etc. While looking at the LCD monitor, use the <MENU> button on the camera back and the <Main Dial> <Quick Control Dial> dials.

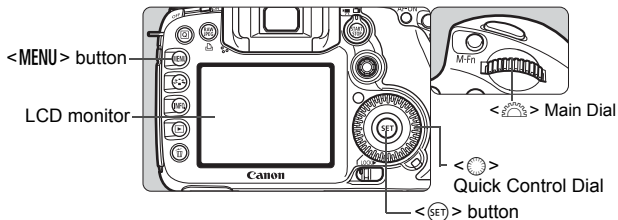

Fully-Automatic Modes (□/CA) Menu Screen



Quality	HL
Red-eye On/Off	Off
Beep	On
Release shutter without card	
Review time	2 sec.

* Some menu tabs and menu items are not displayed in the fully-automatic modes.

P/Tv/Av/M/B Menu Screen

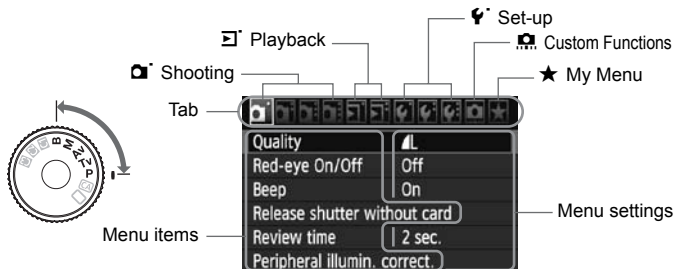

Menu Setting Procedure

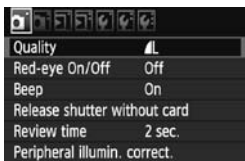

1 Display the menu.

- Press the <MENU> button to display the menu.

2 Select a tab.

- Turn the <◀☀▶> dial to select a tab.

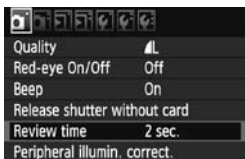

3 Select the desired item.

- Turn the <☀> dial to select the item, then press <⊙SET>.

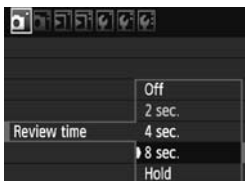

4 Select the setting.

- Turn the <☀> dial to select the desired setting.
- The current setting is indicated in blue.

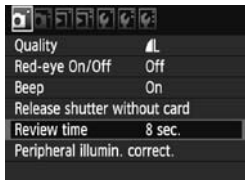

5 Set the desired setting.

- Press <⊙SET> to set it.

6 Exit the menu.

- Press the <MENU> button to exit the menu and return to camera shooting.



- The explanation of menu functions hereinafter assumes that you have pressed the <MENU> button to display the menu screen.
- You can also use <☀> to set menu settings. (Except for [E] Erase images] and [F] Format].)
- A list of menu functions is on page 238.

Before You Start

MENU Setting the Interface Language



1 Select [Language].

- Under the [☺] tab, select [Language] (the third item from the top), then press <SET>.



2 Set the desired language.

- Turn the <☉> or <☀> dial to select the language, then press <SET>.
- ▶ The interface language will change.

MENU Setting the Date and Time

Check if the camera's date and time are set correctly. If necessary, set the correct date and time.



1 Select [Date/Time].

- Under the [☺] tab, select [Date/Time], then press <SET>.



2 Set the date, time and date display format.

- Turn the <☉> dial to select the number.
- Press <SET> so ☺ is displayed.
- Turn the <☉> dial to select the desired setting, then press <SET> (Returns to ☐).

3 Exit the setting.

- Turn the <☉> dial to select [OK], then press <SET>.
- ▶ The date/time will be set and the menu will reappear.

It is important to set the correct date/time because it will be recorded together with each captured image.

MENU Formatting the Card

If the card is new or was previously formatted by another camera or personal computer, formatting the card with the camera is recommended.

- !** When the card is formatted, all images and data in the card will be erased. Even protected images will be erased, so make sure there is nothing you need to keep. If necessary, transfer the images to a personal computer, etc., before formatting the card.

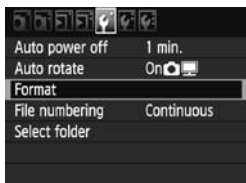

1 Select [Format].

- Under the [] tab, select [Format], then press <SET>.



2 Select [OK].

- Turn the <DIAL> dial to select [OK], then press <SET>.
- ▶ The card will be formatted.
- ▶ When the formatting is completed, the menu will reappear.



- !** When the card is formatted or data is erased, only the file management information is changed. The actual data is not completely erased. Be aware of this when selling or discarding the card. When discarding the card, destroy the card physically to prevent personal data from being leaked.

- The card capacity displayed on the card format screen might be smaller than the capacity indicated on the card.

MENU Set the Power-off Time/Auto Power Off

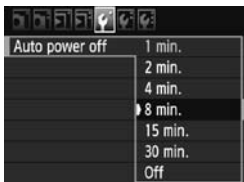
You can change the auto power-off time for the camera to turn off automatically after a certain period of non-operation. If you do not want the camera to turn off automatically, set this to **[Off]**. After the power turns off, you can turn on the camera again by pressing the shutter button or other button.



- 1 Select [Auto power off].**
 - Under the [] tab, select **[Auto power off]**, then press <SET>.
- 2 Set the desired time.**
 - Turn the <> dial to select the setting, then press <SET>.

 Even if **[Off]** has been set, the LCD monitor will turn off automatically after 30 min. to save power. (The camera's power does not turn off.)

MENU Reverting the Camera to the Default Settings ☆

The camera's shooting settings and menu settings can be reverted to the default.



1 Select [Clear all camera settings].

- Under the [] tab, select [**Clear all camera settings**], then press <SET>.



2 Select [OK].

- Turn the < > dial to select [OK], then press <SET>.
- ▶ Setting [**Clear all camera settings**] will reset the camera to the following default settings:



Shooting Settings

AF mode	One-Shot AF
AF area selection mode	Auto selection 19-point AF
Metering mode	(Evaluative metering)
ISO speed	A (Auto)
Drive mode	(Single shooting)
Exposure compensation/AEB	Canceled
Flash exposure compensation	0 (Zero)
Custom Functions	Unchanged

Image-recording Settings

Quality	L
One-touch RAW+JPEG	RAW L
Picture Style	Standard
Auto Lighting Optimizer	Standard
Peripheral illumination correction	Enable/ Correction data retained
Color space	sRGB
White balance	AWB (Auto)
WB correction	Canceled
WB-BKT	Canceled
File numbering	Continuous
Auto cleaning	Enable
Dust Delete Data	Erased

Camera Settings

VF grid display	Disable
Auto power off	1 min.
Beep	On
Release shutter without card	Enable
Review time	2 sec.
Highlight alert	Disable
AF point display	Disable
Histogram	Brightness
Image jump w/ 	10 images
Auto rotate	On  
LCD brightness	Auto: Standard
Date/Time	Unchanged
Language	Unchanged
Video system	Unchanged
INFO. button display options	All items selected
Camera user setting	Unchanged
Copyright information	Unchanged
My Menu settings	Unchanged

Live View Shooting Settings

Live View shooting	Enable
AF mode	Live mode
Grid display	Off
Exposure simulation	Enable
Silent shooting	Mode 1
Metering timer	16 sec.

Movie Shooting Settings

AF mode	Live mode
Grid display	Off
Movie-recording size	1920x1080 
Sound recording	On
Silent shooting	Mode 1
Metering timer	16 sec.

Displaying the Grid and Electronic Level

The grid and electronic level can be displayed to help keep the camera aimed straight. The grid is displayed in the viewfinder, and the electronic level is displayed on the LCD monitor.

Displaying the Grid

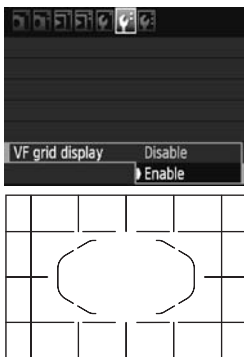

- 1 Select [VF grid display].**
 - Under the [] tab, select [**VF grid display**], then press <SET>.
- 2 Select [Enable].**
 - Turn the < > dial to select [**Enable**], then press <SET>.
 - The grid will be displayed in the viewfinder.

The grid can also be displayed during Live View shooting and movie shooting (p.136, 156).

Displaying the Electronic Level on the LCD Monitor

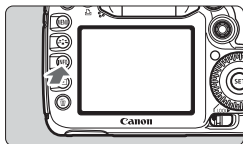

1 Press the <INFO.> button.

- Each time you press the <INFO.> button, the screen display will change.
- Display the electronic level.
- If the electronic level does not appear, set the menu's [INFO. button display options] option to display the electronic level (p.228).

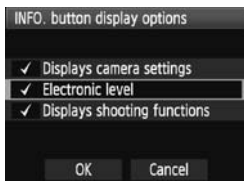

2 Check the camera's roll and pitch.

- The horizontal and vertical tilt are displayed in 1° increments.
- The red line turning green indicates that the tilt is corrected.



Vertical level

Horizontal level



- Even when the tilt is corrected, there is a margin of error of $\pm 1^\circ$.
- If the camera is significantly tilted, the electronic level's margin of error will be greater.

- The electronic level can also be displayed during Live View shooting and movie shooting (p.134, 152).
- The electronic level can also be displayed in the viewfinder using the AF point display (p.221).

☐ Fully Automatic Shooting



Area AF frame

1 Set the Mode Dial to <☐>.



2 Aim the Area AF frame over the target subject.

- All the AF points will be used to focus, and generally the closest object will be focused.
- Aiming the center of the Area AF frame over the subject will make focusing easier.

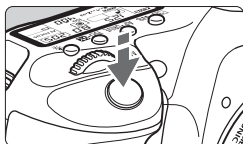

3 Focus the subject.

- Press the shutter button halfway, and the lens focusing ring will rotate to focus.
- ▶ The AF point(s) which achieve(s) focus will be displayed. At the same time, the beeper will sound and the focus confirmation light <●> in the viewfinder will light.
- ▶ Under low-light conditions, the viewfinder will flash in red to illuminate the AF point.
- ▶ If necessary, the built-in flash will pop-up automatically.



Focus confirmation light

4 Take the picture.

- Press the shutter button completely to take the picture.
- ▶ The captured image will be displayed for about 2 sec. on the LCD monitor.
- If the built-in flash has popped up, you can push it back down with your fingers.

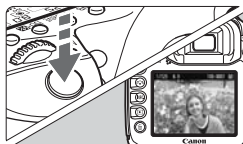

? FAQ

- **The focus confirmation light <●> blinks and focus is not achieved.**
Aim the center of the Area AF frame over an area having good contrast, then press the shutter button halfway (p.92). If you are too close to the subject, move away and try again.
- **Sometimes multiple AF points light up simultaneously.**
All those AF points have achieved focus. As long as the AF point covering the desired subject lights up, you can take the picture.
- **The beeper continues to beep softly. (The focus confirmation light <●> does not light.)**
It indicates that the camera is focusing continuously on a moving subject. (The focus confirmation light <●> does not light.) You can shoot a moving subject in focus.
- **Pressing the shutter button halfway does not focus the subject.**
If the focus mode switch on the lens is set to <MF> (Manual Focus), set it to <AF> (Auto Focus).
- **Although it is daylight, the flash popped up.**
For a backlit subject, the flash may pop up to help reduce the subject's dark shadow.
- **In low light, the built-in flash fired a series of flashes.**
Pressing the shutter button halfway may trigger the built-in flash to fire a series of flashes to assist autofocusing. This is called the AF-assist beam. It is effective up to approx. 4 meters/13.1 feet away.
- **Although flash was used, the picture came out dark.**
The subject was too far away. The subject should be within 5 meters/16.4 feet from the camera.
- **When flash was used, the bottom part of the picture came out unnaturally dark.**
The subject was too close to the camera, and a shadow was created by the lens barrel. The subject should be at least 1 meter/3.3 feet away from the camera. If a hood has been attached to the lens, remove it before taking the flash picture.

Full Auto Techniques

Recomposing the Shot



Depending on the scene, position the subject toward the left or right to create a balanced background and good perspective.

In the (Full Auto) mode, while you press the shutter button halfway to focus a still subject, the focus will be locked. You can then recompose the shot and press the shutter button completely to take the picture. This is called “focus lock”.

Shooting a Moving Subject



In the (Full Auto) mode, if the subject moves (distance to camera changes) during or after you focus, AI Servo AF will take effect to focus the subject continuously. As long as you keep aiming the AF point on the subject while pressing the shutter button halfway, the focusing will be continuous. When you want to take the picture, press the shutter button completely.

CA Creative Auto Shooting

The <□> Full Auto mode takes care of everything, whereas the <CA> Creative Auto mode enables you to easily change the picture's brightness, depth of field, color tone (Picture Style), etc. The default settings are the same as the <□> (Full Auto) mode.

* CA stands for Creative Auto.



1 Set the Mode Dial to <CA>.

- ▶ The Creative Auto screen appears on the LCD monitor.



2 Press the <Q> button.

- You can use <⊗> to select a function. (⊗10)
- For details about each function, see page 54-55.



3 Set the desired setting.

- Use <⊗> to select a function.
- ▶ A brief description of the selected function is displayed on the screen's bottom.
- Turn the <⊙> or <☀> dial to change the setting.

4 Take the picture.

- Press the shutter button completely to take the picture.



If you change the shooting mode or if the power turns off via auto power off (p.44) or by the power switch being set to <OFF>, the Creative Auto settings will revert to the default. However, the image-recording quality, self-timer and remote control settings will be retained.

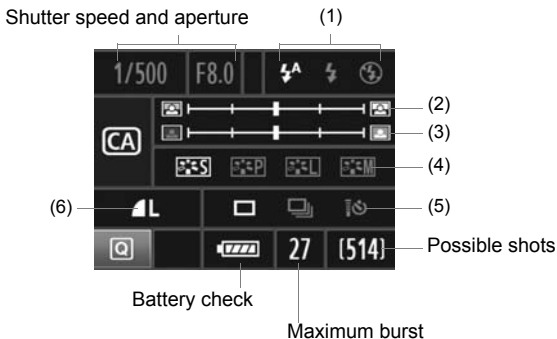

(1) Flash firing



<⚡A> (Auto firing), <⚡> (Flash on), or <⚡/> (Flash off) can be selected.

(2) Blurring/sharpening the background



If you move the index mark toward the left, the background will look more blurred. If you move it toward the right, the background will look more in focus.

Depending on the lens and shooting conditions, the background might not look so blurred. This setting cannot be set (grayed out) while the built-in flash is popped up. When flash is used, it will not be applied.

(3) Adjusting the picture brightness



If you move the index mark toward the left, the picture will look darker. If you move it toward the right, the picture will look brighter.

(4) Image effects



Besides the standard image effect, you can set it for portraits, landscapes, or black-and-white photos. (p.64: Picture Style)

< > (Standard): Standard image effect applicable to most scenes.

< > (Smooth skin tones): Effective for close-ups of women or children.

< > (Vivid blues and greens): For impressive landscapes.

< > (Monochrome image): Creates black-and-white photos.

(5) Single, continuous, and self-timer shooting



< > (Low-speed continuous shooting): Shoot continuously at a maximum of about 3 frames per second (fps).

< > (10-sec. self-timer/Remote control): See the “Using the Self-timer” note () on p.94. Remote control shooting is also possible. (p.110)

* By pressing the < AF•DRIVE > button, you can display the [Drive mode] selection screen and set the same settings.

(6) Image-recording quality



To set the image-recording quality, see “Setting the Image-recording Quality” on page 58-60. By pressing < >, you can display the [Quality] selection screen and set the same settings.

MENU Setting the Image Review Time

You can set how long the image is displayed on the LCD monitor immediately after capture. To keep the image displayed, set **[Hold]**. To not have the image displayed, set **[Off]**.

1 Select **[Review time]**.

- Under the **[** tab, select **[Review time]**, then press **<SET>**.

2 Set the desired time.

- Turn the **< >** dial to select the setting, then press **<SET>**.

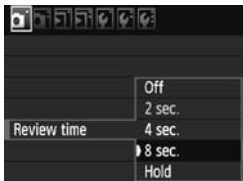

 If **[Hold]** is set, the image will be displayed until the auto power off time elapses.

3

Image Settings

This chapter explains image-related function settings: Image-recording quality, ISO speed, Picture Style, white balance, Auto Lighting Optimizer, lens peripheral illumination correction, etc.

- In fully-automatic modes (/CA), only the image-recording quality, lens peripheral illumination correction, and file numbering method can be set as explained in this chapter. Folders can also be created and selected.
- The ☆ icon on the upper right of the page title indicates that the function can be used when the Mode Dial is set to <P/Tv/Av/M/B>.

MENU Setting the Image-recording Quality

You can select the pixel count and the image quality. Six JPEG recording quality settings are provided: **L**/**L**/**M**/**M**/**S**/**S**. Three RAW recording quality settings are provided: **RAW**, **M RAW**, and **S RAW**. RAW images must be processed with the provided software (p.60).



1 Select [Quality].

- Under the [☑] tab, select [Quality], then press <SET>.

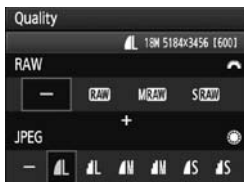

2 Select the image-recording quality.

- To select a RAW setting, turn the <☰> dial. To select a JPEG setting, turn the <☉> dial.
- On the upper right, the "****M (megapixels) **** x ****" number indicates the recorded pixel count, and [***] is the number of possible shots (displayed up to 999).
- Press <SET> to set it.

Image-recording Quality Setting Examples

L only

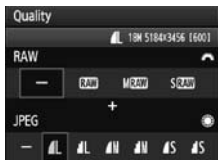

RAW only

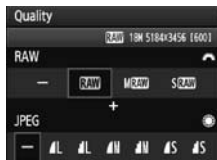

RAW + L

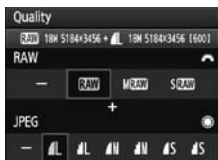



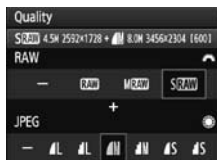











S RAW + M











* If [-] is set for both RAW and JPEG, **L** will be set.

Guide to Image-recording Quality Settings (Approx.)

Quality		Pixels (megapixels)	Printing Size	File Size (MB)	Possible Shots	Maximum Burst
JPEG	 L	Approx. 17.9 (17.9M)	A2 or larger	6.6	593	94 (126)
	 L			3.3	1169	469 (1169)
	 M	Approx. 8.0 (8M)	Around A3	3.5	1122	454 (1122)
	 M			1.8	2178	2178 (2178)
	 S	Approx. 4.5 (4.5M)	Around A4	2.2	1739	1739 (1739)
	 S			1.1	3297	3297 (3297)
RAW	 RAW	Approx. 17.9 (17.9M)	A2 or larger	25.1	155	15 (15)
	 M RAW	Approx. 10.1 (10M)	Around A3	17.1	229	24 (24)
	 S RAW	Approx. 4.5 (4.5M)	Around A4	11.4	345	38 (38)
RAW + JPEG	 RAW	Approx. 17.9 Approx. 17.9	A2 or larger	25.1+6.6	122	6 (6)
	 L		A2 or larger			
	 M RAW	Approx. 10.1 Approx. 17.9	Around A3	17.1+6.6	164	6 (6)
	 L		A2 or larger			
 S RAW	Approx. 4.5 Approx. 17.9	Around A4	11.4+6.6	217	6 (6)	
 L		A2 or larger				

- Figures for the file size, possible shots, and maximum burst during continuous shooting are based on Canon's testing standards (ISO 100 and Standard Picture Style) using a 4GB card. **These figures will vary depending on the subject, card brand, ISO speed, Picture Style, Custom Functions, etc.**
- The maximum burst applies to high-speed continuous shooting. Figures in parentheses apply to an Ultra DMA (UDMA) 4GB card based on Canon's testing standards.



- If you select both RAW and JPEG, the same image will be recorded simultaneously to the card in both types at the selected image-recording quality. The two images will be saved in the same folder with the same file numbers (file extension .JPG for JPEG and .CR2 for RAW).
- The icons are read as follows:  (RAW),  (Medium RAW),  (Small RAW), JPEG,  (Fine),  (Normal),  (Large),  (Medium), and  (Small).

About RAW

A RAW image is the data output by the image sensor, converted to digital data and recorded on the card as is. You can select from **RAW**, **M RAW**, or **S RAW** (Commonly referred as RAW in this manual). With RAW images, you can use the provided software to make various adjustments as desired and then generate a JPEG, TIFF, etc., image.



 Commercially-available software might not be able to display RAW images. Using the provided software is recommended.

Maximum Burst During Continuous Shooting

The maximum burst during continuous shooting indicated on the preceding page is the number of continuous shots that can be taken without stopping, based on a formatted 4GB card.



The number is displayed on the bottom right in the viewfinder. If the maximum burst is 99 or higher, “99” will be displayed.

-  ● The maximum burst is displayed even when a card is not inserted in the camera. Make sure that a card is loaded before taking a picture.
- If [ **C.Fn II -2: High ISO speed noise reduction**] is set to [**2: Strong**], the maximum burst will be greatly reduced (p.208).

 If the viewfinder displays “99” for the maximum burst, it means the maximum burst is 99 or higher. If the maximum burst decreases to 98 or lower and the internal buffer memory becomes full, “buSY” will be displayed in the viewfinder and on the LCD panel and shooting will be disabled temporarily. If you stop the continuous shooting, the maximum burst will increase. After all the captured images are written to the card, the maximum burst will be as listed on page 59.

One-touch RAW+JPEG ☆

If the current recording quality is JPEG only, you can press the <RAW/JPEG> button to also capture a RAW image (RAW by default) at the same time. If the current recording quality is RAW only, press the button to also capture a JPEG image (L by default).

This button will not work if the camera is already set (p.58) to capture RAW and JPEG images at the same time.



1 Select [One-touch RAW+JPEG].

- Under the [Q] tab, select [One-touch RAW+JPEG], then press <SET>.



2 Select RAW or JPEG.

- Turn the <Q> dial and select RAW or JPEG, then press <SET>.

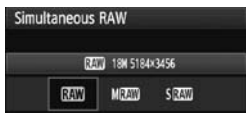

3 Select the image-recording quality.

- Turn the <Q> dial to select the image-recording quality, then press <SET>.

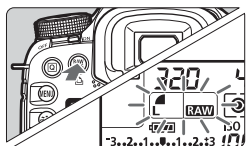

4 Take the picture.

- Press the <RAW/JPEG> button.
 - ▶ The image-recording quality will blink on the LCD panel. To cancel the setting, press the <RAW/JPEG> button again.
- Press the shutter button completely to take the picture.
 - ▶ After the picture is taken, the setting will be canceled.



- This setting can also be combined with white balance bracketing and AEB shooting.
- You can also cancel the setting by pressing the <Q>, <MENU>, <ZOOM>, or <PLAY> button or operating the Live View shooting/Movie shooting switch or power switch.

ISO: Setting the ISO Speed ☆

Set the ISO speed (image sensor's sensitivity to light) to suit the ambient light level. In the fully-automatic modes (□/CA), the ISO speed is set automatically (p.63).



1 Press the <ISO-> button. (⊙6)

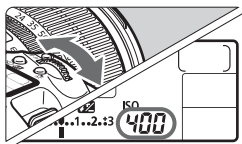

2 Set the ISO speed.

- While looking at the LCD panel or viewfinder, turn the < > dial.
- It can be set within ISO 100-6400 in 1/3-stop increments.
- With “A” selected, the ISO speed will be set automatically (p.63).

ISO Speed Guide

ISO Speed	Shooting Situation (No flash)	Flash Range
100 - 400	Sunny outdoors	The higher the ISO speed, the farther the flash range will be (p.112).
400 - 1600	Overcast skies or evening time	
1600 - 6400, H	Dark indoors or night	

- If [ C.Fn II -3: Highlight tone priority] is set to [1: Enable], the settable ISO speed range will be ISO 200 - 6400 (p.209).
- Using a high ISO speed or shooting in high-temperature conditions may result in more grainy images. Long exposures can also cause irregular colors in the image.
- When you shoot at high ISO speeds, noise (horizontal banding, dots of light, etc.) may appear.

With [ C.Fn I -3: ISO expansion] set to [1: On], “H” (equivalent to ISO 12800) can also be set (p.206).

About “A” (Auto) ISO Speed

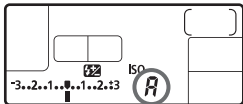

If the ISO speed is set to “A”, the actual ISO speed to be set will be displayed when you press the shutter button halfway. As indicated below, the ISO speed will be set automatically to suit the shooting mode.

Shooting Mode	ISO Speed Setting
/ / P / Tv / Av / M	ISO 100 - 3200
B	Fixed at ISO 400
With flash	Fixed at ISO 400*

* If fill flash results in overexposure, ISO 100 or a higher ISO will be set.

* If the shooting mode is <P> or fully-automatic (/) and bounce flash is used with an external Speedlite, the ISO speed will be set automatically within 400 - 1600.

Selecting a Picture Style ☆

By selecting a Picture Style, you can obtain image effects matching your photographic expression or the subject.

In the <□> (Full Auto) mode, you cannot select the Picture Style.

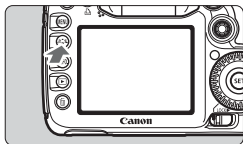



1 Press the < > button.

- When the camera is ready to shoot, press the <  > button.
- ▶ The Picture Style screen will appear.



2 Select a Picture Style.

- Turn the <  > or <  > dial to select a Picture Style, then press <  >.
- ▶ The Picture Style will take effect and the camera will be ready to shoot.

 You can also use the [ Picture Style] menu to select the Picture Style.

Picture Style Effects

Standard (CA): Standard)

The image looks vivid, sharp, and crisp. This is a general-purpose Picture Style suitable for most scenes. This is set automatically in the <□> (Full Auto) mode.

Portrait (CA): Smooth skin tones)

For nice skin tones. The image looks softer. Effective for close-ups of women or children.

By changing the [**Color tone**] (p.66), you can adjust the skin tone.

Landscape (CA): Vivid blues and greens)

For vivid blues and greens, and very sharp and crisp images. Effective for impressive landscapes.

Neutral

This Picture Style is for users who prefer to process images with their computer. For natural colors and subdued images.

Faithful

This Picture Style is for users who prefer to process images with their computer. When the subject is captured under a daylight color temperature of 5200K, the color is adjusted colorimetrically to match the subject's color. The image is dull and subdued.

Monochrome (CA: Monochrome image)

Creates black-and-white images.



Black-and-white images shot in JPEG cannot be reverted to color. If you want to later shoot pictures in color, make sure the **[Monochrome]** setting has been canceled. When **[Monochrome]** is selected, <B/W> will appear in the viewfinder and on the LCD panel.

User Def. 1-3







You can register a basic style such as **[Portrait]**, **[Landscape]**, a Picture Style file, etc., and adjust it as desired (p.68). Any User-Defined Picture Style which has not been set will have the same settings as the Standard Picture Style.

About the Symbols

The symbols on the top of the Picture Style selection screen refer to parameters such as **[Sharpness]** and **[Contrast]**. The numerals indicate the parameter settings, such as **[Sharpness]** and **[Contrast]**, for each Picture Style.



Symbols

	Sharpness
	Contrast
	Saturation
	Color tone
	Filter effect (Monochrome)
	Toning effect (Monochrome)

Customizing a Picture Style ☆

You can customize a Picture Style by adjusting individual parameters like [Sharpness] and [Contrast]. To see the resulting effects, take test shots. To customize [Monochrome], see the next page.



1 Press the <INFO> button.

2 Select a Picture Style.

- Turn the <G> or <C> dial to select a Picture Style, then press the <INFO> button.



3 Select a parameter.

- Turn the <C> dial to select the parameter, then press <SET>.



4 Set the parameter.

- Turn the <C> dial to set the parameter as desired, then press <SET>.
- Press the <MENU> button to save the adjusted parameter. The Picture Style selection screen will reappear.
- ▶ Any settings different from the default will be displayed in blue.



Parameter Settings and Effects

Sharpness	0: Less sharp outline	+7: Sharp outline
Contrast	-4: Low contrast	+4: High contrast
Saturation	-4: Low saturation	+4: High saturation
Color tone	-4: Reddish skin tone	+4: Yellowish skin tone



- By selecting [**Default set.**] in step 3, you can revert the respective Picture Style to its default parameter settings.
- To shoot with the Picture Style you modified, follow step 2 on the preceding page to select the modified Picture Style and then shoot.

Monochrome Adjustment

For Monochrome, you can also set [**Filter effect**] and [**Toning effect**] in addition to [**Sharpness**] and [**Contrast**] explained on the preceding page.

Filter Effect

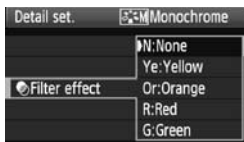

With a filter effect applied to a monochrome image, you can make white clouds or green trees stand out more.

Filter	Sample Effects
N: None	Normal black-and-white image with no filter effects.
Ye: Yellow	The blue sky will look more natural, and the white clouds will look crisper.
Or: Orange	The blue sky will look slightly darker. The sunset will look more brilliant.
R: Red	The blue sky will look quite dark. Fall leaves will look crisper and brighter.
G: Green	Skin tones and lips will look fine. Tree leaves will look crisper and brighter.



Increasing the [**Contrast**] will make the filter effect more pronounced.

Toning Effect

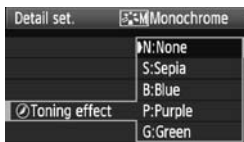

By applying a toning effect, you can create a monochrome image in that color. It can make the image look more impressive.

The following can be selected: [**N:None**] [**S:Sepia**] [**B:Blue**] [**P:Purple**] [**G:Green**].

Registering a Picture Style ☆



You can select a base Picture Style such as [Portrait] or [Landscape], adjust its parameters as desired and register it under [User Def. 1], [User Def. 2], or [User Def. 3].

You can create Picture Styles whose parameter settings such as for sharpness and contrast are different. You can also adjust the parameters of a Picture Style which has been registered to the camera with the provided software.

1 Press the button.



2 Select [User Def.].

- Turn the  or  dial to select [User Def. *], then press the <INFO.> button.

3 Press <SET>.

- With [Picture Style] selected, press <SET>.



4 Select the base Picture Style.

- Turn the  dial to select the base Picture Style, then press <SET>.
- To adjust the parameters of a Picture Style which has been registered to the camera with the provided software, select the Picture Style here.

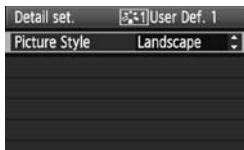



5 Select a parameter.

- Select a parameter such as [Sharpness], then press <SET>.







6 Set the parameter.

- Turn the <  > dial to set the parameter as desired, then press <  >.

For details, see “Customizing a Picture Style” on pages 66-67.

- Press the < **MENU** > button to register the new Picture Style. The Picture Style selection screen will then reappear.
- ▶ The base Picture Style will be indicated on the right of [**User Def. ***].

 If a Picture Style has already been registered under [**User Def. ***], changing the base Picture Style in step 4 will nullify the parameter settings of the registered Picture Style.

 To shoot with the registered Picture Style, follow step 2 on the preceding page to select [**User Def. ***] and then shoot.

WB: Setting the White Balance ☆

White balance (WB) is for making the white areas look white. Normally, the <AWB> (Auto) setting will obtain the correct white balance. If natural-looking colors cannot be obtained with <AWB>, you can select the white balance for each light source or set it manually by shooting a white object. In the fully-automatic modes (□/CA), <AWB> is set automatically.

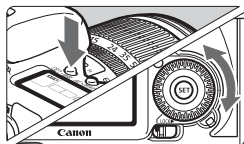

1 Press the <WB> button. (Ⓟ6)

2 Select the white balance.

- While looking at the LCD panel, turn the <mode> dial.



Display	Mode	Color Temperature (Approx. K: Kelvin)
AWB	Auto	3000 - 7000
☀	Daylight	5200
🏠	Shade	7000
☁	Cloudy, twilight, sunset	6000
☀	Tungsten light	3200
☀	White fluorescent light	4000
⚡	Flash use	6000
📷	Custom (p.71)	2000 - 10000
K	Color temperature (p.72)	2500 - 10000

About White Balance

To the human eye, a white object looks white regardless of the type of lighting. With a digital camera, the color temperature is adjusted with software to make the white areas look white. This adjustment serves as the basis for the color correction. The result is natural-looking colors in the pictures.

📷 You can also use the [White balance] menu to set the white balance.

Custom White Balance

Custom white balance enables you to manually set the white balance for a specific light source for better accuracy. Do this procedure under the actual light source to be used.



1 Photograph a white object.

- Look through the viewfinder and the area within the dotted line should cover a solid-white object.
- Focus manually and set the standard exposure for the white object.
- You can set any white balance.





2 Select [Custom WB].

- Under the [] tab, select [Custom WB], then press <SET>.
- ▶ The custom white balance selection screen will appear.



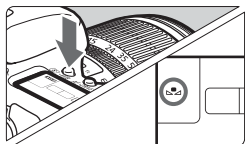

3 Import the white balance data.

- Turn the < > or < > dial to select the image captured in step 1, then press <SET>.
- ▶ On the dialog screen which appears, select [OK] and the data will be imported.
- When the menu reappears, press the <MENU> button to exit the menu.



4 Press the <·WB> button. (ⓘ6)

5 Select the custom white balance.

- Look at the LCD panel and turn the < > dial to select < >.

- If the exposure obtained in step 1 is way off, a correct white balance might not be obtained.
- If the image was captured while the Picture Style was set to **[Monochrome]** (p.65), it cannot be selected in step 3.

- Instead of a white object, an 18% gray card (commercially available) can produce a more accurate white balance.
- The personal white balance registered with the provided software will be registered under <☺>. If you do step 3, the data for the registered personal white balance will be erased.

Setting the Color Temperature

You can set the white balance's color temperature numerically in Kelvin. This is for advanced users.

1 Select **[White balance]**.

- Under the  tab, select **[White balance]**, then press <SET>.

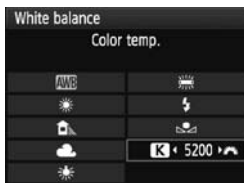

2 Set the color temperature.

- Turn the <☉> dial to select **[K]**.
- Turn the <☀> dial to set the color temperature, then press <SET>.
- The color temperature can be set from 2500K to 10000K in 100K increments.

- When setting the color temperature for an artificial light source, set white balance correction (magenta or green) as necessary.
- If you want to set <K> to the reading taken with a commercially-available color temperature meter, take test shots and adjust the setting to compensate for the difference between the color temperature meter's reading and the camera's color temperature reading.

WB White Balance Correction ☆

You can correct the white balance that has been set. This adjustment will have the same effect as using a commercially-available color temperature conversion filter or color compensating filter. Each color can be corrected to one of nine levels.

This is for advanced users who are familiar with using color temperature conversion or color compensating filters.

White Balance Correction

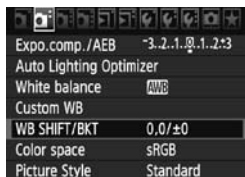

- 1 Select [WB SHIFT/BKT].
 - Under the [WB] tab, select [WB SHIFT/BKT], then press <SET>.

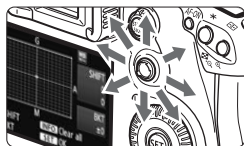

- 2 Set the white balance correction.
 - Use <WB> to move the "■" mark to the desired position.
 - B is for blue, A is amber, M is magenta, and G is green. The color in the respective direction will be corrected.

Sample setting: A2, G1

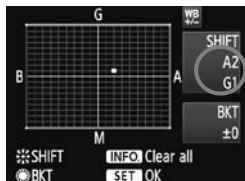

- On the upper right, "SHIFT" indicates the direction and correction amount.
- Pressing the <INFO.> button will cancel all the [WB SHIFT/BKT] settings.
- Press <SET> to exit the setting and return to the menu.



- During the white balance correction, <WB> will be displayed in the viewfinder and on the LCD panel.
- One level of the blue/amber correction is equivalent to 5 mireds of a color temperature conversion filter. (Mired: Measuring unit indicating the density of a color temperature conversion filter.)

White Balance Auto Bracketing

With just one shot, three images having a different color tone can be recorded simultaneously. Based on the color temperature of the current white balance setting, the image will be bracketed with a blue/amber bias or magenta/green bias. This is called white balance bracketing (WB-BKT). White balance bracketing is possible up to ± 3 levels in single-level increments.

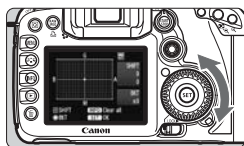

B/A bias ± 3 levels

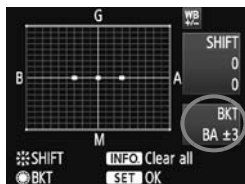

Set the white balance bracketing amount.

- In step 2 for white balance correction, when you turn the $\langle \odot \rangle$ dial, the “■” mark on the screen will change to “■■■” (3 points). Turning the dial to the right sets the B/A bracketing, and turning it to the left sets the M/G bracketing.
- ▶ On the right side of the screen, “BKT” indicates the bracketing direction and the bracketing amount.
- Pressing the $\langle \text{INFO} \rangle$ button will cancel all the [WB SHIFT/BKT] settings.
- Press $\langle \text{SET} \rangle$ to exit the setting and return to the menu.

Bracketing Sequence

The images will be bracketed in the following sequence: 1. Standard white balance, 2. Blue (B) bias, and 3. Amber (A) bias, or 1. Standard white balance, 2. Magenta (M) bias, 3. Green (G) bias.



- During WB bracketing, the maximum burst for continuous shooting will be lower and the number of possible shots will also decrease to one-third the normal number. Also, the white balance icon will blink on the LCD panel.
- You can also set white balance correction and AEB together with white balance bracketing. If you set AEB in combination with white balance bracketing, a total of nine images will be recorded for a single shot.
- Since three images are recorded for one shot, the card will take longer to record the shot.
- “BKT” stands for Bracketing.

MENU Auto Lighting Optimizer ☆

If the image comes out dark or the contrast is low, the brightness and contrast can be corrected automatically. With JPEG images, the correction is done when the image is captured. For RAW images, it can be corrected with Digital Photo Professional (provided software). The default setting is [Standard].

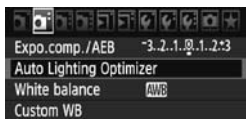

1 Select [Auto Lighting Optimizer].

- Under the [Auto] tab, select [Auto Lighting Optimizer], then press <SET>.



2 Set the correction setting.

- Turn the <DISP> dial to select the setting, then press <SET>.

3 Take the picture.

- The image will be recorded with the brightness and contrast corrected if necessary.



Sample of corrected brightness



- Depending on the shooting conditions, noise might increase.
- If a setting other than [Disable] is set and you use exposure compensation, flash exposure compensation, or manual exposure to darken the exposure, the image might still come out bright. If you want the darker exposure, set this to [Disable] first.



In fully-automatic modes (□/CA), [Standard] will be set automatically.

MENU Lens Peripheral Illumination Correction ■

Due to the lens characteristics, the four corners of the picture might look darker. This is called lens light fall-off or drop in peripheral illumination. With JPEG images, the correction is done when the image is captured. For RAW images, it can be corrected with Digital Photo Professional (provided software).

The default setting is **[Enable]**.

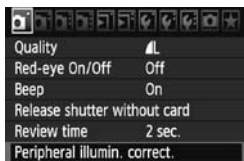

1 Select **[Peripheral illumin. correct.]**.

- Under the [] tab, select **[Peripheral illumin. correct.]**, then press < >.

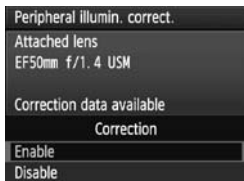

2 Set the correction setting.

- On the screen, check that the attached lens' **[Correction data available]** is displayed.
- If **[Correction data not available]** is displayed, see "About the Lens Correction Data" on the next page.
- Turn the < > dial to select **[Enable]**, then press < >.

3 Take the picture.

- The image will be recorded with the corrected peripheral illumination.



Correction enabled



Correction disabled

About the Lens Correction Data

The camera already contains lens peripheral illumination correction data for about 25 lenses. In step 2, if you select **[Enable]**, the peripheral light correction will be applied automatically for any lens whose correction data has been registered in the camera.

With the EOS Utility (provided software), you can check which lenses have their correction data registered in the camera. You can also register the correction data for unregistered lenses. For details, see the Software Instruction Manual (CD-ROM) for EOS Utility.



- For JPEG images already captured, lens peripheral illumination correction cannot be applied.
- Depending on shooting conditions, noise might appear on the image periphery.
- When using a third-party lens, setting the correction to **[Disable]** is recommended, even if **[Correction data available]** is displayed.



- Lens peripheral illumination correction is applied even when an Extender is attached.
- If the correction data for the attached lens has not been registered to the camera, the result will be the same as when the correction is set to **[Disable]**.
- The correction amount applied will be slightly lower than the maximum correction amount settable with Digital Photo Professional (provided software).
- If the lens does not have distance information, the correction amount will be lower.
- The higher the ISO speed, the lower the correction amount will be.

MENU Creating and Selecting a Folder

You can freely create and select the folder where the captured images are to be saved.

This is optional since a folder will be created automatically for saving captured images.

Create a Folder

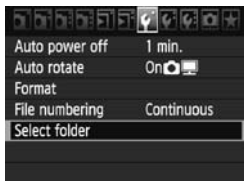

1 Select [Select folder].

- Under the [**F**] tab, select [**Select folder**], then press <SET>.

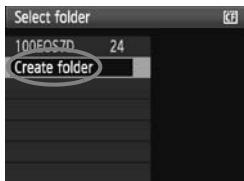

2 Select [Create folder].

- Turn the <DISP> dial to select [**Create folder**], then press <SET>.

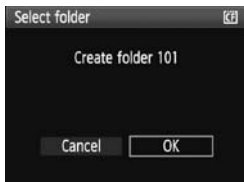

3 Create a new folder.

- Turn the <DISP> dial to select [**OK**], then press <SET>.
- ▶ A new folder with a higher one-up folder number is created.

Selecting a Folder

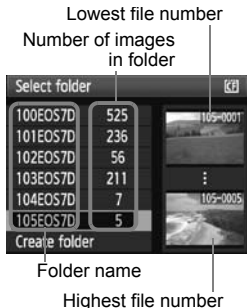

- With the Select folder screen displayed, turn the <◂> dial to select the desired folder, then press <SET> >.
- ▶ The folder where the captured images will be saved will be selected.
- Subsequent captured images will be recorded into the selected folder.

About Folders

As with “100EOS7D” for example, the folder name starts with three digits (folder number) followed by five alphanumeric characters. A folder can contain up to 9999 images (file No. 0001 - 9999). When a folder becomes full, a new folder with a higher one-up folder number is created automatically. Also, if manual reset (p.81) is executed, a new folder will be created automatically. Folders numbered from 100 to 999 can be created.

Creating Folders with a Personal Computer

With the card open on the screen, create a new folder named “DCIM”. Open the DCIM folder and create as many folders as necessary to save and organize your images. The folder name must follow the “100ABC_D” format where the first three digits is 100 - 999 followed by five alphanumeric characters. The five characters can be a combination of upper- or lower-case letters from A to Z, numerals, and an underscore “_”. There can be no space in the folder name. Also, folder names cannot have the same three-digit number such as “100ABC_D” and “100W_XYZ” even if the letters are different.

MENU File Numbering Methods

The file number is like the frame number on a roll of film. The captured images are assigned a sequential file number from 0001 to 9999 and saved in one folder. You can change how the file number is assigned. The file number will appear on a computer in this format:

IMG_0001.JPG.

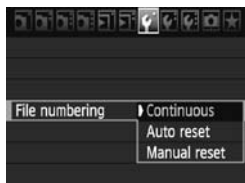

- 1 Select [File numbering].**
 - Under the [**F**] tab, select [**File numbering**], then press <SET>.
- 2 Select the file numbering method.**
 - Turn the <DIAL> dial to select the desired method, then press <SET>.

Continuous

Continues the file numbering sequence even after the card is replaced or a new folder is created.

Even after you replace the card or create a new folder, the file numbering continues in sequence up to 9999. This is convenient when you want to save the images numbered anywhere between 0001 to 9999 in multiple cards or folders into one folder in your personal computer.

If the replacement card or existing folder already contains images recorded previously, the file numbering of the new images might continue from the file numbering of the existing images in the card or folder. If you want to use continuous file numbering, you should use a newly-formatted card each time.

File numbering after replacing the card

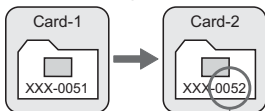

Next sequential file number

File numbering after creating a folder

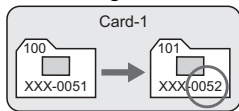

Auto Reset

Restarting the file numbering from 0001 each time the card is replaced or a new folder is created.

Whenever the card is replaced or a new folder created, the file numbering starts from 0001. This is convenient if you want to organize images according to cards or folders. If the replacement card or existing folder already contains images recorded previously, the file numbering of the new images might continue from the file numbering of the existing images in the card or folder. If you want to save images with the file numbering starting from 0001, use a newly formatted card each time.

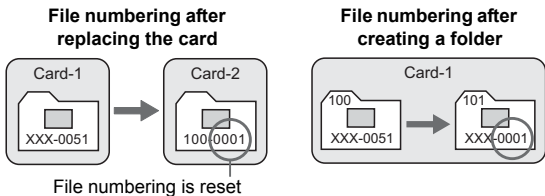

Manual Reset

To reset the file numbering to 0001 or to start from file number 0001 in a new folder.

When you reset the file numbering manually, a new folder is created automatically and the file numbering of images saved to that folder starts from 0001. This is convenient when you want to use different folders for the images taken yesterday and the ones taken today, for example. After the manual reset, the file numbering returns to continuous or auto reset.

! If the file number in folder No. 999 reaches 9999, shooting will not be possible even if the card still has storage capacity. The LCD monitor will display a message to replace the card. Replace with a new card.

📄 For both JPEG and RAW images, the file name will start with "IMG_". Movie file names will start with "MVI_". The extension will be ".JPG" for JPEG images, ".CR2" for RAW images, and ".MOV" for movies.

MENU Setting the Color Space ☆

The color space refers to the range of reproducible colors. With this camera, you can set the color space for captured images to sRGB or Adobe RGB. For normal shooting, sRGB is recommended.

In the fully-automatic modes (□/CA), sRGB is set automatically.

1 Select [Color space].

- Under the [M] tab, select [Color space], then press <SET>.

2 Set the desired color space.

- Select [sRGB] or [Adobe RGB], then press <SET>.



About Adobe RGB

This color space is mainly used for commercial printing and other industrial uses. This setting is not recommended if you do not know about image processing, Adobe RGB, and Design rule for Camera File System 2.0 (Exif 2.21). The image will look very subdued in the sRGB personal computer environment and with printers not compatible with Design rule for Camera File System 2.0 (Exif 2.21). Post-processing of the image with software will therefore be required.



- If the image is captured with the color space set to Adobe RGB, the file name will start with “_MG_” (first character is an underscore).
- The ICC profile is not appended. The ICC profile is explained in the Software Instruction Manual in the CD-ROM.

4

Setting the AF and Drive Modes



The 19 AF points in the viewfinder make AF shooting suitable for a wide variety of subjects and scenes.

You can also select the AF mode and drive mode best matching the shooting conditions and subject.

- The ☆ icon on the upper right of the page title indicates that the function can be used when the Mode Dial is set to **<P/Tv/Av/M/B>**.
- In fully-automatic modes (/CA), the AF mode, AF point selection, and drive mode are set automatically.



<AF> stands for auto focus. **<MF>** stands for manual focus.

AF: Selecting the AF Mode [☆]

Select the AF mode suiting the shooting conditions or subject. In fully-automatic modes (□/CA), “AI Focus AF” is set automatically.

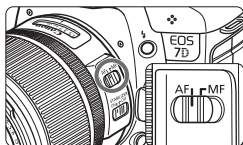

- 1 On the lens, set the focus mode switch to <AF>.

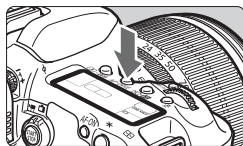

- 2 Press the <AF•DRIVE> button. (⊙6)

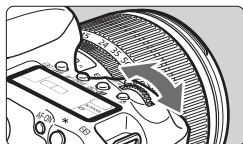

- 3 Select the AF mode.

- While looking at the LCD panel, turn the <⊙> dial.

ONE SHOT: One-Shot AF

AI FOCUS: AI Focus AF

AI SERVO: AI Servo AF

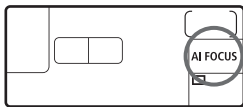

One-Shot AF for Still Subjects



AF point
Focus confirmation light

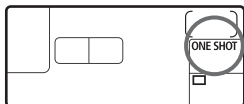

Suited for still subjects. When you press the shutter button halfway, the camera will focus only once.

- When focus is achieved, the AF point which achieved focus will be displayed, and the focus confirmation light <●> in the viewfinder will also light.
- With evaluative metering, the exposure setting will be set at the same time focus is achieved.
- While you hold down the shutter button halfway, the focus will be locked. You can then recompose the shot if desired.
- In the **P/Tv/Av/M/B** shooting modes, AF is also possible by pressing the <AF-ON> button.



- If focus cannot be achieved, the focus confirmation light <●> in the viewfinder will blink. If this occurs, a picture cannot be taken even if the shutter button is pressed completely. Recompose the picture and try to focus again. Or see “When Autofocus Fails” (p.92).
- If the [**Beep**] menu is set to [**Off**], the beeper will not sound when focus is achieved.

AI Servo AF for Moving Subjects

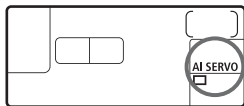

This AF mode is for moving subjects when the focusing distance keeps changing. While you hold down the shutter button halfway, the subject will be focused continuously.

- The exposure is set at the moment the picture is taken.
- In the **P/Tv/Av/M/B** shooting modes, AF is also possible by pressing the <AF-ON> button.

 With AI Servo AF, the beeper will not sound even when focus is achieved. Also, the focus confirmation light <●> in the viewfinder will not light.

AI Focus AF for Automatic Switching of AF Mode

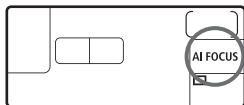

AI Focus AF switches the AF mode from One-Shot AF to AI Servo AF automatically if the still subject starts moving.

- After the subject is focused in the One-Shot AF mode, if the subject starts moving, the camera will detect the movement and change the AF mode automatically to AI Servo AF.

 When focus is achieved in the AI Focus AF mode with the Servo mode active, the beeper will sound softly. However, the focus confirmation light <●> in the viewfinder will not light.

Selecting the AF Area ☆

Default AF Area Selection Modes

As default setting, the following three AF area selection modes can be selected. See the next page for the selection procedure.

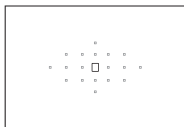

Single-point AF (Manual selection) (p.89)

Select one AF point to focus.

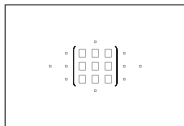

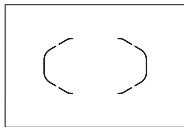

Zone AF (Manual selection of a zone) (p.90)

The 19 AF points are divided into five zones for focusing.



Auto select 19-point AF (p.90)

All the AF points are used to focus. Set in fully-automatic modes (/).

AF Area Selection Modes Added with Custom Functions

With [ C.Fn III -6: Select AF area selec. mode] (p.212), the following two AF area selection modes can be added.

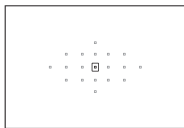

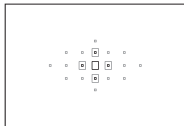

Spot AF (Manual selection) (p.89)

For pinpoint focusing.





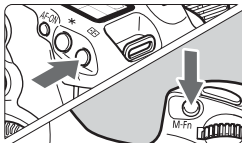

AF point expansion (Manual selection) (p.89)

The manually-selected AF point  and adjacent AF points  are used to focus.

Selecting the AF Area Selection Mode



Select the AF area selection mode.

- Press the  button. ( 6)
- Look through the viewfinder and press the  button.
- ▶ Press the  button to change the AF area selection mode. By default, the button changes the mode to single-point AF, Zone AF, and 19-point AF.

Selecting the AF Point Manually

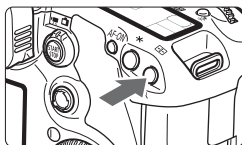





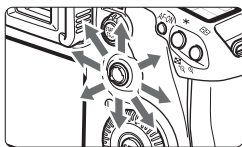

1 Press the button. (6)



- ▶ The 19 AF points will be displayed in the viewfinder.
- If Zone AF has been set, the selected zone will also be displayed.

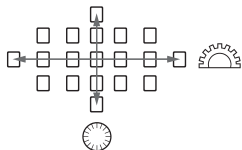

2 Select the AF point.

- The AF point selection will change in the direction you tilt the . If you press  straight down, the center AF point (or zone) will be selected.
- You can also use the  and  dials to select the AF point. The  dial selects an AF point in the horizontal direction, and the  dial selects an AF point in the vertical direction.



 With [ C.Fn III -7: Manual AF pt. selec. pattern], you can set either [0: Stops at AF area edges] or [1: Continuous] (p.212).

AF Area Selection Modes

The AF areas are explained starting with the smallest one.

(1) Spot AF (Manual selection) C.Fn III -6



Although this is the same as single-point AF, the selected AF point <□> covers a smaller pinpoint area to focus. Effective for pinpoint focusing overlapping subjects such as an animal in a cage. Since Spot AF covers a very small area, focusing might be difficult during hand-held shooting or for a moving subject.

(2) Single-point AF (Manual selection)



Select one AF point <□> to be used to focus.

(3) AF point expansion (Manual selection) C.Fn III -6

The manually-selected AF point <□> and adjacent AF points <•> are used to focus. Effective when it is difficult to track a moving subject with just one AF point.

With AI Servo AF, the manually-selected AF point <□> must focus-track the subject first. However, it is easier to focus the target subject than with Zone AF.

With One-Shot AF, when focus is achieved with the expanded AF point, the expanded AF point <□> will also be displayed along with the manually-selected AF point <□>.



(4) Zone AF (Manual selection of zone)

The 19 AF points are divided into five zones for focusing. All the AF points in the selected zone are used for the automatic selection of the AF point. It makes achieving focus easier than with single-point AF or AF point expansion and it is effective for moving subjects. However, since it is inclined to focus the nearest subject, focusing a specific target is harder than with single-point AF or AF point expansion.

With One-Shot AF, the AF point <□> which achieved focus will be displayed.



(5) 19-point AF auto selection

All the AF points are used to focus. Automatically set in fully-automatic modes (□/CA).



With One-Shot AF, pressing the shutter button halfway will display the AF point(s) <□> which achieved focus. If multiple AF points are displayed, it means they all have achieved focus. This mode tends to focus the nearest subject.



With AI Servo AF, the manually-selected (p.88) AF point <□> is used first to achieve focus. This cannot be set in fully-automatic modes (□/CA).

! With 19-point AF and Zone AF, the active AF point will keep switching to track the subject in AI Servo AF mode. However, under certain shooting conditions (such as when the subject is small), it might not be able to track the subject. Also, in low temperatures, the tracking response is slower.



- If [**C.Fn III -12: Orientation linked AF point**] is set to [**1: Select different AF points**], you can set the AF area selection mode and manually-selected AF point (or zone in the case of Zone AF) separately for vertical and horizontal shooting (p.214).
- If [**C.Fn III -10: Focus display in AI SERVO/MF**] is set to [**Disable**], the active AF points <□> during AI Servo AF will not be displayed.

AF-Assist Beam with the Built-in Flash

Under low-light conditions, when you press the shutter button halfway, the built-in flash fires a brief burst of flashes. It illuminates the subject to enable easier autofocusing.



- The built-in flash's AF-assist beam is effective up to about 4 meters/13.1 feet.
- In the **P/Tv/Av/M/B** shooting modes, press the <⚡> button to pop-up the built-in flash. Then it will fire the AF-assist beam when necessary.

Lens' Maximum Aperture and AF Sensitivity

With lenses whose maximum aperture is larger than f/5.6

With all AF points, cross-type AF sensitive to both vertical and horizontal lines is possible.

With lenses whose maximum aperture is larger than f/2.8*

With the center AF point, high-precision, cross-type AF sensitive to both vertical and horizontal lines is possible. The center AF point's sensitivity to vertical and horizontal lines is about twice as sensitive as the other AF points.

The remaining 18 AF points will work as cross-type points with lenses brighter than f/5.6.

* Except with the EF28-80mm f/2.8-4L USM and EF50mm f/2.5 Compact Macro lenses.

When Autofocus Fails

Autofocus can fail to achieve focus (the focus confirmation light <●> blinks) with certain subjects such as the following:

Subjects difficult to focus

- Very low-contrast subjects
(Example: Blue sky, solid-color walls, etc.)
- Subjects in very low light
- Extremely backlit or reflective subjects
(Example: Car with a highly reflective body, etc.)
- Near and far subjects covered by an AF point
(Example: Animal in a cage, etc.)
- Repetitive patterns
(Example: Skyscraper windows, computer keyboards, etc.)

In such cases, do one of the following:

- (1) With One-Shot AF, focus an object at the same distance as the subject and lock the focus before recomposing (p.52).
- (2) Set the lens focus mode switch to <MF> and focus manually.

MF: Manual Focusing

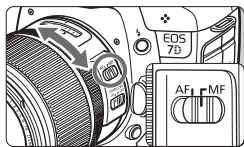

Focusing ring

1 Set the lens focus mode switch to <MF>.

2 Focus the subject.

- Focus by turning the lens focusing ring until the subject looks sharp in the viewfinder.

If you press the shutter button halfway during manual focusing, the AF point which achieved focus will be displayed and the focus confirmation light <●> will light in the viewfinder.

Selecting the Drive Mode ☆

Single and continuous drive modes are provided. In the <□> (Full Auto) mode, single shooting is set automatically.

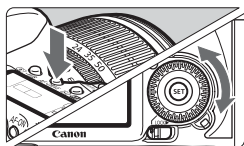

1 Press the <AF·DRIVE> button. (ⓘ6)

2 Select the drive mode.

- While looking at the LCD panel, turn the <☉> dial.

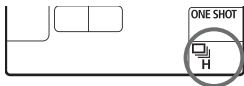

: **Single shooting**

When you press the shutter button completely, one shot will be taken.

H : **High-speed continuous shooting** (Max. 8 shots per sec.)

: **Low-speed continuous shooting** (Max. 3 shots per sec.)

While you hold down the shutter button completely, shots will be taken continuously.

ⓐ : **10-sec. self-timer/Remote control**

ⓑ : **2-sec. self-timer/Remote control**

For self-timer shooting, see the next page. For remote control shooting, see page 110.



- When the battery level is low, the continuous shooting speed will be slightly slower.
- In the AI Servo AF mode, the continuous shooting speed may become slightly slower depending on the subject and the lens used.
- In low-light areas or indoors, the continuous shooting speed may become slower even if a fast shutter speed is set.

Using the Self-timer

Use the self-timer when you want to be in the picture. The  (10 sec. timer) can be used in all shooting modes.

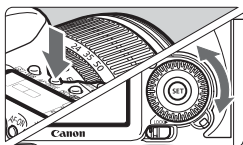

1 Press the <AF•DRIVE> button. ()

2 Select the self-timer.

- Look at the LCD panel and turn the  dial to select the self-timer.

 : **10-sec. self-timer**

 : **2-sec. self-timer**★

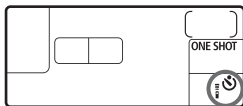

3 Take the picture.

- Look through the viewfinder, focus the subject, then press the shutter button completely.
- ▶ You can check the self-timer operation with the self-timer lamp, beeper, and countdown display (in seconds) on the LCD panel.
- ▶ Two seconds before the picture is taken, the self-timer lamp will stay on and the beeper will sound faster.

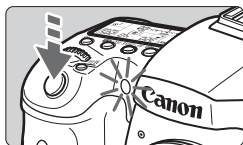

- The  2-sec. self-timer enables you to shoot while not touching the camera mounted on a tripod. This prevents camera shake while you shoot still lifes or bulb exposures.
- After taking self-timer shots, you should check the image for proper focus and exposure (p.162).
- If you will not look through the viewfinder when you press the shutter button, attach the eyepiece cover (p.108). If stray light enters the viewfinder when the picture is taken, it may throw off the exposure.
- When using the self-timer to shoot only yourself, use focus lock (p.52) for an object at about the same distance as where you will be.
- To cancel the self-timer after it starts, press the **<AF•DRIVE>** button.

5

Advanced Operations

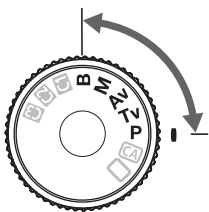

In the **P/Tv/Av/M/B** shooting modes, you can select the shutter speed, aperture, and other camera settings to change the exposure and obtain the desired result.

- The ☆ icon on the right of the page title indicates that the function can be used when the Mode Dial is set to <**P/Tv/Av/M/B**>.
- After you press the shutter button halfway and let go, the LCD panel and viewfinder information will remain displayed for about 4 sec. (🔍4).
- Functions which can be set in the **P/Tv/Av/M/B** shooting modes are listed in “Function Availability Table” (p.236).



Be sure to first set the Quick Control Dial switch to <🔍>.

P: Program AE

The camera automatically sets the shutter speed and aperture to suit the subject's brightness. This is called Program AE.

* <P> stands for Program.

* AE stands for Auto Exposure.



1 Set the Mode Dial to <P>.



2 Focus the subject.

- Look through the viewfinder and aim the selected AF point over the subject. Then press the shutter button halfway.
- ▶ When focus is achieved, the focus confirmation light <●> on the viewfinder's bottom right will light (One-Shot AF mode).
- ▶ The shutter speed and aperture will be set automatically and displayed in the viewfinder and on the LCD panel.



3 Check the shutter speed and aperture display.

- A correct exposure will be obtained as long as the shutter speed and aperture display do not blink.



4 Take the picture.

- Compose the shot and press the shutter button completely.

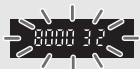

- If the "30''" shutter speed and the maximum aperture blink, it indicates underexposure. Increase the ISO speed or use flash.
- If the "8000" shutter speed and the minimum aperture blink, it indicates overexposure. Lower the ISO speed or use an ND filter (sold separately) to reduce the amount of light entering the lens.



Differences Between <P> and <□> (Full Auto)

With <□>, many functions such the AF mode, drive mode, and built-in flash are set automatically to prevent spoiled shots. The functions you can set are limited. With <P>, only the shutter speed and aperture are set automatically. You can freely set the AF mode, drive mode, built-in flash, and other functions (p.236).

About Program Shift

- In the Program AE mode, you can freely change the shutter speed and aperture combination (Program) set by the camera while maintaining the same exposure. This is called Program shift.
- To do this, press the shutter button down halfway, then turn the <☀> dial until the desired shutter speed or aperture value is displayed.
- Program shift is canceled automatically after the picture is taken.
- Program shift cannot be used with flash.

Tv: Shutter-Priority AE

In this mode, you set the shutter speed and the camera automatically sets the aperture to obtain the correct exposure suiting the brightness of the subject. This is called shutter-priority AE. A faster shutter speed can freeze the action or moving subject. Or a slower shutter speed can create a blurred effect, giving the impression of motion.

* <Tv> stands for Time value.



Frozen action
(Fast shutter speed)



Blurred motion
(Slow shutter speed)



1 Set the Mode Dial to <Tv>.

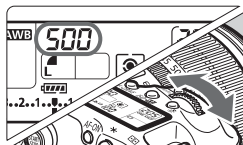

2 Set the desired shutter speed.

- While looking at the LCD panel, turn the  dial.

3 Focus the subject.

- Press the shutter button halfway.
- ▶ The aperture is set automatically.



4 Check the viewfinder display and shoot.

- As long as the aperture is not blinking, the exposure will be correct.



- If the maximum aperture blinks, it indicates underexposure. Turn the <  > dial to set a slower shutter speed until the aperture stops blinking or set a higher ISO speed.



- If the minimum aperture blinks, it indicates overexposure. Turn the <  > dial to set a faster shutter speed until the aperture stops blinking or set a lower ISO speed.



Shutter Speed Display

The shutter speeds from “8000” to “4” indicate the denominator of the fractional shutter speed. For example, “125” indicates 1/125 sec. Also, “0”5” indicates 0.5 sec. and “15” is 15 sec.

Av: Aperture-Priority AE

In this mode, you set the desired aperture and the camera sets the shutter speed automatically to obtain the correct exposure suiting the subject brightness. This is called aperture-priority AE. A higher $f/$ number (smaller aperture hole) will make more of the foreground and background fall within acceptable focus. On the other hand, a lower $f/$ number (larger aperture hole) will make less of the foreground and background fall within acceptable focus.

* <Av> stands for Aperture value (aperture opening).



Sharp foreground and background
(With a small aperture opening)



Blurred background
(With a large aperture opening)



1 Set the Mode Dial to <Av>.

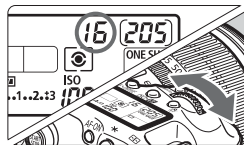

2 Set the desired aperture.

- While looking at the LCD panel, turn the  dial.

3 Focus the subject.

- Press the shutter button halfway.
- ▶ The shutter speed is set automatically.



4 Check the viewfinder display and shoot.

- As long as the shutter speed is not blinking, the exposure will be correct.



- If the “30” shutter speed blinks, it indicates underexposure. Turn the dial to set a larger aperture (smaller f /number) until the blinking stops or set a higher ISO speed.



- If the “8000” shutter speed blinks, it indicates overexposure. Turn the dial to set a smaller aperture (larger f /number) until the blinking stops or set a lower ISO speed.



Aperture Display

The larger the f /number, the smaller the aperture opening will be. The apertures displayed will differ depending on the lens. If no lens is attached to the camera, “00” will be displayed for the aperture.

Depth of Field Preview [☆]

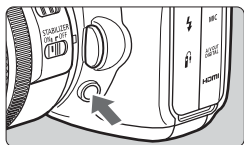

Press the depth-of-field preview button to stop down the lens to the current aperture setting. You can check the depth of field (range of acceptable focus) through the viewfinder.



- A higher f /number will make more of the foreground and background fall within acceptable focus. However, the viewfinder will look darker.
- The depth-of-field effect can be clearly seen on the Live View image as you change the aperture and press the depth-of-field preview button (p.132).
- The exposure will be locked (AE lock) while the depth-of-field preview button is pressed.

M: Manual Exposure

In this mode, you set both the shutter speed and aperture as desired. To determine the exposure, refer to the exposure level indicator in the viewfinder or use a commercially-available handheld exposure meter. This method is called manual exposure.

* <M> stands for Manual.



1 Set the Mode Dial to <M>.

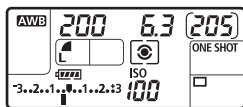

2 Set the shutter speed and aperture.

- To set the shutter speed, turn the <☀> dial.
- To set the aperture, set the Quick Control Dial switch to <∠>, and turn the <☉> dial.

Standard exposure index



Exposure level mark

3 Focus the subject.

- Press the shutter button halfway.
- ▶ The exposure setting will be displayed in the viewfinder and on the LCD panel.
- The exposure level mark <∣> lets you see how far you are from the standard exposure level.

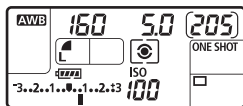



4 Set the exposure.

- Check the exposure level and set the desired shutter speed and aperture.

5 Take the picture.

⚠ If the [☑] **Auto Lighting Optimizer** (p.75) is set to anything other than [Disable], the image may still look bright even if a darker exposure has been set.

Selecting the Metering Mode ☆

You can select one of four methods to measure the subject brightness. In fully-automatic modes (/), evaluative metering is set automatically.

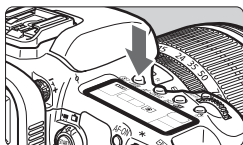

1 Press the **·WB> button.** ()

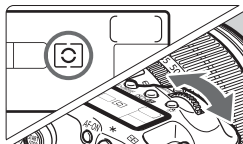

2 Select the metering mode.

- While looking at the LCD panel, turn the  dial.

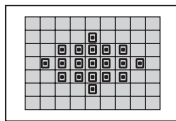

Evaluative metering

This is a general-purpose metering mode suited for portraits and even backlit subjects. The camera sets the exposure automatically to suit the scene.



Partial metering

Effective when the background is much brighter than the subject due to backlighting, etc. Partial metering covers about 9.4% of the viewfinder area at the center.

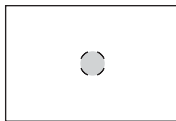

Spot metering

This is for metering a specific spot of the subject or scene. The metering is weighted at the center covering about 2.3% of the viewfinder area. When spot metering is set, the spot metering circle will be displayed in the viewfinder.



Center-weighted average metering

The metering is weighted at the center and then averaged for the entire scene.

Setting Exposure Compensation ☆

Exposure compensation can increase (brighter) or decrease (darker) the standard exposure set by the camera.

Although you can set the exposure compensation up to ± 5 stops in 1/3-stop increments, the exposure compensation indicator on the LCD panel and in the viewfinder can only display the setting up to ± 3 stops. If you want to set the exposure compensation setting beyond ± 3 stops, you should follow the instructions for [☐ Exp. comp./AEB] on the next page.



1 Set the Mode Dial to <P>, <Tv>, or <Av>.

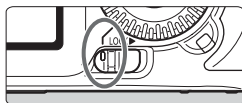

2 Set the Quick Control Dial switch to <←>.

Increased exposure for a brighter image



3 Set the exposure compensation amount.



- After pressing the shutter button halfway (☑4), turn the <☉> dial.

Decreased exposure for a darker image



4 Take the picture.

- To cancel the exposure compensation, set the exposure compensation amount back to <☉>.

☑ If the [☐ Auto Lighting Optimizer] (p.75) is set to anything other than [Disable], the image may still look bright even if a darker exposure has been set.

- The exposure compensation amount will remain in effect even after you set the power switch to <OFF>.
- Be careful not to turn the <☉> dial and change the exposure compensation inadvertently. To prevent this, set the Quick Control Dial switch to <LOCK▶>.
- If the amount set exceeds ± 3 stops, the end of the exposure level indicator will display <◀> or <▶>.

Auto Exposure Bracketing (AEB) ☆

By changing the shutter speed or aperture automatically, the camera brackets the exposure up to ± 3 stops in 1/3-stop increments for three successive shots. This is called AEB.

* AEB stands for Auto Exposure Bracketing.

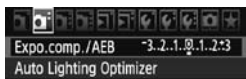



1 Select [Expo. comp./AEB].

- Under the [] tab, select [Expo. comp./AEB], then press <SET>.



2 Set the AEB amount.

- Turn the < > dial to set the AEB amount.
- You can set the exposure compensation amount with the < > dial. If AEB is combined with exposure compensation, AEB will be applied centering on the exposure compensation amount.
- Press <SET> to set it.
- ▶ When you exit the menu, < > and the AEB level will be displayed on the LCD panel.

AEB amount

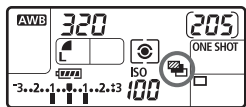





3 Take the picture.

- Focus and press the shutter button completely. The three bracketed shots will be taken in this sequence: Standard, decreased exposure, and increased exposure.

Canceling AEB

- Follow steps 1 and 2 to turn off the AEB amount display.
- AEB will be canceled automatically when you set the power switch to <OFF> or when the flash is ready to fire.



- If the drive mode is set to < >, you must press the shutter button three times. When < > or < > is set and you hold down the shutter button completely, the three bracketed shots will be taken continuously. Then the camera will stop shooting. When < > or < > is set, the three bracketed shots will be taken continuously after a 10-sec. or 2-sec. delay.
- Neither flash nor bulb exposures can be used with AEB.

* AE Lock ☆

Use AE lock when the area of focus is to be different from the exposure metering area or when you want to take multiple shots at the same exposure setting. Press the < * > button to lock the exposure, then recompose and take the shot. This is called AE lock. It is effective for backlit subjects.

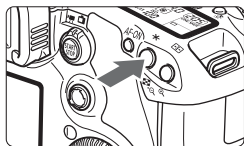

1 Focus the subject.

- Press the shutter button halfway.
- ▶ The exposure setting will be displayed.

2 Press the < * > button. (⦿4)

- ▶ The < * > icon lights in the viewfinder to indicate that the exposure setting is locked (AE lock).
- Each time you press the < * > button, it locks the current auto exposure setting.





3 Recompose and take the picture.

- If you want to maintain the AE lock while taking more shots, hold down the < * > button and press the shutter button to take another shot.



AE Lock Effects

Metering Mode (p.103)	AF Point Selection Method (p.87)	
	Automatic Selection	Manual Selection
	AE lock is applied at the AF point that achieved focus.	AE lock is applied at the selected AF point.
	AE lock is applied at the center AF point.	

* When the lens' focus mode switch is set to <MF>, AE lock is applied at the center AF point.

B: Bulb Exposures

When bulb is set, the shutter stays open while you hold down the shutter button completely, and closes when you let go of the shutter button. This is called bulb exposure. Use bulb exposures for night scenes, fireworks, the heavens, and other subjects requiring long exposures.



1 Set the Mode Dial to .

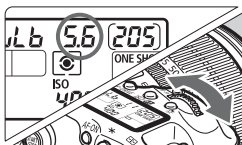

2 Set the desired aperture.

- While looking at the LCD panel, turn the <A> or <D> dial.

3 Take the picture.

- While you hold down the shutter button, the exposure will continue.
- ▶ The elapsed exposure time will be displayed on the LCD panel.

Elapsed exposure time



- Since bulb exposures produce more noise than usual, the image might look a little grainy.
- When [C.Fn II -1: Long exp. noise reduction] is set to [1: Auto] or [2: On], noise generated by the bulb exposure can be reduced (p.208).



- For bulb exposures, using the Remote Switch RS-80N3 or Timer Remote Controller TC-80N3 (both sold separately) is recommended.
- You can also use a remote controller (sold separately, p.110) for bulb exposures. When you press the remote controller's transmit button, the bulb exposure will start immediately or 2 sec. later. Press the button again to stop the bulb exposure.

Using the Eyepiece Cover

If you take a picture without looking at the viewfinder, light entering the eyepiece can throw off the exposure. To prevent this, use the eyepiece cover (p.23) attached to the camera strap. During Live View shooting and movie shooting, attaching the eyepiece cover is unnecessary.

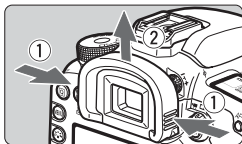

1 Remove the eyecup.

- While grasping both sides of the eyecup, slide it upward to remove.

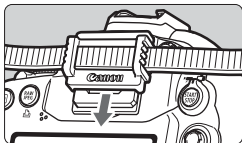

2 Attach the eyepiece cover.

- Slide the eyepiece cover down into the eyepiece groove to attach it.

Connecting the Remote Switch

You can connect the Remote Switch RS-80N3 or Timer Remote Controller TC-80N3 (both sold separately) or any EOS accessory equipped with an N3-type terminal to the camera and shoot with it. To operate the accessory, refer to its instruction manual.

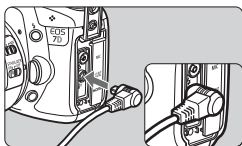

1 Open the terminal cover.

2 Connect the plug to the remote control terminal.

- Connect the plug as shown in the illustration.
- To disconnect the plug, grasp the plug's silver part and pull out.

Mirror Lockup [☆]

Although using the self-timer or Remote Switch can prevent camera shake, using mirror lockup to prevent camera vibrations (mirror shock) can also help when you use a super telephoto lens or shoot close ups.

When [C.Fn III -13: Mirror lockup] is set to [1: Enable] (p.215), shooting with mirror lockup will be possible.

1 Focus the subject, press the shutter button completely and let go of it.

- ▶ The mirror will swing up.

2 Press the shutter button completely again.

- ▶ The picture is taken and the mirror goes back down.



- In very bright light such as at the beach or ski slope on a sunny day, take the picture promptly after mirror lockup.
- Do not point the camera toward the sun. The sun's heat can scorch and damage the shutter curtains.
- If you use bulb exposures, the self-timer, and mirror lockup in combination, keep pressing the shutter button completely (self-timer delay time + bulb exposure time). If you let go of the shutter button during the self-timer countdown, there will be a shutter-release sound. However, this is not the actual shutter release (no picture is taken).



- When [1: Enable] is set, single shooting will take effect even if the drive mode is set to continuous.
- When the self-timer is set to or , the picture will be taken after 10 sec. or 2 sec. respectively.
- The mirror locks up, and after 30 seconds, it will go back down automatically. Pressing the shutter button completely again locks up the mirror again.
- For mirror lockup shots, using the Remote Switch RS-80N3 or Timer Remote Controller TC-80N3 (both sold separately) is recommended.
- You can also lockup the mirror and shoot with a remote controller (sold separately, p.110). With Remote Controller RC-1, setting it to a 2-sec. delay is recommended for shooting.

Remote Control Shooting



RC-1



RC-5

With Remote Controller RC-1 or RC-5 (both sold separately), you can shoot remotely up to about 5 meters/16.4 feet from the camera. RC-1 enables you to shoot immediately or after a 2-sec. delay, and RC-5 has a 2-sec. delay.

1 Focus the subject.

2 Set the lens focus mode switch to <MF>.

- You can also shoot with <AF>.

3 Press the <AF•DRIVE> button. (ⓘ6)

4 Select the self-timer.

- Look at the LCD panel and turn the <⌚> dial to select <ⓘ⌚> or <ⓘ⌚2>.

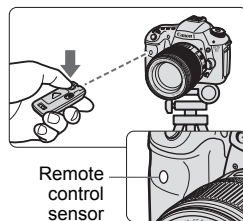
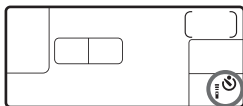
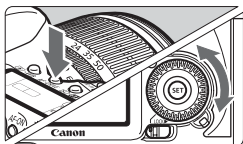

5 Press the remote controller's transmit button.

- Point the remote controller toward the camera's remote control sensor and press the transmit button.
- ▶ The self-timer lamp lights and the picture is taken.

! Camera misoperation may occur near certain types of fluorescent lights. During wireless remote control, try to keep the camera away from fluorescent light sources.

⚡ Using the Built-in Flash

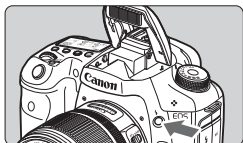

In the **P/Tv/Av/M/B** shooting modes, you can press the **<⚡>** button to pop-up and fire the built-in flash whenever desired. If the built-in flash has popped up, you can push it back down with your fingers. In the **<□>** (Full Auto) mode, the built-in flash fires automatically (p.50). In the **<CA>** mode, you can set it to fire automatically or manually (p.53).

Using flash in the **P/Tv/Av/M/B** shooting modes will set the shutter speed and aperture as shown below. In any shooting mode, E-TTL II autoflash control will take effect to suit the manually- or automatically-set aperture.

Shooting Mode	Shutter Speed	Aperture
P	Automatically set within 1/250 sec. - 1/60 sec.	Automatically set
Tv	Manually set within 1/250 sec. - 30 sec.	Automatically set
Av	Automatically set With [C.Fn I -7: Flash sync. speed in Av mode] (p.207), the following options for automatic selection can be selected: <ul style="list-style-type: none">• 0: Auto*• 1: 1/250 - 1/60 sec. auto• 2: 1/250 sec. (fixed)	Set manually
M	Manually set within 1/250 sec. - 30 sec.	Set manually
B	While you hold down the shutter button, the exposure will continue.	Set manually

* Normally, the sync speed is set automatically within 1/250 sec. to 30 sec. to suit the ambient brightness. In low light, the main subject is exposed with the automatic flash, and the background is exposed with a slow shutter speed set automatically. Both the subject and background look properly exposed (automatic slow-speed flash sync). With slow shutter speeds, using a tripod is recommended.

Effective Range of Built-in Flash

[Approx. meters/feet]

Aperture	ISO Speed							
	100	200	400	800	1600	3200	6400	H: 12800
f/3.5	3.5 / 12	5 / 16	7 / 23	9.5 / 31	14 / 46	19 / 62	27 / 89	39 / 128
f/4	3 / 10	4 / 13	6 / 20	8.5 / 28	12 / 39	17 / 56	24 / 79	34 / 112
f/5.6	2 / 7	3 / 10	4.5 / 15	6 / 20	8.5 / 28	12 / 39	17 / 56	24 / 79



- For close subjects, the subject should be at least 1 meter/3.3 feet away when using flash.
- Detach the lens hood and keep at least 1 meter/3.3 feet away from the subject.
- If the lens has a hood attached or you are too close to the subject, the bottom of the picture might look dark due to the obstructed flash. If you use a telephoto lens or a fast lens and the built-in flash is still partially obstructed, use an EX-series Speedlite (sold separately).

MENU Using Red-eye Reduction

Using the red-eye reduction lamp before taking a flash picture can reduce red eye.

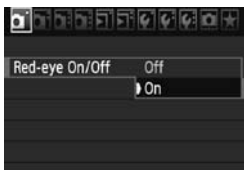

- Under the [] tab, select [**Red-eye On/Off**], then press <SET>. Select [**On**], then press <SET>.
- For flash photography, when you press the shutter button halfway, the red-eye reduction lamp will light. Then when you press the shutter button completely, the picture will be taken.



- The red-eye reduction feature is most effective when the subject looks at the red-eye reduction lamp, when the room is well lit, or when you go closer to the subject.
- When you press the shutter button halfway, the display on the viewfinder bottom will gradually turn off. For best results, take the picture after this display turns off.
- The effectiveness of red-eye reduction varies depending on the subject.



Flash Exposure Compensation ☆

In the same way as normal exposure compensation, you can set exposure compensation for flash. You can set flash exposure compensation up to ± 3 stops in 1/3-stop increments.



1 Press the **<ISO-FEC>** button. (ⓘ6)

Increased exposure



Decreased exposure



2 Set the flash exposure compensation amount.

- While looking at the LCD panel or viewfinder, turn the **<Q>** dial.
- To cancel the flash exposure compensation, set the flash exposure compensation amount back to **<0>**.
- When you press the shutter button halfway, the **<FEC>** icon will be displayed in the viewfinder and on the LCD panel.

3 Take the picture.

- If the **[Auto Lighting Optimizer]** (p.75) is set to anything other than **[Disable]**, the image may still look bright even if a darker flash exposure has been set.
- If you set flash exposure compensation with both the camera and EX-series Speedlite, the Speedlite's flash exposure compensation setting will override the camera's. If you set flash exposure compensation with an EX-series Speedlite, any flash exposure compensation set with the camera will not take effect.



- The exposure compensation amount will remain in effect even after you set the power switch to **<OFF>**.
- The camera can also be used to set the EX-series Speedlite's flash exposure compensation in the same way as with the Speedlite.

M-Fn: FE Lock ☆

FE (flash exposure) lock obtains and locks the correct flash exposure reading for any part of a subject.

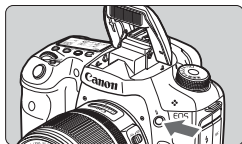

1 Press the <⚡> button to pop-up the built-in flash.

- Press the shutter button halfway and look in the viewfinder to check that the <⚡> icon is lit.



2 Focus the subject.

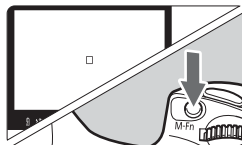

3 Press the <M-Fn> button. (ⓘ16)

- Aim the viewfinder center over the subject where you want to lock the flash exposure, then press the <M-Fn> button.
- ▶ The flash will fire a preflash and the required flash output is calculated and retained in memory.
- ▶ In the viewfinder, “FEL” is displayed for a moment and <⚡*> will light.
- Each time you press the <M-Fn> button, a preflash is fired and the required flash output is calculated and retained in memory.



4 Take the picture.

- Compose the shot and press the shutter button completely.
- ▶ The flash is fired to take the picture.



⚠ If the subject is too far away and beyond the effective range of the flash, the <⚡> icon will blink. Get closer to the subject and repeat steps 2 to 4.

MENU Setting the Flash ☆

The built-in flash and external Speedlite settings can be set with the menu. The [External flash ***] menu options for external Speedlites are applicable only to an attached **EX-series Speedlite compatible with the respective functions**.

The setting procedure is the same as setting a camera menu function.

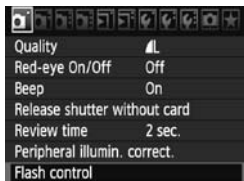

Select [Flash control].

- Under the [] tab, select [Flash control], then press <SET>.
- ▶ The flash control screen will appear.

[Flash firing]

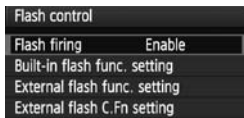

- Normally, set this to [Enable].
- If [Disable] is set, both the built-in flash and external Speedlite will not fire. This is useful when you only want to use the AF-assist beam.

[Built-in flash func. setting] and [External flash func. setting]

The [Built-in flash func. setting] and [External flash func. setting] menus can set the functions listed on the next page. The functions displayed under [External flash func. setting] will vary depending on the Speedlite model.

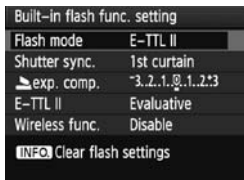

- Select [Built-in flash func. setting] or [External flash func. setting].
- ▶ The flash functions will be displayed. The functions not dimmed can be selected and set.

[Built-in flash func. setting] and [External flash func. setting] Settable Functions

Function	[Built-in flash func. setting]	[External flash func. setting]	Page
Flash mode		○	116
Shutter sync.		○	117
FEB*	–	○	–
Flash exposure compensation		○	113
E-TTL II		○	117
Zoom*	–	○	–
Wireless setting		○	119

* Regarding the **[FEB]** (Flash exposure bracketing) and **[Zoom]**, refer to the Speedlite's instruction manual.

● **Flash mode**

You can select the flash mode to suit your desired flash shooting.

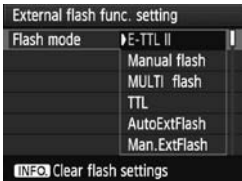
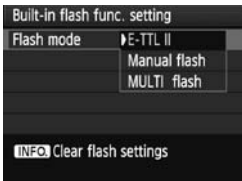

- **[E-TTL II]** is the standard mode of EX-series Speedlites for automatic flash shooting.
- **[Manual flash]** is for advanced users who want to set the **[Flash output]** (1/1 to 1/128) themselves.
- **[MULTI flash]** is for advanced users who want to set the **[Flash output]**, **[Frequency]**, and **[Flash count]** themselves.
- Regarding other flash modes, refer to your Speedlite's instruction manual.



To prevent the flash from overheating and degrading, avoid firing the MULTI flash more than 10 consecutive times. If you fire the flash 10 times, allow the flash to rest for at least 10 min. before firing the flash again. Some EX-series Speedlites will automatically stop firing after 10 times to protect the flash. If this happens, let the flash rest for at least 15 min.

- **Shutter sync.**

Normally, set this to **[1st curtain]** so that the flash fires immediately after the exposure starts.

If **[2nd curtain]** is set, the flash will fire right before the exposure ends. When this is combined with a slow sync speed, you can create a trail of light such as from car headlights at night. With 2nd curtain sync, two flashes will be fired, once when you press the shutter button completely, and once immediately before the exposure ends. However, with shutter speeds faster than 1/30 sec., the 1st curtain sync will automatically take effect.

If an external Speedlite is attached, you can also set **[Hi-speed]**. For details, see the Speedlite's instruction manual.

- **Flash exposure compensation**

See “ Flash Exposure Compensation” on page 113.

- **E-TTL II**

For normal flash exposures, set it to **[Evaluative]**.

If **[Average]** is set, the flash exposure will be averaged for the entire metered scene as with an external metering flash. Since flash exposure compensation may be necessary depending on the scene, this setting is for advanced users.

- **Wireless setting**

See “Using Wireless Flash” on page 119.

- **Clear flash settings**

With the **[Built-in flash func. setting]** or **[External flash func. setting]** screen displayed, press the <INFO.> button to display the screen to clear the flash settings. When you select **[OK]**, the settings for the flash will be cleared.

Setting the External Speedlite Custom Functions

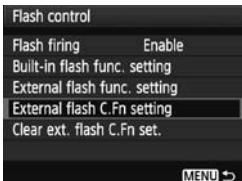

1 Display the Custom Function.

- Select [**External flash C.Fn setting**], then press <  >.

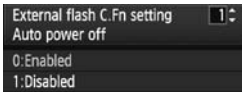

2 Set the Custom Function.

- Turn the <  > dial to select the function number, then set the function. The procedure is the same as setting the camera's Custom Functions (p.204).
- To clear all the Custom Function settings, select [**Clear ext. flash C.Fn set.**] in step 1.

Fully Automatic Shooting with One External Speedlite

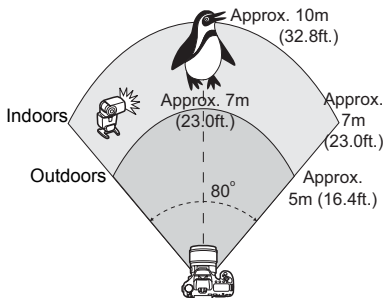

This shows the most basic setup for fully-automatic wireless flash with one Speedlite.

Steps 1 to 3 and 6 to 8 apply to all wireless flash shooting. Therefore, these steps are omitted in the other wireless flash setups explained on the following pages.

On the menu screens, the < > and < > icons refer to the external Speedlite, and the < > and < > icons refer to the built-in flash.

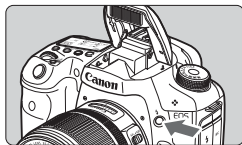

1 Press the button to pop-up the built-in flash.

- For wireless flash, be sure to pop-up the built-in flash.

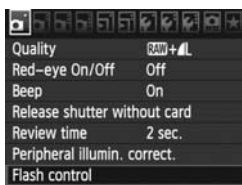

2 Select [Flash control].

- Under the [] tab, select [Flash control], then press < >.

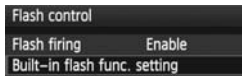

3 Select [Built-in flash func. setting].

- Select [Built-in flash func. setting], then press < >.

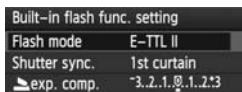

4 Select [Flash mode].

- For [Flash mode], select [E-TTL II], then press < >.

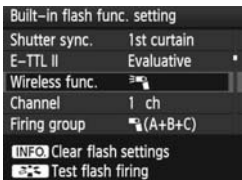

5 Select [Wireless func.].

- For [Wireless func.], select [Wireless func. icon], then press <SET>.
- ▶ Under [Wireless func.], [Channel], etc., will be displayed.

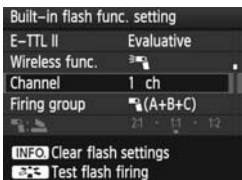

6 Set [Channel].

- Set the channel (1-4) to the same one as the slave unit.



7 Fire a test flash.

- After checking that the slave unit is ready to fire, go to the screen in step 5 and press the <Test flash firing> button.
- ▶ The slave unit will fire. If it does not fire, check your settings again (p.119).

8 Take the picture.

- Set the camera and take the picture as you would with normal flash shooting.
- To terminate wireless flash shooting, set [Wireless func.] to [Disable].



- Test flash can also be used to wake up slave units from auto power off.
- Setting [E-TTL II] to [Evaluative] is recommended.
- If you use only one external Speedlite, the [Firing group] setting does not have any effect.
- The slave unit is controlled by the built-in flash's light pulse signal.
- **Wireless flash will not work if the [Flash mode] is set to [MULTI flash].**

Fully-automatic Shooting with One External Speedlite and Built-in Flash

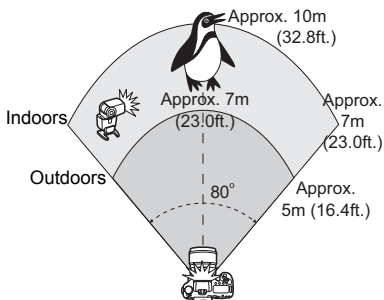

This shows fully-automatic wireless flash shooting with one external Speedlite and the built-in flash.

You can change the flash ratio between the external Speedlite and built-in flash to adjust how the shadows look on the subject.

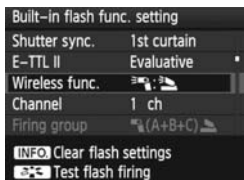

1 Select [Wireless func.].

- Follow step 5 on page 121 to select [: >] for [Wireless func.], then press <SET>.

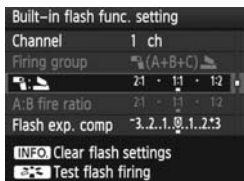

2 Set the desired flash ratio and shoot.

- Select [: >] and set the flash ratio within 8:1 to 1:1. Setting a flash ratio to the right of 1:1 (up to 1:8) is not possible.
- If the flash output is inadequate, set a higher ISO speed (p.62).

The 8:1 to 1:1 flash ratio is equivalent to 3:1 to 1:1 stops (1/2-stop increments).

Fully-automatic Shooting with Multiple External Speedlites

Multiple Speedlite slave units can be treated as one flash unit or separated into slave groups whose flash ratio can be set.

The basic settings are shown below. By changing the **[Firing group]** setting, you can shoot with various wireless flash setups with multiple Speedlites.

Built-in flash func. setting	
Flash mode	E-TTL II
Shutter sync.	1st curtain
E-TTL II	Evaluative
Wireless func.	
Channel	1 ch
INFO Clear flash settings	
Test flash firing	

Basic settings:

Flash mode	: E-TTL II
E-TTL II	: Evaluative
Wireless func.	:
Channel	: (Same as slave units)

(A+B+C) Using multiple slave Speedlites as one flash unit

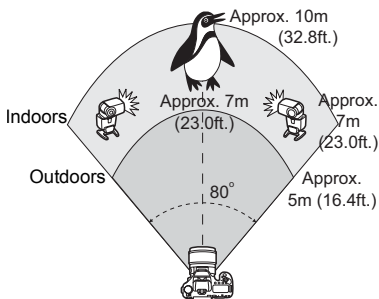

Convenient when you need a large flash output. All the slave Speedlites will fire at the same output and controlled to obtain a standard exposure. No matter what the slave ID is (A, B, or C), all the slave units will fire as one group.

Built-in flash func. setting	
Wireless func.	
Channel	1 ch
Firing group	(A+B+C)
	21 · 13 · 12
A:B fire ratio	21 · 13 · 12
INFO Clear flash settings	
Test flash firing	

Set **[Firing group]** to **(A+B+C)**, then shoot.

[A:B] Multiple slave units in multiple groups

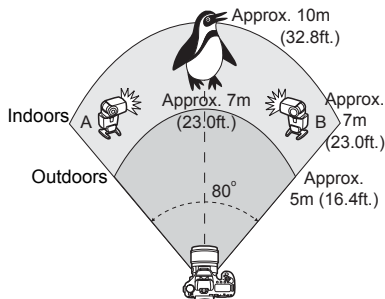

Divide the slave units into groups A and B, and change the flash ratio to obtain the desired lighting effect.

Refer to your Speedlite's instruction manual to set one slave unit's slave ID to A (Group A) and the other slave unit's ID to B (Group B) and position them as shown in the illustration.

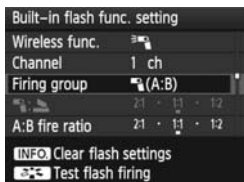

1 Set [Firing group] to [A:B].



2 Set the desired flash ratio and shoot.

- Select [A:B fire ratio] and set the flash ratio.

The 8:1 to 1:1 to 1:8 flash ratio is equivalent to 3:1 to 1:1 to 1:3 stops (1/2-stop increments).

[(A:B C)] Multiple slave units in multiple groups

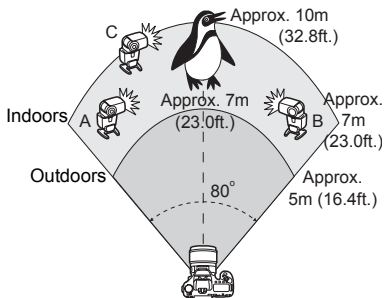

This is a variant of the [(A:B)] setup on the preceding page. This setup has group C eliminate the shadows created by groups A and B. Refer to your Speedlite's instruction manual to set the slave ID of the three slave units to A (Group A), B (Group B), and C (Group C) and position them as shown in the illustration.

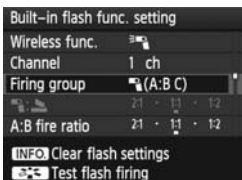

1 Set [Firing group] to [(A:B C)].



2 Set the desired flash ratio and shoot.

- Select [A:B fire ratio] and set the flash ratio.
- Set flash exposure compensation for group C as necessary.



- If [Firing group] is set to [(A:B)], group C will not fire.
- If group C is pointed toward the main subject, overexposure may result.

Fully-automatic Shooting with the Built-in Flash and Multiple External Speedlites

The built-in flash can also be added to wireless flash shooting explained on pages 119-125.

The basic settings are shown below. By changing the **[Firing group]** setting, you can shoot with various wireless flash setups of multiple Speedlites complemented with the built-in flash.

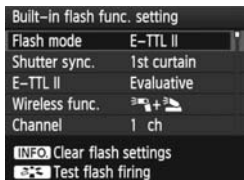

1 Basic settings:

Flash mode : E-TTL II
E-TTL II : Evaluative
Wireless func. : [Flash icon] + [Slave icon]
Channel : (Same as slave units)

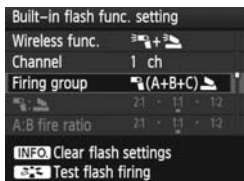

2 Select [Firing group].

- Select the firing group, then set the flash ratio, flash exposure compensation, and other necessary settings before shooting.

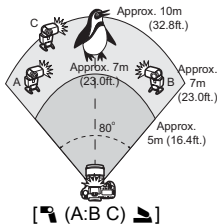
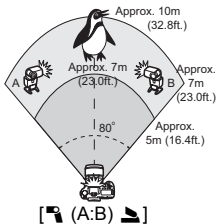
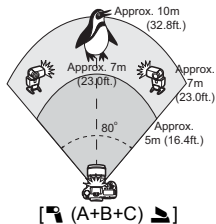

Creative Wireless Flash Shooting

Flash Exposure Compensation

When **[Flash mode]** is set to **[E-TTL II]**, flash exposure compensation can be set. The flash exposure compensation settings (see below) which can be set will differ depending on the **[Wireless func.]** and **[Firing group]** settings.

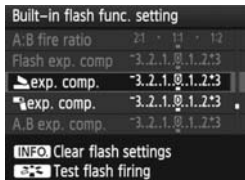

[Flash exp. comp]

- The flash exposure compensation is applied to the built-in flash and all external Speedlites.

[exp. comp.]

- The flash exposure compensation is applied to the built-in flash.

[exp. comp.]

- The flash exposure compensation is applied to all external Speedlites.

[A,B exp. comp.]

- The flash exposure compensation is applied to both groups A and B.

[Grp.C exp. comp]

- The flash exposure compensation is applied to group C.

FE lock

If **[Flash mode]** is set to **[E-TTL II]**, you can press the **<M-Fn>** button to set FE lock.

Setting the Flash Output Manually for Wireless Flash

When **[Flash mode]** is set to **[Manual flash]**, the flash output can be set manually. The flash output settings (**[Flash output]**, **[Group A output]**, etc.) that can be set will differ depending on the **[Wireless func.]** setting (see below).

Built-in flash func. setting	
Flash mode	Manual flash
Shutter sync.	1st curtain
Wireless func.	☰
Channel	1 ch
Flash output	1/4 . . 1/2 . . 1/1
INFO Clear flash settings Test flash firing	

[☰]

- The flash output set manually is applied to all external Speedlites.

[☰ (A,B,C)]

- The flash output can be set manually and individually for each group (A, B, and C) of external Speedlites.

[☰ + ☰]

- The flash output can be set manually and individually for external Speedlite and for the built-in flash.

[☰ (A,B,C) ☰]

- The flash output can be set manually and individually for each group (A, B, and C) of external Speedlites and the built-in flash.

External Speedlites

EOS-dedicated, EX-series Speedlites

Basically operates like a built-in flash for easy operation.

When an EX-series Speedlite (sold separately) is attached to the camera, almost all the autoflash control is done by the camera. In other words, it is like a high-output flash attached externally in place of the built-in flash.

For detailed instructions, **see the EX-series Speedlite's instruction manual**. This camera is a Type-A camera that can use all the features of EX-series Speedlites.



Shoe-mount Speedlites



Macro Lites



- With an EX-series Speedlite not compatible with flash function settings (p.115), only **[Flash exp. comp]** and **[E-TTL II]** can be set for **[External flash func. setting]**.
(Certain EX-series Speedlites also enable **[Shutter sync.]** to be set.)
- If the flash metering mode is set to TTL autoflash with the Speedlite's Custom Function, the flash will fire at full output only.

Canon Speedlites other than the EX-series

- **With an EZ/E/EG/ML/TL-series Speedlite set in TTL or A-TTL autoflash mode, the flash can be fired at full output only.** Set the camera's shooting mode to **<M>** (manual exposure) or **<Av>** (aperture-priority AE) and adjust the aperture setting before shooting.
- When using a Speedlite which has manual flash mode, shoot in the manual flash mode.

Using Non-Canon Flash Units

Sync Speed

The camera can synchronize with non-Canon compact flash units at 1/250 sec. and slower speeds. With large studio flash units, since the flash duration is longer than compact flash units, set the sync speed within 1/60 sec. to 1/30 sec. Be sure to test the flash synchronization before shooting.

PC Terminal

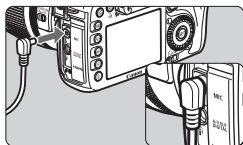

- The camera's PC terminal can be used with flash units having a sync cord. The PC terminal is threaded to prevent inadvertent disconnection.
- The camera's PC terminal has no polarity. You can connect any sync cord regardless of its polarity.

Cautions for Live View shooting

If you use a non-Canon flash with Live View shooting, set [**☑**: **Silent shoot.**] to [**Disable**] (p.137). The flash will not fire if it is set to [**Mode 1**] or [**Mode 2**].

- If the camera is used with a flash unit or flash accessory dedicated to another camera brand, the camera may not operate properly and malfunction may result.
- Do not connect to the camera's PC terminal any flash unit requiring 250 V or more.
- Do not attach a high-voltage flash unit on the camera's hot shoe. It might not fire.

 A flash unit attached to the camera's hot shoe and a flash unit connected to the PC terminal can both be used at the same time.

6

Live View Shooting

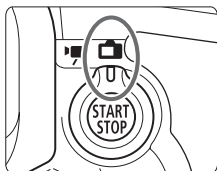

You can shoot while viewing the picture on the camera's LCD monitor. This is called "Live View shooting."

Live View shooting is enabled by setting the Live View shooting/Movie shooting switch to .

Live View shooting is effective for still subjects which do not move.

If you handhold the camera and shoot while viewing the LCD monitor, camera shake can cause blurred images. Using a tripod is recommended.



About Remote Live View Shooting

With EOS Utility (provided software) installed in your computer, you can connect the camera to the computer and shoot remotely while viewing the computer screen. For details, see the Software Instruction Manual in the CD-ROM.

Live View Shooting

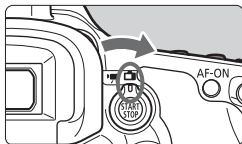

- 1 Set the Live View shooting/Movie shooting switch to .**



- 2 Display the Live View image.**

- Press the $\langle \text{START STOP} \rangle$ button.
- ▶ The Live View image will appear on the LCD monitor.
- The image's field of view is about 100%.



- 3 Focus the subject.**

- Before shooting, focus with AF or manual focus (p.138-145).
- When you press the shutter button halfway, the camera will focus with the current AF mode.

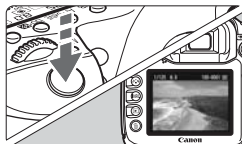

- 4 Take the picture.**

- Press the shutter button completely.
- ▶ The picture will be taken and the captured image is displayed on the LCD monitor.
- ▶ After the image review ends, the camera will return to Live View shooting automatically.
- Press the $\langle \text{START STOP} \rangle$ button to end the Live View shooting.

Battery Life with Live View Shooting [Approx. number of shots]



Temperature	Shooting Conditions	
	No Flash	50% Flash Use
At 23°C / 73°F	230	220
At 0°C / 32°F	220	210

- The figures above are based on a fully-charged Battery Pack LP-E6 and CIPA (Camera & Imaging Products Association) testing standards.
- Continuous Live View shooting is possible for about 1 hr. 30 min. at 23°C/73°F (with a fully-charged Battery Pack LP-E6).



- During Live View shooting, do not point the lens toward the sun. The sun's heat can damage the camera's internal components.
- **Cautions for using Live View shooting are on pages 146-147.**



- You can also focus by pressing the <AF-ON> button.
- When flash is used, there will be two shutter sounds, but only one shot will be taken.
- Even while the Live View image is displayed, you can playback images by pressing <▶>.
- If the camera is not operated for a prolonged period, the power will turn off automatically as set with [ **Auto power off**] (p.44). If [ **Auto power off**] is set to [Off], the Live View shooting will stop automatically after 30 min. (camera power remains on).
- With the AV cable (provided) or HDMI cable (sold separately), you can display the Live View image on a TV (p.176-177).

About the Information Display



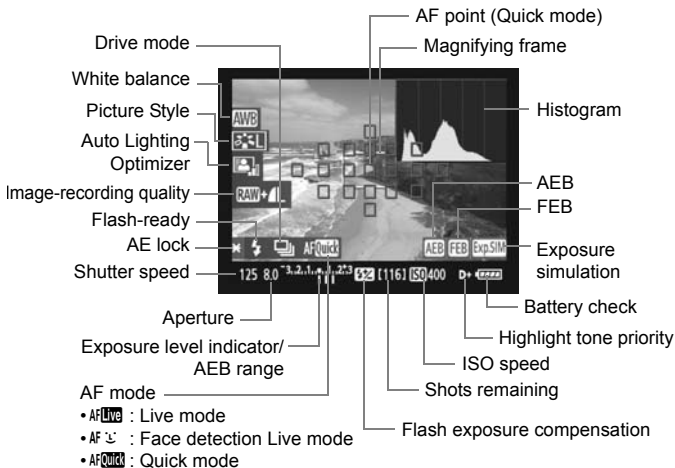



- Each time you press the <INFO.> button, the information display will change.



- The histogram can be displayed when [**Expo. simulation: Enable**] has been set (p.136).
- You can display the electronic level by pressing the <INFO.> button (p.228). Note that if the AF mode is set to [**Live mode**] or the camera is connected to a TV set with an HDMI cable, the electronic level cannot be displayed.
- When <Exp.SIM> is displayed in white, it indicates that the Live View image brightness is close to what the captured image will look like.
- If <Exp.SIM> is blinking, it indicates that the Live View image is not being displayed at the suitable brightness due to low or bright light conditions. However, the actual movie recorded will reflect the exposure setting.
- If flash is used or bulb is set, the <Exp.SIM> icon and histogram will be grayed out (for your reference). The histogram might not be properly displayed in low- or bright-light conditions.

Shooting Function Settings

ISO / / AF / DRIVE / WB / Settings

If you press the <ISO•>, <AF•DRIVE>, <•WB>, or <> button during Live View shooting, the setting screen will appear on the LCD monitor and you can turn the <> or <> dial to set the respective function. The <> metering mode cannot be set.

Quick Control

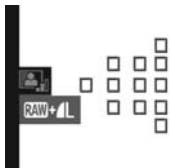

During Live View shooting, you can press the <> button to set the Auto Lighting Optimizer and image-recording quality. And with **AFQuick**, you can select the AF point and set the AF area selection mode.



1 Press the <> button.

- ▶ The settable functions will be highlighted in blue.
- When <**AFQuick**> is selected, the AF points will also be displayed.

2 Select a function and set it.

- Use <> to select a function.
- ▶ The setting of the selected function is displayed at the bottom.
- Turn the <> or <> dial to change the setting.
- When the selection of the AF point is enabled, the AF area selection mode for <**AFQuick**> can be selected with the <M-Fn> button.



- The metering mode will be fixed to evaluative metering for Live View shooting.
- To check the depth of field, press the depth-of-field preview button.
- During continuous shooting, the exposure set for the first shot will also be applied to subsequent shots.
- You can also use a remote controller (sold separately, p.110) for Live View shooting.

Menu Function Settings

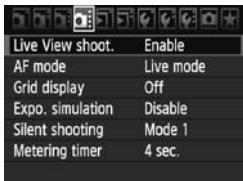

Live View shoot.	Enable
AF mode	Live mode
Grid display	Off
Expo. simulation	Disable
Silent shooting	Mode 1
Metering timer	4 sec.

Function settings particular to Live View shooting are explained here. The menu options under the [] tab are explained below.

Live View shoot.

Set Live View shooting to [Enable] or [Disable]. Even if [Disable] is set, you can still shoot movies (p.149).

AF mode

You can select [Live mode] (p.138), [ Live mode] (p.139), or [Quick mode] (p.143).

Grid display

With [Grid 1 ] or [Grid 2 ], you can display grid lines.

Expo. simulation [☆]

Exposure simulation displays and simulates how the brightness of the actual image will look. The [Enable] and [Disable] settings are explained below:

- **Enable**

The image brightness displayed will be close to the actual brightness of the resulting image. If you set exposure compensation, the image brightness will change accordingly.

- **Disable**

The image is displayed at the standard brightness to make the Live View image easy to see.

Silent shooting ☆

- **Mode 1**

The shooting operation noise is quieter than the normal shooting. Continuous shooting is also possible. High-speed continuous shooting will be approx. 7.0 fps.

- **Mode 2**

When you press the shutter button completely, only one shot will be taken. While you keep holding down the shutter button, the camera operation will be suspended. Then when you return to the shutter button's halfway position, the camera operation will resume. The shooting noise is thereby minimized. Even if continuous shooting is set, only a single shot can be taken in this mode.

- **Disable**

If you use a TS-E lens to make **vertical shift movements** or use an Extension Tube, be sure to set this to [**Disable**]. Setting it to [**Mode 1**] or [**Mode 2**] will result in incorrect or irregular exposures. When you press the shutter button completely, the shutter will sound like it took two shots. However, only one shot will be taken.



- If you use flash, the [**Disable**] operation will take effect even if you had set it to [**Mode 1**] or [**Mode 2**].
- When using a non-Canon flash unit, set it to [**Disable**]. (If [**Mode 1**] or [**Mode 2**] is set, the flash will not fire.)

Metering timer ☆

You can change the display time of the exposure setting.



If you select [**Dust Delete Data**], [**Sensor cleaning**], [**Clear all camera settings**], or [**Firmware Ver.**], the Live View shooting will be terminated.

Using AF to Focus

Selecting the AF Mode

The AF modes available are [Live mode], [Live mode] (face detection, p.139), and [Quick mode] (p.143).

If you want to achieve precise focus, set the lens focus mode switch to <MF>, magnify the image, and focus manually (p.145).

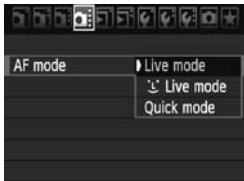

Select the AF mode.

- Under the [] tab, select [AF mode].
- While the Live View image is displayed, you can press the <AF·DRIVE> button to select the AF mode on the setting screen displayed.

Live Mode: AF Live

The image sensor is used to focus. Although AF is possible with the Live View image displayed, **the AF operation will take longer than with the Quick mode**. Also, achieving focus may be more difficult than with the Quick mode.



AF point

1 Display the Live View image.

- Press the < > button.
- ▶ The Live View image will appear on the LCD monitor.
- ▶ The AF point < > will appear.

2 Move the AF point.

- You can use < > to move the AF point to where you want to focus (it cannot go to the edges of the picture).
- If you press < > straight down, the AF point will return to the image center.



3 Focus the subject.

- Aim the AF points over the subjects and press the shutter button halfway.
- ▶ When focus is achieved, the AF point will turn green and the beeper will sound.
- ▶ If focus is not achieved, the AF point will turn red.



4 Take the picture.

- Check the focus and exposure, then press the shutter button completely to take the picture (p.132).

☺ (Face detection) Live Mode: AF ☺

With the same AF method as the Live mode, human faces are detected and focused. Have the target person face the camera.



1 Display the Live View image.

- Press the $\langle \overset{\text{START}}{\text{STOP}} \rangle$ button.
- ▶ The Live View image will appear on the LCD monitor.
- When a face is detected, the $\langle [] \rangle$ frame will appear over the face to be focused.
- If multiple faces are detected, $\langle [] \rangle$ will be displayed. Use $\langle \odot \rangle$ to move the $\langle [] \rangle$ frame over the target face.

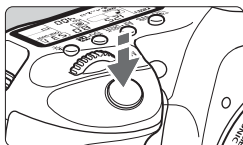

2 Focus the subject.

- Press the shutter button halfway and the camera will focus the face covered by the <[]> frame.
- ▶ When focus is achieved, the AF point will turn green and the beeper will sound.
- ▶ If focus is not achieved, the AF point will turn red.
- If a face cannot be detected, the AF point <[]> will be displayed and the center AF point will be used for focusing.



3 Take the picture.



- Check the focus and exposure, then press the shutter button completely to take the picture (p.132).

- If the focus is way off, face detection will not be possible. If the lens enables manual focusing even while the lens focus switch is set to <AF>, turn the focusing ring to attain rough focus. The face will then be detected and <[]> will be displayed.
- An object other than a human face might be detected as a face.
- Face detection will not work if the face is very small or large in the picture, too bright or too dark, titled horizontally or diagonally, or partially hidden.
- The <[]> focusing frame might cover only part of the face.

- When you press <[]> straight down, it will switch to the Live mode (p.138). You can tilt <[]> to move the AF point. If you press <[]> straight down again, it will switch back to <[]> (face detection) Live mode.
- Since AF is not possible with a face detected near the edge of the picture, the <[]> will be grayed out. Then if you press the shutter button halfway, the center AF point <[]> will be used to focus.

Live Mode and (Face Detection) Live Mode Notes

AF operation

- Focusing will take slightly longer.
- Even when focus has been achieved, pressing the shutter button halfway will focus again.
- The image brightness may change during and after the AF operation.
- If the light source changes while the Live View image is displayed, the screen might flicker and focusing can be difficult. If this happens, stop the Live View shooting and autofocus under the actual light source first.
- If you press the  button in the Live mode, the AF point area will be magnified. If it is difficult to focus in the magnified view, return to the normal view and autofocus. Note that the AF speed may differ between the normal and magnified views.
- If you autofocus in the Live mode's normal view and then magnify the image, the focus might be off.
- In the  Live mode, pressing the  button will not magnify the image.



- In the Live mode or  (face detection) Live mode, if you shoot a peripheral subject and the target subject is slightly out of focus, aim the center AF point over the subject to focus, then take the picture.
- The AF-assist beam will not be emitted.

Shooting conditions which can make focusing difficult:

- Low-contrast subjects such as the blue sky and solid-color, flat surfaces.
- Subjects in low light.
- Stripes and other patterns where there is contrast only in the horizontal direction.
- Under a light source whose brightness, color, or pattern keeps changing.
- Night scenes or points of light.
- Under fluorescent lighting or when the image flickers.
- Extremely small subjects.
- Subjects at the edge of the picture.
- Subjects strongly reflecting light.
- The AF point covers both a near and faraway subject (such as an animal in a cage).
- Subjects which keep moving within the AF point and cannot keep still due to camera shake or subject blur.
- A subject approaching or moving away from the camera.
- Autofocusing while the subject is way out of focus.
- Soft focus effect is applied with a soft focus lens.
- A special effects filter is used.

Quick Mode: AFQuick

The dedicated AF sensor is used to focus in the One-Shot AF mode (p.85), using the same AF method as with viewfinder shooting. Although you can focus the target area quickly, **the Live View image will be interrupted momentarily during the AF operation.**

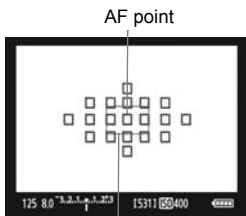

Magnifying frame

1 Display the Live View image.

- Press the $\langle \text{START/STOP} \rangle$ button.
- ▶ The Live View image will appear on the LCD monitor.
- The small boxes on the screen are the AF points, and the larger box is the magnifying frame.

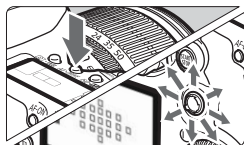
**2 Select the AF point.**

- When you press the $\langle \text{Q} \rangle$ button, the Quick Control screen will appear.
- ▶ The settable functions will be highlighted in blue.
- Use $\langle \text{AF-ON} \rangle$ to make the AF point selectable.
- Press the $\langle \text{M-Fn} \rangle$ button to change the AF area selection mode.
- Turn the $\langle \text{AF-AREA} \rangle$ and $\langle \text{AF-ON} \rangle$ dial to select the AF point.

Focusing Manually ☆

You can magnify the image and focus precisely manually.

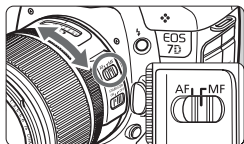

1 Set the lens focus mode switch to <MF>.

- Turn the lens focusing ring to focus roughly.



Magnifying frame

2 Move the magnifying frame.

- Use <⬆> to move the magnifying frame to the position where you want to focus.
- If you press <⬆> straight down, the AF point will return to the image center.

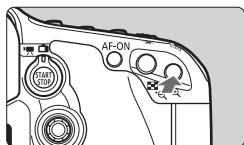

3 Magnify the image.

- Press the <⊕> button.
- ▶ The image within the magnifying frame will be magnified.
- Each time you press the <⊖> button, the display format will change as follows:

→ 5x → 10x → Normal view →



AE lock
Magnified area position
Magnification

4 Focus manually.

- While looking at the magnified image, turn the lens focusing ring to focus.
- After achieving focus, press the <⊖> button to return to the normal view.



5 Take the picture.

- Check the focus and exposure, then press the shutter button to take the picture (p.132).

Notes About the Live View Image

- Under low or bright light conditions, the Live View image might not reflect the brightness of the captured image.
- If the light source within the image changes, the screen might flicker. If this happens, stop and resume the Live View shooting under the actual light source to be used.
- If you point the camera in a different direction, it might throw off the Live View image's correct brightness momentarily. Wait until the brightness level stabilizes before shooting.
- If there is a very bright light source in the picture, such as the sun, the bright area might appear black on the LCD monitor. However, the actual captured image will correctly show the bright area.
- In low light, if you set the [ LCD brightness] to a bright setting, chrominance noise may appear in the Live View image. However, the chrominance noise will not be recorded in the captured image.
- When you magnify the image, the image sharpness may look more pronounced than it really is.

About the icon

- If Live View shooting is used under direct sunlight or in other hot environments, the  icon (warning for the camera's high internal temperature) may appear on the screen. If Live View shooting continues with a high internal temperature, it may degrade image quality. You should therefore stop Live View shooting if the warning icon appears.
- If Live View shooting continues while the  warning icon is displayed and the camera's internal temperature increases, the Live View shooting will stop automatically. Live View shooting will be disabled until the camera's internal temperature decreases.



Notes About the Shooting Results

- When you shoot continuously with the Live View function for a long period, the camera's internal temperature may increase and it can degrade image quality. Terminate Live View shooting when not shooting images.
- Before taking a long exposure, stop Live View shooting temporarily and wait several minutes before shooting. This is to prevent image degradation.
- Live View shooting in high temperatures and at high ISO speeds may cause noise or irregular colors.
- When you shoot at high ISO speeds, noise (horizontal banding, dots of light, etc.) may appear.
- If you take the picture during magnified view, the exposure might not come out as desired. Return to the normal view before taking the picture. During the magnified view, the shutter speed and aperture will be displayed in red. Even if you take the picture during magnified view, the image will be captured in the normal view.

Custom Function Notes

- During Live View shooting, certain Custom Function settings will be disabled (p.205).
- If the [] **Auto Lighting Optimizer** (p.75) menu is set to anything other than [**Disable**], the image may look bright even if a decreased exposure compensation or flash exposure compensation has been set.

Notes About Lenses and Flash

- The focus preset feature on super telephoto lenses cannot be used.
- FE lock is not possible when the built-in flash or an external Speedlite is used. Modeling flash and test flash will not fire (except for wireless flash shooting) if an external Speedlite is used.



7

Shooting Movies

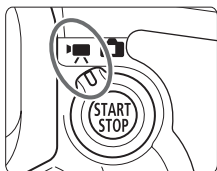

Movie shooting is enabled by setting the Live View shooting/Movie shooting switch to <  >. The movie file format will be MOV.

When shooting movies, use a large-capacity card having a read/write speed of at least 8 MB/sec.

If you use a slow card when shooting movies, the movie might not be recorded properly. Also, if you playback movies on a card having a slow read/write speed, movie might not playback properly. To check the card's read/write speed, refer to the card manufacturer's Web site.

About Full HD 1080

Full HD 1080 indicates compatibility with High-Definition with 1080 vertical pixels (scanning lines).



Shooting Movies

Connecting the camera to a TV set is recommended to playback movies (p.176-177).

Shooting with Autoexposure

When the shooting mode is set to a shooting mode other than <M>, autoexposure control will take effect to fit the scene current brightness. Autoexposure control will be the same for all shooting modes.

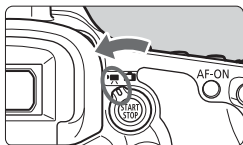

1 Set the Live View shooting/Movie shooting switch to <Movie>.

- ▶ The reflex mirror will make a sound, then the image will appear on the LCD monitor.

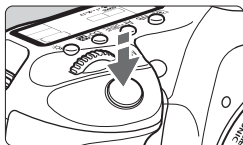

2 Focus the subject.

- Before shooting a movie, autofocus or manual focus (p.138-145).
- When you press the shutter button halfway, the camera will focus with the current AF mode.

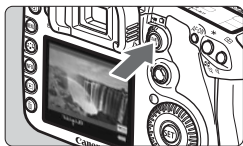

3 Shoot the movie.

- Press the <START STOP> button to start shooting the movie. To stop shooting the movie, press the <START STOP> button again.
- ▶ While the movie is being shot, the "●" mark will be displayed on the upper right of the screen.

- During movie shooting, do not point the lens toward the sun. The sun's heat can damage the camera's internal components.
- **Cautions for movie shooting are on pages 158-159.**
- **If necessary, also read the Live View shooting cautions on pages 146 and 147.**



- You can also focus by pressing the <AF-ON> button.
- One continuous movie will be recorded as one file.
- During movie shooting, the top, bottom, left, and right parts of the screen will have a semi-transparent mask. The area enclosed by the semi-transparent mask will be the movie image that is recorded. The semi-transparent mask size will change depending on the [Movie rec. size] setting (p.156).
- AE lock is possible by pressing the <★> button (p.106).
- In all shooting modes except <M>, the ISO speed (100-6400 or expanded to 12800), shutter speed, and aperture will be set automatically.
- Pressing the shutter button halfway displays the shutter speed and aperture (p.152) on the screen's bottom left. This is the exposure setting for taking a still photo (except for <M>).
- The sound is recorded in monaural by the camera's built-in microphone (p.16).
- Stereo sound recording is possible by connecting an external microphone equipped with a stereo mini plug (3.5mm dia.) to the camera's external microphone IN terminal (p.16).
- The sound recording level will be adjusted automatically.
- You can use Remote Controller RC-1/RC-5 (sold separately, p.110) to start and stop the movie shooting if the drive mode is <ⓘⓈ> or <ⓘⓈ₂>. With RC-1, set the timing switch to <2> (2-sec. delay), then press the transmit button. If the switch is set to <●> (immediate shooting), still photo shooting will take effect.
- With a fully-charged Battery Pack LP-E6, the total shooting time will be as follows: At 23°C/73°F: Approx. 1 hr. 20 min., At 0°C/32°F: Approx. 1 hr. 10 min.

About the Information Display

- Each time you press the <INFO.> button, the information display will change.

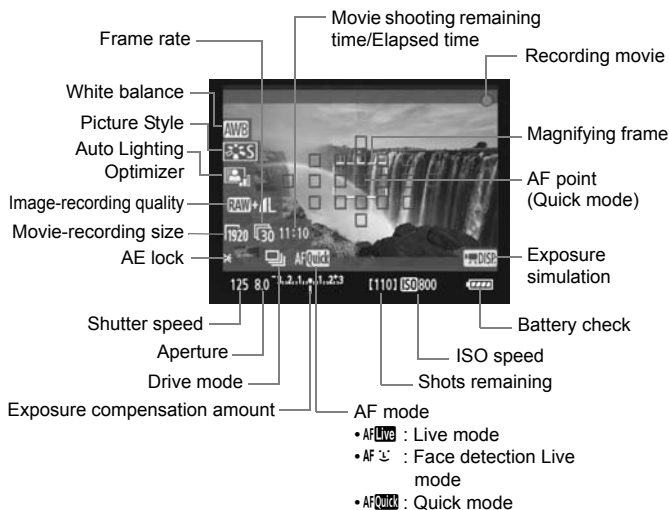





- You can display the electronic level by pressing the <INFO.> button (p.228). When you start shooting a movie, the electronic level will turn off. To display the electronic level again, stop the movie shooting and press the <INFO.> button. Note that if the AF mode is set to [**Live mode**] or the camera is connected to a TV set with an HDMI cable (p.177), the electronic level cannot be displayed.
- If there is no card in the camera, the movie shooting remaining time will be displayed in red.
- When movie shooting starts, the movie shooting remaining time will change to the elapsed time.
- When <DISP> is displayed in white, it indicates that the Live View image brightness is close to what the actual movie will look like.

Using Manual Exposure





When the shooting mode is <M> (p.102), you can manually set the shutter speeds, aperture, and ISO speeds shown below and shoot a movie. Using manual exposure to shoot movies is for advanced users.

Shutter speed : Turn the < > dial. The settable shutter speeds depend on the frame rate < >.

•  /  : 1/4000 sec. - 1/60 sec.

•  /  /  : 1/4000 sec. - 1/30 sec.



Aperture : Set the Quick Control Dial switch to <f/>, and turn the < > dial.

ISO speed : Press the <ISO- > button, then turn the < > dial.

• Manual setting range : 100 - 6400

• Auto ISO range : 100 - 6400

-  ● AE lock and exposure compensation cannot be set.
- If <AWB> is set and the ISO speed or aperture changes during movie shooting, the white balance may also change.
- If you shoot a movie under fluorescent lighting, the movie image might flicker.

-  ● With the ISO speed set to Auto, you can shoot a movie as if it were in aperture-priority AE mode (fixed aperture, standard exposure).
- If [ C.Fn II -3: Highlight tone priority] is set to [1: Enable], the settable ISO speed range will be ISO 200 - 6400.
- When shooting a movie of a moving subject, a shutter speed of 1/30 sec. to 1/125 sec. is recommended. The faster the shutter speed, the less smooth the subject's movement will look.
- Changing the aperture during movie shooting is not recommended since variations in the exposure, due to the drive of the lens aperture, will be recorded.
- If you playback the movie with "Shooting information display" (p.163), the shooting mode, shutter speed, and aperture will not be displayed. The image information (Exif) will record the settings used at the start of the movie.

Shooting Still Photos

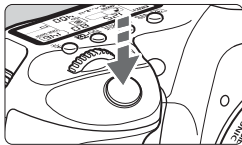

You can take a still photo at anytime by pressing the shutter button completely, even during movie shooting.

Taking still photos during movie shooting







- The still photo will record the entire screen including the semi-transparent mask.
- If you take a still photo during movie shooting, the movie will have a still moment lasting about 1 sec.
- The captured still photo will be recorded to the card, and the movie shooting will resume automatically when the Live View image is displayed.
- The card will record the movie and still photo as separate files.
- Functions particular to still shooting are shown below. Other functions will be the same as for movie shooting.

Function	Setting
Image-recording quality	As set in the [Quality] menu.
Exposure setting	Shutter speed and aperture set automatically (Manually if shooting mode is <M>). Displayed when the shutter button is pressed halfway.
AEB	Canceled
Drive mode	Modes other than self-timer available.
Flash	Flash off

- For shooting still photos during movie shooting, using a UDMA (Ultra DMA) card having a writing speed faster than 8 MB/sec. is recommended.
- If the shooting mode is <M>, the shutter speed, aperture, and ISO speed set for movie shooting will be used as is.

Shooting Function Settings

AF / DRIVE / WB / / ISO Settings

If you press the <AF•DRIVE>, <•WB>, or <> button while the image is displayed on the LCD monitor, the setting screen will appear on the LCD monitor and you can turn the <> or <> dial to set the respective function. Note that the <> metering mode cannot be set. If the shooting mode is <M>, you can press the <ISO•> button and turn the <> dial to set the ISO speed.

Quick Control

With the image displayed on the LCD monitor, you can press the <Q> button to set the Auto Lighting Optimizer, image-recording quality for still photos, and movie recording size. And with **AFQuick**, you can select the AF point and set the AF area selection mode.

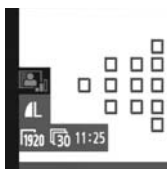



1

Press the <Q> button.

- ▶ The settable functions will be highlighted in blue.
- When <AFQuick> is selected, the AF points will also be displayed.

2

Select a function and set it.

- Use <> to select a function.
- ▶ The setting of the selected function is displayed at the screen bottom.
- Turn the <> or <> dial to change the setting.
- When the selection of the AF point is enabled, the AF area selection mode for <AFQuick> can be selected with the <M-Fn> button.





- Exposure compensation can be set (except in <M> mode).
- The Picture Style, white balance, image-recording quality, and exposure compensation (except in <M> mode) set for movie shooting will also be applied to still photos.

Menu Function Settings



AF mode	Live mode
Grid display	Off
Movie rec. size	1920x1080 
Sound recording	On
Silent shooting	Mode 1
Metering timer	4 sec.

Function settings particular to movie shooting are explained here. When the Live View shooting/Movie shooting switch is set to < >, the menu will show the [] tab. The menu options are as follows.

AF mode

The AF mode will be the same as described on pages 138-144. You can select [**Live mode**], [ **Live mode**], or [**Quick mode**]. Note that continuous focusing of a moving subject is not possible.

Grid display



With [**Grid 1** ] or [**Grid 2** ], you can display grid lines.





Movie-recording size

[**1920x1080**] : Full HD (Full High-Definition) recording quality.







[**1280x720**] : HD (High-Definition) recording quality.

[**640x480**] : Standard recording quality. The screen format will be 4:3.

The [] (frame rate) indicates how many frames are recorded per second. This will change depending on the [ **Video system**] menu setting (NTSC for North America, Japan, Korea, Mexico, etc., or PAL for Europe, Russia, China, Australia, etc.). Note that [] is used for motion pictures.

* The actual frame rate will be: : 29.97, : 25.00, : 23.976, : 59.94, : 50.00

Total Movie Recording Time and File Size Per Minute

Movie-recording Size	Total Recording Time		File Size	
	4GB Card	16GB Card		
[1920x1080]		12 min.	49 min.	330 MB/min.
				
				
[1280x720]		12 min.	49 min.	330 MB/min.
				
[640x480]		24 min.	1 hr. 39 min.	165 MB/min.
				



- After you start shooting a movie, the movie shooting will stop automatically if the file size reaches 4 GB or if the movie time reaches 29 min. 59 sec. To shoot a movie again, press the $\langle \overset{\text{START}}{\text{STOP}} \rangle$ button. (A new movie file starts being recorded.)
- The semi-transparent mask on the top and bottom and on the left and right will not be recorded.
- With ZoomBrowser EX/ImageBrowser (provided software), you can extract a still image from the movie. The still image quality will be as follows: Approx. 2 megapixels at [1920x1080], approx. 1 megapixel at [1280x720], and approx. 300,000 pixels at [640x480].

Sound recording

When the sound recording is set to [On], monaural sound will be recorded with the built-in microphone. Stereo sound recording is possible by connecting an external microphone equipped with a stereo mini plug (3.5mm dia.) to the camera's external microphone IN terminal (p.16). The sound recording level will be adjusted automatically.

Silent shooting [☆]

This function applies when shooting still photos (p.137).

Metering timer [☆]

You can change how long the AE lock is to be maintained with the $\langle \star \rangle$ button.

Notes on Movie Shooting



Recording and Image Quality

- If the attached lens has an Image Stabilizer, the Image Stabilizer will operate at all times even if you do not press the shutter button halfway. The Image Stabilizer may cause the total movie shooting time or the number of possible shots to decrease. If you use a tripod or if the Image Stabilizer is not necessary, you should set the IS switch to <OFF>.
 - The camera's built-in microphone will also pick up camera operation noise. If you use a commercially-available external microphone, you can prevent (or reduce) these noises from being recorded.
 - Do not connect the external microphone IN terminal to anything other than an external microphone.
 - Autofocusing during movie shooting is not recommended since it might momentarily throw the focus way off or change the exposure. Even if the AF mode has been set to [Quick mode], it will switch to the Live mode during movie shooting.
 - If movie shooting is not possible due to the insufficient remaining capacity of the card, the movie shooting remaining time (p.152) will be displayed in red.
 - If you use a card having a slow writing speed, a five-level indicator might appear on the right of the screen during movie shooting. It indicates how much data has not yet been written to the card (remaining capacity of the internal buffer memory). The slower the card, the faster the indicator will climb upward. If the indicator becomes full, movie shooting will stop automatically.

Indicator
- If the card has a fast writing speed, the indicator will either not appear or the level (if displayed) will hardly go upward. First, shoot a few test movies to see if the card can write fast enough. If you take still photos during the movie shooting, the movie shooting might stop. If the still image recording quality has been set low, the movie shooting might continue instead.
- When movie shooting is set, certain Custom Function settings will be disabled (p.205).



Notes on Movie Shooting

Camera's internal temperature increase and image degradation

- If you continue to shoot movies for a prolonged period, the camera's internal temperature will increase. This can degrade the image quality. While not shooting, turn off the power.
- If you shoot under direct sunlight or high-temperature conditions, the  icon (high internal temperature warning) may appear on the screen. If you keep shooting a movie with the warning icon displayed, the image quality might degrade. You should turn off the power and allow the camera to rest for a while.
- If the  icon is displayed and you keep shooting movies until the camera's internal temperature increases further, the movie shooting will stop automatically. If this happens, you will not be able to shoot again until the camera's internal temperature decreases. Turn off the power and let the camera rest for a while.

Playback and TV connection

- If the brightness changes during movie shooting, that part might freeze momentarily.
- If the camera is connected to a TV set with an HDMI cable (p.177), pressing the **<INFO.>** button during movie shooting will not display the INFO screen.
- If you connect the camera to a TV set (p.176-177) and shoot a movie, the TV will not output any sound during the shooting. However, the sound will be properly recorded.



8

Image Playback

This chapter explains how to playback and erase photos and movies, how to display images on a TV screen, and other playback-related functions.

About images taken with another camera:

The camera might not be able to properly display images captured with a different camera or edited with a computer or whose file name was changed.

▶ Image Playback

Single Image Display



1 Playback the image.

- Press the <▶> button.
- ▶ The last captured image or last image viewed will appear.



2 Select the image.

- To playback images starting with the last image, turn the <◀> dial counterclockwise. To playback images starting with the first captured image, turn the dial clockwise.
- Press the <INFO.> button to change the display format.



Single image display



Single image display +
Image-recording quality

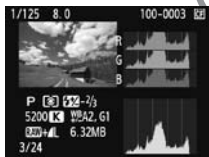

Histogram display



Shooting information display

3 Exit the image playback.

- Press the <▶> button to exit the image playback and return the camera to shooting ready.

INFO. Shooting Information Display

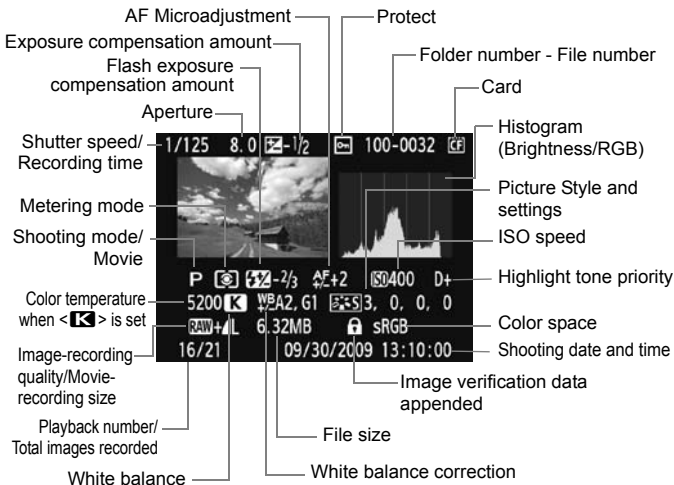

* When you shoot in the RAW+JPEG mode, the JPEG image file size will be displayed.

* In the case of movies, the movie icon <MOV>, file type [MOV], and recording size ([1920], [1280], [640]) will be displayed. The shutter speed and certain other shooting information will not be displayed.

● About the Highlight Alert

When the [Highlight alert] menu option is set to [Enable], overexposed highlight areas will blink. To obtain more image detail in the overexposed areas, set the exposure compensation to a negative amount and shoot again.

● About the AF Point Display

When the [AF point disp.] menu option is set to [Enable], the AF point which achieved focus will be displayed in red. If automatic AF point selection was used, multiple AF points might be displayed in red.

● About the Histogram

The brightness histogram display shows the exposure level distribution and overall brightness. The RGB histogram display is for checking the color saturation and gradation. The display can be switched with the [**☐** Histogram] menu option.

[Brightness] Display

This histogram is a graph showing the distribution of the image's brightness level. The horizontal axis indicates the brightness level (darker on the left and brighter on the right), while the vertical axis indicates how many pixels exist for each brightness level. The more pixels there are toward the left, the darker the image. And the more pixels there are toward the right, the brighter the image. If there are too many pixels on the left, the shadow detail will be lost. And if there are too many pixels on the right, the highlight detail will be lost. The gradation in-between will be reproduced. By checking the image and its brightness histogram, you can see the exposure level inclination and the overall gradation

Sample Histograms



Dark image



Normal brightness



Bright image

[RGB] Display

This histogram is a graph showing the distribution of each primary color's brightness level in the image (RGB or red, green, and blue). The horizontal axis indicates the color's brightness level (darker on the left and brighter on the right), while the vertical axis indicates how many pixels exist for each color brightness level. The more pixels there are toward the left, the darker and less prominent the color. And the more pixels there are toward the right, the brighter and denser the color. If there are too many pixels on the left, the respective color information will be lacking. And if there are too many pixels on the right, the color will be too saturated with no detail. By checking the image's RGB histogram, you can see the color's saturation and gradation condition and white balance inclination.

▶ Searching for Images Quickly

▣ Display Multiple Images on One Screen (Index display)

Search for images quickly with the index display showing four or nine images on one screen.



1 Turn on the index display.

- During image playback, press the <▣·Q> button.
- ▶ The 4-image index display will appear. The currently-selected image will be highlighted in a blue frame.
- Press the <▣·Q> button again to switch to the 9-image index display. Pressing the <Ⓢ> button will toggle the display from 9 images, 4 images, and one image displayed.



2 Select the image.

- Turn the <⦿> dial to move the blue frame to select the image.
- Press <Ⓢ> and the selected image will be displayed as a single image.

Jump through Images (Jump display)



With the single image display, you can turn the < > dial to jump through the images.





Jump method

Image location

1 Select the jump method.

- In the [ Image jump w/] menu, select the desired jump method from [1 image/10 images/100 images/Date/Folder/Movies/Stills], then press <SET>.

2 Browse by jumping.

- Press the < > button to playback the image.
- Turn the < > dial.
- ▶ The jump display will proceed according to the selected jump method.
- ▶ On the bottom right, the jump method and current image location are indicated.

- To search images according to the shooting date, select [**Date**]. Turn the < > dial to display the shooting date.
- To search images according to folder, select [**Folder**].
- If the card has both [**Movies**] and [**Stills**], select either one to display only movies or stills.

🔍/🔍 Magnified View

You can magnify the image by 1.5x to 10x on the LCD monitor.

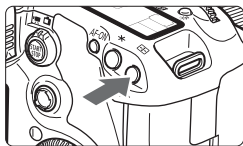

Magnified area position

1 Magnify the image.

- During image playback, press the <🔍+> button.
- ▶ The image will be magnified.
- To increase the magnification, hold down the <🔍+> button. The image will continue to be magnified until it reaches the maximum magnification.
- Press the <🔍-> button to reduce the magnification. If you hold down the button, the magnification will continue to reduce to the single image display.



2 Scroll around the image.

- Use <🌀> to scroll around the magnified image.
- To exit the magnified display, press the <▶> button and the single-image display will return.





- You can turn the <🌀> dial to view another image while the magnification is maintained.
- Magnified view is not possible during the image review immediately after the image is taken.
- A movie cannot be magnified.

Rotating the Image

You can rotate the displayed image to the desired orientation.



1 Select [Rotate].

- Under the [] tab, select [Rotate], then press </>.









2 Select the image.

- Turn the </> dial to select the image to be rotated.
- You can also select an image on the index display.



3 Rotate the image.

- Each time you press </>, the image will rotate clockwise as follows: 90° → 270° → 0°
- To rotate another image, repeat steps 2 and 3.
- To exit and return to the menu, press the <MENU> button.

- If you have set [ Auto rotate] to [On  ] (p.182) before taking vertical shots, you need not rotate the image as described above.
- If the rotated image is not displayed in the rotated orientation during image playback, set the [ Auto rotate] menu option to [On  ].
- A movie cannot be rotated.

Enjoying Movies

Basically, there are the following three ways to playback the movies you shot.

Playback on a TV set (p.176, 177)

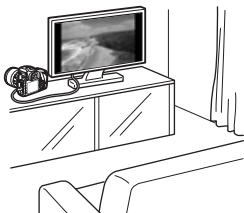

Use the provided AV cable or an HDMI Cable HTC-100 (sold separately) to connect the camera to a TV set. Then you can playback the captured movies and photos on the TV.

If you have a High-Definition TV set and connect your camera to it with an HDMI cable, you can watch Full HD (Full High-Definition 1920x1080) and HD (High-Definition 1280x720) movies with higher image quality.

- Movies on a card can be played only by devices compatible with MOV files.
- Since hard disk recorders do not have an HDMI IN terminal, the camera cannot be connected with an HDMI cable.
- Even if the camera is connected to a hard disk recorder with a USB cable, movies and photos cannot be played nor saved.

Playback on the Camera's LCD Monitor (p.171-175)

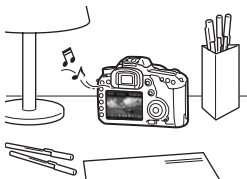

You can playback the movie on the camera's LCD monitor and even edit out the first and last scenes. You can also playback the photos and movies recorded in the card as an automatic slide show.

- A movie edited with a personal computer cannot be rewritten to the card and played back with the camera.

Playback and Editing with a Personal Computer

(See the PDF file instruction manual for ZoomBrowser EX/ImageBrowser)

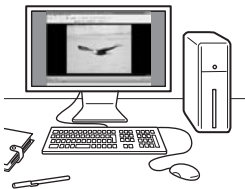

The movie files recorded in the card can be transferred to a personal computer and played or edited with ZoomBrowser EX/ImageBrowser (provided software). You can also extract a single frame from a movie and save it as a still photo.

- To have the movie playback smoothly on a personal computer, the personal computer must be a high-performance model. Regarding the hardware requirements for ZoomBrowser EX/ImageBrowser, see the PDF file instruction manual.
- If you want to use commercially-available software to playback or edit the movies, be sure it is compatible with MOV files. For details on commercially-available software, inquire the software maker.

▶ Playing Movies



1 Playback the image.

- Press the <▶> button to display the image.



2 Select a movie.

- Turn the <☉> dial to select the image.
- During the single-image display, the <▶ SET> icon displayed on the upper left indicates that it is a movie.
- During the index display, the perforation on the left edge of the image indicates that it is a movie. **Movies cannot be played on the index display, so press <SET> to switch to the single-image display.**



3 On the single-image display, press <SET>.

- ▶ The movie playback panel will appear on the bottom.









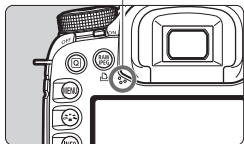



4 Playback the movie.

- Turn the <☉> dial to select [▶] (play), then press <SET>.
- ▶ The movie will start playing.
- You can pause the movie playback by pressing <SET>.
- During movie playback, you can adjust the sound volume by turning the <☀> dial.
- For more details on the playback procedure, see the next page.

Speaker

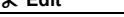

Function	Playback Description
 Exit	Returns to the single-image display.
 Play	Pressing <SET> toggles between play and pause.
 Slow motion	Adjust the slow motion speed by turning the <DIAL> dial. The slow-motion speed is indicated on the upper right.
 First frame	Displays the movie's first frame.
 Previous frame	Each time you press <SET>, a single previous frame is displayed. If you hold down <SET>, it will rewind the movie.
 Next frame	Each time you press <SET>, the movie will play frame-by-frame. If you hold down <SET>, it will fast forward the movie.
 Last frame	Displays the movie's last scene.
 Edit	Displays the editing screen (p.173).
	Playback position
mm' ss"	Playback time
 Volume	You can adjust the built-in speaker's (p.17) sound volume by turning the <DIAL> dial.

- With a fully-charged Battery Pack LP-E6, the continuous playback time at 23°C/73°F will be as follows: Approx. 3 hr.
- During the single-image display, press the <INFO.> button to switch the shooting information display (p.228).
- If you took a still photo when you shot the movie, the still photo will be displayed for about 1 sec. during the movie playback.
- If you connect the camera to a TV set (p.176-177) to playback a movie, adjust the sound volume with the TV set. (Turning the <DIAL> dial will not adjust the sound volume.)

✂ Editing the Movie's First and Last Scenes ■

You can edit out the first and last scenes of a movie in 1-sec. increments.



1 On the movie playback screen, select [✂].

- ▶ The editing screen will be displayed.



2 Specify the parts to be edited out.

- Select either [⏪] (Cut beginning) or [⏩] (Cut end), then press <SET>.
- Tilt <◂> to the left or right to fast forward or turn the <⌚> dial (Next frame) to specify the part to be edited out, then press <SET>.
- The portion highlighted in blue on the top of the screen is what will remain.



3 Check the editing.

- Select [▶] and press <SET> to playback the portion highlighted in blue.
- To change the editing, go back to step 2.
- To cancel the editing, select [↶] and press <SET>.



4 Save the movie.

- Select [⏪], then press <SET>.
- ▶ The save screen will appear.
- To save it as a new movie, select [New file]. Or to save it and overwrite the original movie file, select [Overwrite]. Then press <SET>.



- If the card does not have enough space to save the movie, only [Overwrite] can be selected.
- More movie editing functions are available with ZoomBrowser EX/ImageBrowser (provided software).

MENU Slide Show (Auto Playback)

You can playback the images in the card as an automatic slide show.



1 Select [Slide show].

- Under the [] tab, select [Slide show], then press <SET>.

Number of images to be played



2 Select the images to be played back.

- Turn the <DISP> dial to select the item, then press <SET>.

[All images/Movies/Stills]

- Turn the <DISP> dial to select one of the following: [All images/ Movies/ Stills]. Then press <SET>.



[Folder/Date]

- Turn the <DISP> dial to select either [Folder] or [Date].
- When <INFO> is displayed brightly, press the <INFO> button.
- Turn the <DISP> dial to select the folder or date, then press <SET>.

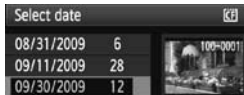

Item	Playback Description
All images	All the still photos and movies in the card will be played back.
Folder	Still photos and movies in the selected folder will be played back.
Date	Still photos and movies taken on the selected shooting date will be played back.
Movies	Only the movies in the card will be played back.
Stills	Only the still photos in the card will be played back.



3 Set the play time and repeat option.

- Turn the < > dial to select [**Set up**], then press < >.
- For still photos, set the [**Play time**] and [**Repeat**] options, then press the < **MENU** > button.

[Play time]

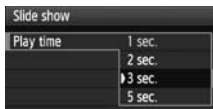

[Repeat]



4 Start the slide show.

- Turn the < > dial to select [**Start**], then press < >.
- ▶ After [**Loading image...**] is displayed for a few seconds, the slide show will start.

5 Quit the slide show.

- To quit the slide show and return to the setting screen, press the < **MENU** > button.



- To pause the slide show, press < >. During pause, [III] will be displayed on the upper left of the image. Press < > again to resume the slide show.
- During auto playback, you can press the < **INFO.** > button to change the still photo display format.
- During movie playback, you can adjust the sound volume by turning the < >.
- During pause, you can turn the < > or < > dial to view another image.
- During the slide show, auto power off will not work.
- The display time may vary depending on the image.
- To view the slide show on a TV set, see pages 176-177.

Viewing the Images on TV

You can also view the still photos and movies on a TV set. Before connecting or disconnecting the cable between the camera and television, turn off the camera and television.

* Adjust the movie's sound volume with the TV set.

* Depending on the TV set, part of the image displayed might be cut off.

Viewing on Non-HD (High-Definition) TV Sets

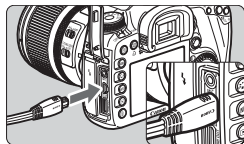

1 Connect the provided AV cable to the camera.

- Connect the AV cable to the camera's <A/V OUT/DIGITAL> terminal.
- With the plug's <Canon> logo facing the back of the camera, insert it into the <A/V OUT/DIGITAL> terminal.

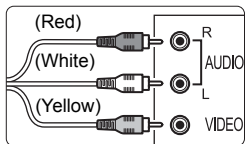

2 Connect the AV cable to the TV set.

- Connect the AV cable to the TV's video IN terminal and to the audio IN terminal.

3 Turn on the TV and switch the TV's video input to select the connected port.

4 Set the camera's power switch to <ON>.

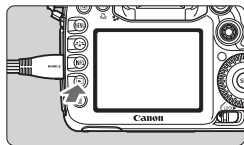

5 Press the <▶> button.

- ▶ The image will appear on the TV screen. (Nothing will be displayed on the camera's LCD monitor.)
- To playback movies, see page 171.

- If the video system format does not match the TV's, the images will not be displayed properly. Set the proper video system format with [**Video system**].
- Do not use any AV cable other than the one provided. Images might not be displayed if you use a different cable.

Viewing on HD (High-Definition) TV Sets

The HDMI Cable HTC-100 (sold separately) is required.

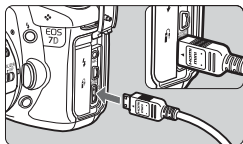

1 Connect the HDMI cable to the camera.

- Connect the HDMI cable to the camera's <HDMI OUT> terminal.
- With the plug's <▲HDMI MINI> logo facing the front of the camera, insert it into the <HDMI OUT> terminal.

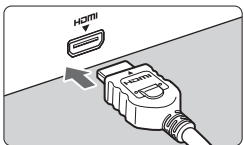

2 Connect the HDMI cable to the TV set.

- Connect the HDMI cable to the TV's HDMI IN port.

3 Turn on the TV and switch the TV's video input to select the connected port.

4 Set the camera's power switch to <ON>.

5 Press the <▶> button.

- ▶ The image will appear on the TV screen. (Nothing will be displayed on the camera's LCD monitor.)
- The images will be displayed at the TV's optimum resolution automatically.
- By pressing the <INFO.> button, you can change the display format.
- To playback movies, see page 171.

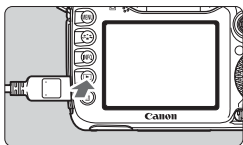

- Do not connect any other device's output to the camera's <HDMI OUT> terminal. Doing so may cause a malfunction.
- Some TVs might not be able to display the captured images. In such a case, use the provided AV cable to connect to the TV.
- The camera's <A/V OUT/DIGITAL> terminal and <HDMI OUT> terminal cannot be used at the same time.

Protecting Images



Protecting the image prevents it from being erased accidentally.



Image protect icon



- 1 Select [Protect images].**
 - Under the [] tab, select [**Protect images**], then press <SET>.
 - ▶ The protect setting screen will appear.

- 2 Select the image and protect it.**
 - Turn the <> dial to select the image to be protected, then press <SET>.
 - ▶ When an image is protected, the <> icon will appear on the screen.
 - To cancel the image protection, press <SET> again. The <> icon will disappear.
 - To protect another image, repeat step 2.
 - To exit the image protection, press the <MENU> button. The menu will reappear.

 **If you format the card (p.43), the protected images will also be erased.**

- Once an image is protected, it cannot be erased by the camera's erase function. To erase a protected image, you must first cancel the protection.
- If you erase all the images (p.180), only the protected images will remain. This is convenient when you want to erase unnecessary images all at once.

Erasing Images

You can either select and erase images one by one or erase them in one batch. Protected images (p.178) will not be erased.

- 1 **Once an image is erased, it cannot be recovered. Make sure you no longer need the image before erasing it. To prevent important images from being erased accidentally, protect it. Erasing a RAW+JPEG image will erase both the RAW and JPEG images.**

Erasing a Single Image





- 1 **Playback the image to be erased.**

- 2 **Press the  button.**

- ▶ The erase menu will appear at the bottom of the screen.



- 3 **Erase the image.**



- Turn the  dial to select [Erase], then press . The image displayed will be erased.

MENU Checkmarking Images to be Erased in a Batch

By checkmarking the images to be erased, you can erase multiple images at one time.



- 1 **Select [Erase images].**

- Under the  tab, select [Erase images], then press .



2 Select [Select and erase images].

- Turn the < > dial to select [**Select and erase images**], then press < >.
- ▶ The image will be displayed.
- To display the three-image view, press the < > button. To return to the single-image display, press the < > button.



3 Select the images to be erased.

- Turn the < > dial to select the image to be erased, then press < >.
- ▶ The < > icon will be displayed on the upper left.
- To erase other images, repeat step 3.



4 Erase the image.

- Press the < > button.
- Turn the < > dial to select [**OK**], then press < >.
- ▶ The selected images will be erased.

MENU Erasing All Images in a Folder or Card

You can erase all the images in a folder or card at one time. When the [**Erase images**] menu is set to [**All images in folder**] or [**All images on card**], all the images in the folder or card will be erased.

To also erase protected images, format the card (p.43).

Changing Image Playback Settings

MENU Adjusting the LCD Monitor Brightness

The LCD monitor's brightness is adjusted automatically for optimum viewing. You can set the automatic adjustment's brightness level (brighter or darker) or adjust the brightness manually.



1 Select [LCD brightness].

- Under the [] tab, select [**LCD brightness**], then press <SET>.

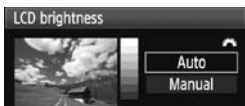

2 Select [Auto] or [Manual].

- Turn the < > dial to make the selection.

3 Adjust the brightness.

- While referring to the gray chart, turn the < > dial, then press <SET>.
- You can adjust [**Auto**] to one of three levels, and [**Manual**] to one of seven levels.



Automatic adjustment



Manual adjustment



- While [**Auto**] is set, be careful not to obstruct the round, external light sensor on the right of the LCD monitor with your finger, etc.
- To check the image's exposure, you should look at the histogram (p.164).

MENU Auto Rotation of Vertical Images



Vertical images are rotated automatically so they are displayed vertically on the camera's LCD monitor and computer instead of horizontally. The setting of this feature can be changed.

1 Select [Auto rotate].

- Under the [F⁺] tab, select [Auto rotate], then press <SET>.

2 Set the auto rotate.

- Turn the <DISP> dial to select the setting, then press <SET>.



- **On**  

The vertical image is automatically rotated on both the camera's LCD monitor and on the personal computer.

- **On** 

The vertical image is automatically rotated only on the personal computer.

- **Off**

The vertical image is not rotated.

 Auto rotate will not work with vertical images captured while Auto rotate was set to [Off]. They will not rotate even if you later switch it to [On] for playback.

-  Immediately after image capture, the vertical image will not be automatically rotated for the image review.
- If the vertical image is taken while the camera is pointed up or down, the image might not rotate automatically for playback.
- If the vertical image is not automatically rotated on the personal computer screen, it means the software you are using is unable to rotate the image. Using the provided software is recommended.

9

Sensor Cleaning

The camera has a Self Cleaning Sensor Unit attached to the image sensor's front layer (low-pass filter) to shake off dust automatically.

The Dust Delete Data can also be appended to the image so that the dust spots remaining can be erased automatically by Digital Photo Professional (provided software).

About smear adhering to the front of the sensor

Besides dust entering the camera from outside, in rare cases lubricant from the camera's internal parts may adhere to the front of the sensor. In case visible spots still remain after the automatic sensor cleaning, having the sensor cleaned by a Canon Service Center is recommended.



Even while the Self Cleaning Sensor Unit is operating, you can press the shutter button halfway to interrupt the cleaning and start shooting immediately.

Automatic Sensor Cleaning

Whenever you set the power switch to <ON> or <OFF>, the Self Cleaning Sensor Unit operates to automatically shake off the dust on the front of the sensor. Normally, you need not pay attention to this operation. However, you can execute the sensor cleaning at anytime as well as disable it.

Cleaning the Sensor Now





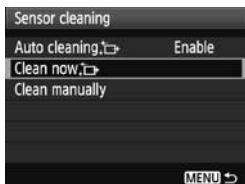

1 Select [Sensor cleaning].

- Under the [] tab, select [**Sensor cleaning**], then press <SET>.



2 Select [Clean now].

- Turn the < > dial to select [**Clean now **], then press <SET>.
- Select [**OK**] on the dialog screen, then press <SET>.
- ▶ The screen will indicate that the sensor is being cleaned. Although there will be a shutter sound, a picture is not taken.

-  ● For best results, do the sensor cleaning while the camera bottom is placed on a table or other flat surface.
- Even if you repeat the sensor cleaning, the result will not improve that much. Right after the sensor cleaning is finished, the [**Clean now **] option will remain disabled temporarily.

Disabling Automatic Sensor Cleaning

- In step 2, select [**Auto cleaning **] and set it to [**Disable**].
- ▶ The sensor cleaning will no longer be executed when you set the power switch to <ON> or <OFF>.

MENU Appending Dust Delete Data ☆

Normally, the Self Cleaning Sensor Unit will eliminate most of the dust that might be visible on captured images. However, in case visible dust still remains, you can append the Dust Delete Data to the image to later erase the dust spots. The Dust Delete Data is used by Digital Photo Professional (provided software) to erase the dust spots automatically.

Preparation

- Get a solid-white object (paper, etc.).
- Set the lens focal length to 50mm or longer.
- Set the lens focus mode switch to **<MF>** and set the focus to infinity (∞). If the lens has no distance scale, look at the front of the lens and turn the focusing ring clockwise all the way.

Obtain the Dust Delete Data



1 Select [Dust Delete Data].

- Under the [Df] tab, select [Dust Delete Data], then press **<SET>**.

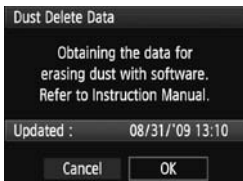

2 Select [OK].

- Turn the **<DISP>** dial to select [OK], then press **<SET>**. After the automatic sensor cleaning ends, a message will appear. Although there will be a shutter sound, a picture is not taken.

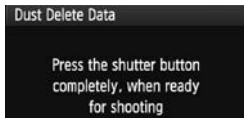



3 Photograph a solid-white object.

- At a distance of 20 cm - 30 cm / 0.7 ft. - 1.0 ft., fill the viewfinder with a patternless, solid-white object and take a picture.
- ▶ The picture will be taken in the aperture-priority AE mode with an aperture of f/22.
- Since the image will not be saved, the data can still be obtained even if there is no card in the camera.
- ▶ When the picture is taken, the camera will start obtaining the Dust Delete Data. When the Dust Delete Data is obtained, a message will appear. Select [OK], and the menu will reappear.
- If the data was not obtained successfully, a message to that effect will appear. Follow the "Preparation" procedure on the preceding page, then select [OK]. Take the picture again.

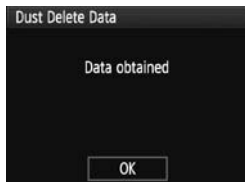

About the Dust Delete Data

After the Dust Delete Data is obtained, it is appended to all the JPEG and RAW images captured thereafter. Before an important shoot, you should update the Dust Delete Data by obtaining it again.

To erase dust spots automatically with the provided software, see the Software Instruction Manual in the CD-ROM.

The Dust Delete Data appended to the image is so small that it hardly affects the image file size.

! Be sure to use a solid-white object such as a new sheet of white paper. If the paper has any pattern or design, it may be recognized as dust data and affect the accuracy of the dust deletion with the software.

MENU Manual Sensor Cleaning [☆]

Dust which could not be removed by the automatic sensor cleaning can be removed manually with a blower, etc.

The surface of the image sensor is extremely delicate. If the sensor needs to be cleaned directly, having it done by a Canon Service Center is recommended.

Before cleaning the sensor, detach the lens from the camera.



1 Select [Sensor cleaning].

- Under the [] tab, select [**Sensor cleaning**], then press <SET>.

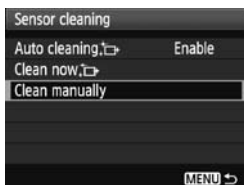

2 Select [Clean manually].

- Turn the < > dial to select [**Clean manually**], then press <SET>.



3 Select [OK].

- Turn the < > dial to select [**OK**], then press <SET>.
- ▶ In a moment, the reflex mirror will lockup and the shutter will open.
- “CLn” will blink on the LCD panel.

4 End the cleaning.

- Set the power switch to <OFF>.



- As the power source, using the AC Adapter Kit ACK-E6 (sold separately) is recommended.
- If you use the battery, make sure it is fully recharged. If a battery grip with size-AA/LR6 batteries is attached, manual sensor cleaning will not be possible.

- **While cleaning the sensor, never do any of the following. Doing any of the following will cut off the power and close the shutter. The shutter curtains and image sensor might get damaged.**
 - **Setting the power switch to <OFF>.**
 - **Opening the battery compartment cover.**
 - **Opening the card slot cover.**
- The surface of the image sensor is extremely delicate. Clean the sensor with care.
- Use a plain blower without any brush attached. A brush can scratch the sensor.
- Do not insert the blower tip inside the camera beyond the lens mount. If the power is turned off, the shutter will close and the shutter curtains or reflex mirror might get damaged.
- Never use canned air or gas to clean the sensor. The blowing force can damage the sensor or the spray gas can freeze on the sensor.
- If smear that cannot be removed with a blower remains, having the sensor cleaned by a Canon Service Center is recommended.

10

Printing Images

- **Printing** (p.190)
You can connect the camera directly to a printer and print out the images in the card. The camera is compatible with “PictBridge” which is the standard for direct printing.
- **Digital Print Order Format (DPOF)** (p.199)
DPOF (Digital Print Order Format) enables you to print images recorded in the card according to your printing instructions such as the image selection, quantity to print, etc. You can print multiple images in one batch or give the print order to a photofinisher.

Preparing to Print

The direct printing procedure is done entirely with the camera while you look at the LCD monitor.

Connecting the Camera to a Printer

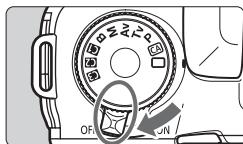

- 1 Set the camera's power switch to <OFF>.

- 2 Set up the printer.

- For details, see the printer's instruction manual.

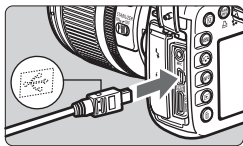

- 3 Connect the camera to the printer.

- Use the interface cable provided with the camera.
- When connecting the cable plug to the camera's <A/V OUT/DIGITAL> terminal, the cable plug's <↔> icon must face the front side of the camera.
- To connect to the printer, refer to the printer's instruction manual.

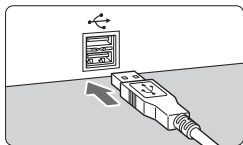

- 4 Turn on the printer.

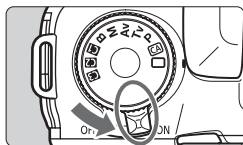

- 5 Set the camera's power switch to <ON>.

- ▶ Some printers may make a beeping sound.

PictBridge



6 Playback the image.

- Press the <▶> button.
- ▶ The image will appear, and the <📷> icon will appear on the upper left to indicate that the camera is connected to a printer.



- Movies cannot be printed.
- The camera cannot be used with printers compatible only with CP Direct or Bubble Jet Direct.
- Do not use any interface cable other than the one provided.
- If there is a long beeping sound in step 5, it indicates a problem with the printer. To find out what's wrong, do the following:
 1. Press the <▶> button to playback the image.
 2. Press <SET>.
 3. On the print setting screen, select **[Print]**.
 The error message will be displayed on the LCD monitor (p.198).



- You can also print RAW images taken by this camera.
- If you use the battery to power the camera, make sure it is fully charged. With a fully-charged battery, printing up to about 4 hours is possible.
- Before disconnecting the cable, turn off the camera and printer first. Hold the plug (not the cord) to pull out the cable.
- For direct printing, using the AC Adapter Kit ACK-E6 (sold separately) to power the camera is recommended.

Printing

The screen display and setting options will differ depending on the printer. Some settings might not be available. For details, see the printer's instruction manual.

Printer-connected icon



1 Select the image to be printed.

- Check that the <☞> icon is displayed on the upper left of the LCD monitor.
- Turn the <⊙> dial to select the image to be printed.

2 Press <SET>.

- ▶ The print setting screen will appear.

Print setting screen



Sets the printing effects (p.194).

Sets the date or file number imprinting to on or off.

Sets the quantity to be printed.

Sets the trimming (cropping) (p.197).

Sets the paper size, type, and layout.

Returns to the screen in step 1.

Starts the printing.

The paper size, type, and layout you have set are displayed.

* Depending on the printer, some settings such as the date and file number imprinting and trimming might not be available.

3 Select [Paper settings].

- Select [Paper settings], then press <SET>.
- ▶ The paper settings screen will appear.

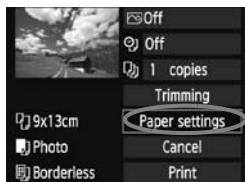

Setting the Paper Size

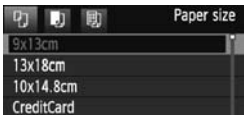

- Select the size of the paper loaded in the printer, then press **<SET>**.
- ▶ The paper type screen will appear.

Setting the Paper Type

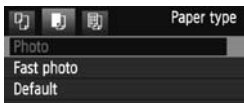

- Select the type of the paper loaded in the printer, then press **<SET>**.
- When using a Canon printer and Canon paper, read the printer's instruction manual to check what paper types can be used.
- ▶ The page layout screen will appear.

Setting the Page Layout



- Select the page layout, then press **<SET>**.
- ▶ The print setting screen will reappear.

Bordered	The print will have white borders along the edges.
Borderless	The print will have no white borders. If your printer cannot print borderless prints, the print will have borders.
Bordered [i]	The shooting information* will be imprinted on the border on 9x13cm and larger prints.
xx-up	Option to print 2, 4, 8, 9, 16, or 20 images on one sheet.
20-up [i] 35-up [i]	On A4 or Letter size paper, 20 or 35 thumbnails of the images ordered through DPOF (p.199) will be printed. • [20-up [i]] will have the shooting information* imprinted.
Default	The page layout will vary depending on the printer model or its settings.

* From the Exif data, the camera name, lens name, shooting mode, shutter speed, aperture, exposure compensation amount, ISO speed, white balance, etc., will be imprinted.



4 Set the printing effects.

- Set as necessary. If you need not set any printing effects, go to step 5.
- **The screen display may differ depending on the printer.**
- Select the option on the upper right (circled in the screenshot), then press **<SET>**.
- Select the desired printing effect, then press **<SET>**.
- If the **<INFO>** icon is displayed next to **<INFO>**, you can also adjust the printing effect (p.196).

Printing Effect	Description
On	The image will be printed according to the printer's standard colors. The image's Exif data is used to make automatic corrections.
Off	No automatic correction will be performed.
Vivid	The image will be printed with higher saturation to produce more vivid blues and greens.
NR	The image noise is reduced before printing.
B/W B/W	Prints in black-and-white with true blacks.
B/W Cool tone	Prints in black-and-white with cool, bluish blacks.
B/W Warm tone	Prints in black-and-white with warm, yellowish blacks.
Natural	Prints the image in the actual colors and contrast. No automatic color adjustments will be applied.
Natural M	The printing characteristics are the same as the "Natural" setting. However, this setting enables finer printing adjustments than with "Natural."
Default	The printing will differ depending on the printer. For details, see the printer's instruction manual.

* When you change the printing effects, it is reflected in the image displayed on the upper left. Note that the printed image might look slightly different from the displayed image which is only an approximation. This also applies to [Brightness] and [Adjust levels] on page 196.



5 Set the date and file number imprinting.

- Set as necessary.
- Select <[Imprinting]>, then press <[SET]>.
- Set as desired, then press <[SET]>.

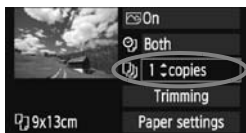

6 Set the number of copies.

- Set as necessary.
- Select <[Copies]>, then press <[SET]>.
- Set the number of copies, then press <[SET]>.



7 Start printing.

- Select [Print], then press <[SET]>.



- With Easy printing, you can print another image with the same settings. Just select the image and press the <[Print]> button. With Easy printing, the number of copies will always be 1. (You cannot set the number of copies.) Also, any trimming (p.197) will not be applied.
- The [Default] setting for printing effects and other options are the printer's own default settings as set by the printer's manufacturer. See the printer's instruction manual to find out what the [Default] settings are.
- Depending on the image's file size and image-recording quality, it may take some time for the printing to start after you select [Print].
- If image tilt correction (p.197) has been applied, it will take longer to print the image.
- To stop the printing, press <[SET]> while [Stop] is displayed, then select [OK].
- If you execute [P: Clear all camera settings] (p.45) menu, all the settings will revert to the default.

Adjustment of Printing Effects





In step 4 on page 194, select the printing effect. When the  icon is displayed next to **<INFO.>**, press the **<INFO.>** button. You can then adjust the printing effect. What can be adjusted or what is displayed will depend on the selection made in step 4.

- **Brightness**

The image brightness can be adjusted.

- **Adjust levels**

When you select [**Manual**], you can change the histogram's distribution and adjust the image's brightness and contrast.

With the Adjust levels screen displayed, press the **<INFO.>** button to change the position of the . Turn the  dial to freely adjust the shadow level (0 - 127) or highlight level (128 - 255).

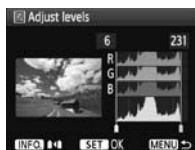



-  **Brightener**

Effective in backlit conditions which can make the subject's face look dark. When [**On**] is set, the face will be brightened for printing.

- **Red-eye corr.**

Effective in flash images where the subject has red eye. When [**On**] is set, the red eye will be corrected for printing.

- The [ **Brightener**] and [**Red-eye corr.**] effects will not show on the screen.
- When you select [**Detail set.**], you can adjust the [**Contrast**], [**Saturation**], [**Color tone**], and [**Color balance**]. To adjust the [**Color balance**], use . B is for blue, A is amber, M is magenta, and G is green. The color in the respective direction will be corrected.
- If you select [**Clear all**], all the printing effect settings will be reverted to the default.

Trimming the Image



You can crop the image and print only the trimmed portion as if the image was recomposed. **Do the trimming right before printing.** If you set the trimming and then set the print settings, you may have to set the trimming again.

1 On the print setting screen, select [Trimming].

2 Set the trimming frame size, position, and aspect ratio.

- The image area within the trimming frame will be printed. The trimming frame's aspect ratio can be changed with [Paper settings].

Changing the trimming frame size

When you press the or button, the size of the trimming frame will change. The smaller the trimming frame, the larger the image magnification will be for printing.

Moving the trimming frame

Use to move the frame over the image vertically or horizontally. Move the trimming frame until it covers the desired image area.

Rotating the frame

Each time you press the <INFO.> button, the trimming frame will toggle between the vertical and horizontal orientations. This enables you to create a vertical-oriented print from a horizontal image.

Image tilt correction

By turning the dial, you can adjust the image tilt angle up to ± 10 degrees in 0.5-degree increments. When you adjust the image tilt, the icon on the screen will turn blue.

3 Press <SET> to exit the trimming.

- ▶ The print setting screen will reappear.
- You can check the trimmed image area on the upper left of the print setting screen.

- Depending on the printer, the trimmed image area might not be printed as you specified.
- The smaller you make the trimming frame, the grainier the picture will look on the print.
- While trimming the image, look at the camera's LCD monitor. If you look at the image on a TV screen, the trimming frame might not be displayed accurately.



Handling Printer Errors

If you resolve a printer error (no ink, no paper, etc.) and select [**Continue**] to resume printing but it does not resume, operate the buttons on the printer to resume printing. For details, see the printer's instruction manual.

Error Messages

If a problem occurs during printing, an error message will appear on the camera's LCD monitor. Press <ⓈET> to stop printing. After fixing the problem, resume printing. For details on how to fix a printing problem, refer to the printer's instruction manual.

Paper Error

Check whether the paper is properly loaded in the printer.

Ink Error

Check the printer's ink level, and check the waste ink tank.

Hardware Error

Check for any printer problems other than paper and ink problems.

File Error

The selected image cannot be printed via PictBridge. Images taken with a different camera or images edited with a computer might not be printable.

Digital Print Order Format (DPOF)

You can set the print type, date imprinting, and file No. imprinting. The print settings will be applied to all print-ordered images. (They cannot be set individually for each image.)

Setting the Printing Options



1 Select [Print order].

- ▶ Under the [] tab, select [Print order], then press <SET>.

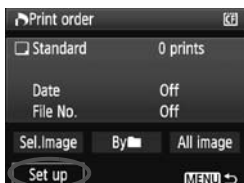

2 Select [Set up].

- Select [Set up], then press <SET>.

3 Set the option as desired.

- Set the [Print type], [Date], and [File No.].
- Select the option, then press <SET>. Select the setting, then press <SET>.

[Print type]

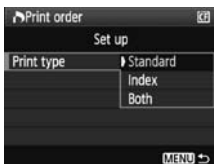

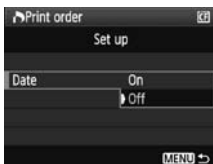

[Date]



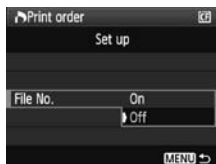

[File No.]



Print type	 Standard	Prints one image on one sheet.
	 Index	Multiple, thumbnail images are printed on one sheet.
	 Both	Prints both the standard and index prints.
Date	On	[On] imprints the recorded date on the print.
	Off	
File number	On	[On] imprints the file No. on the print.
	Off	

4 Exit the setting.

- Press the <MENU> button.
- ▶ The print order screen will reappear.
- Next, select [**Sel.Image**], [**By** ], or [**All image**] to order the images to be printed.

- 
- Even if [**Date**] and [**File No.**] are set to [**On**], the date or file No. might not be imprinted depending on the print type setting and printer model.
 - When printing with DPOF, you must use the card whose print order specifications have been set. It will not work if you just extract images from the card and try to print them.
 - Certain DPOF-compatible printers and photofinishers might not be able to print the images as you specified. If this happens with your printer, refer to the printer's instruction manual. Or check with your photofinisher about compatibility when ordering prints.
 - Do not insert into the camera a card whose print order was set by a different camera and then try to specify a print order. The print order may not work or may be overwritten. Also, depending on the image type, the print order may not be possible.

- 
- RAW images and movies cannot be print ordered.
 - With [**Index**] prints, both the [**Date**] and [**File No.**] cannot be set to [**On**] at the same time.

Print Ordering

● Sel. Image



Select and order images one by one. To display the three-image view, press the < [Grid Icon] [Magnifying Glass Icon] > button. To return to the single-image view, press the < [Magnifying Glass Icon] > button.

After completing the print order, press the < MENU > button to save the print order to the card.



Quantity

Total images
selected

[Standard] [Both]

Press < [SET] > and a print order for 1 copy of the displayed image will be placed. Then turn the < [Dial] > dial to set the number of copies (up to 99) to be printed for that image.



Check mark

Index icon

[Index]

Press < [SET] >, and the displayed image will be included in the index print. The < [Checkmark Icon] > icon will also appear on the upper left.

● By [Folder Icon]

Select [By [Folder Icon]] and select the folder. A print order for 1 copy of all the images in the folder will be placed. If you select Clear all and a folder, the print order for all the images in the folder will be canceled.

● All image

A print order for 1 copy of all the images in the card will be placed. If you select Clear all, the print order for all the images in the card will be canceled.



- Note that RAW images and movies will not be included in the print order even if you set “By [Folder Icon]” or “All image.”
- When using a PictBridge printer, print no more than 400 images for one print order. If you specify more than this, all the images might not be printed.

Direct Printing with DPOF



With a PictBridge printer, you can easily print images with DPOF.

1 Preparing to print.

- See page 190. Follow the “Connecting the Camera to a Printer” procedure up to step 5.

2 Under the [] tab, select [Print order].

3 Select [Print].

- [Print] will be displayed only if the camera is connected to the printer and printing is possible.

4 Set the [Paper settings]. (p.192)

- Set the printing effects (p.194) if necessary.

5 Select [OK].

- Before printing, be sure to set the paper size.
- Certain printers cannot imprint the file No.
- If [Bordered] is set, the date might be imprinted on the border, depending on the printer.
- Depending on the printer, the date might look light if it is imprinted on a bright background or on the border.

- Under [Adjust levels], [Manual] cannot be selected.
- If you stopped the printing and want to resume printing the remaining images, select [Resume]. Note that printing will not resume if you stop the printing and any of the following occurs:
 - Before resuming the printing, you changed the print order or deleted print-ordered images.
 - When you set the index, you changed the paper setting before resuming the printing.
 - When you paused the printing, the card's remaining capacity was low.
- If a problem occurs during printing, see page 198.

11

Customizing the Camera

With Custom Functions, you can change the camera functions to suit your preferences. Also, the current camera settings can be saved under the Mode Dial's <C1>, <C2>, and <C3> positions.

The features explained in this chapter can be set and used in the following shooting modes: **P**, **Tv**, **Av**, **M**, **B**.

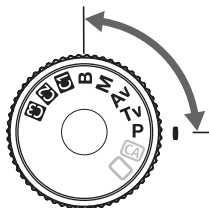

MENU Setting Custom Functions ☆

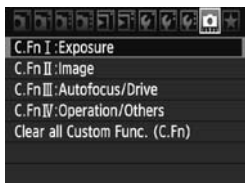

- 1 Select [MENU].**
- Turn the < [MENU] > dial to select the [MENU] tab.

- 2 Select the group.**
- Turn the < [GROUP] > dial to select C.Fn I - IV, then press < [SET] >.

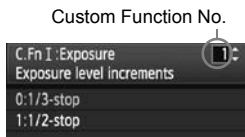

- 3 Select the Custom Function number.**

- Turn the < [NUMBER] > dial to select the Custom Function No., then press < [SET] >.

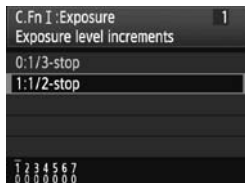

- 4 Change the setting as desired.**

- Turn the < [NUMBER] > dial to select the setting (number), then press < [SET] >.
- Repeat steps 2 to 4 if you want to set other Custom Functions.
- At the bottom of the screen, the current Custom Function settings are indicated below the respective function numbers.

- 5 Exit the setting.**

- Press the < MENU > button.
- ▶ The screen for step 2 will reappear.



Clearing All Custom Functions

In step 2, select [Clear all Custom Func. (C.Fn)] to clear all the Custom Function settings.

MENU Custom Functions [☆]

C.Fn I: Exposure

1	Exposure level increments	p.206
2	ISO speed setting increments	
3	ISO expansion	
4	Bracketing auto cancel	
5	Bracketing sequence	p.207
6	Safety shift	
7	Flash sync. speed in Av mode	

 LV shooting	 Movie shooting
<input type="radio"/>	<input type="radio"/>
<input type="radio"/>	<input type="radio"/> (<M>)
<input type="radio"/>	<input type="radio"/>
<input type="radio"/>	
<input type="radio"/>	
<input type="radio"/>	

C.Fn II: Image

1	Long exposure noise reduction	p.208
2	High ISO speed noise reduction	
3	Highlight tone priority	p.209

<input type="radio"/>	<input type="radio"/> (Stills)
<input type="radio"/>	<input type="radio"/> (Stills)
<input type="radio"/>	<input type="radio"/>

C.Fn III: Autofocus/Drive

1	AI Servo tracking sensitivity	p.209
2	AI Servo 1st/2nd image priority	p.210
3	AI Servo AF tracking method	
4	Lens drive when AF impossible	p.211
5	AF Microadjustment	
6	Select AF area selection mode	p.212
7	Manual AF point selection pattern	
8	VF display illumination	p.213
9	Display all AF points	
10	Focus display in AI SERVO/MF	
11	AF-assist beam firing	p.214
12	Orientation linked AF point	
13	Mirror lockup	p.215

<input type="radio"/> (AFQuick)	
<input type="radio"/> (AFQuick)	
<input type="radio"/> (AFQuick)	
<input type="radio"/> (AFQuick)	
<input type="radio"/> (AFQuick)	
<input type="radio"/> (AFQuick)	

C.Fn IV: Operation/Others

1	Custom Controls	p.215
2	Dial direction during Tv/Av	
3	Add image verification data	p.216
4	Add aspect ratio information	

As set	
<input type="radio"/>	<input type="radio"/> (<M>)
<input type="radio"/>	<input type="radio"/> (Stills)
<input type="radio"/>	<input type="radio"/> (Stills)



The shaded Custom Functions do not function during Live View (Live View shooting) and/or movie shooting. (Settings are disabled.)

MENU Custom Function Settings ☆

C.Fn I: Exposure

C.Fn I -1 Exposure level increments

0: 1/3-stop

1: 1/2-stop

Sets 1/2-stop increments for the shutter speed, aperture, exposure compensation, AEB, flash exposure compensation, etc. Effective when you prefer to control the exposure in less fine increments than 1/3-stop increments.

 The exposure level will be displayed in the viewfinder and on the LCD panel as shown below.



C.Fn I -2 ISO speed setting increments

0: 1/3-stop

1: 1-stop

C.Fn I -3 ISO expansion

0: Off

1: On

For the ISO speed, "H" (equivalent to ISO 12800) will be selectable.

C.Fn I -4 Bracketing auto cancel

0: On

The AEB and WB-BKT settings will be canceled if you set the power switch to <OFF> or clear the camera settings. AEB will also be canceled when the flash is ready to fire.

1: Off

The AEB and WB-BKT settings will be retained even when the power switch is set to <OFF>. (When the flash is ready, AEB will be canceled. However, the AEB amount will be retained in memory.)

C.Fn I -5 Bracketing sequence

The AEB shooting sequence and white balance bracketing sequence can be changed.

0: 0, -, +

1: -, 0, +

AEB	WB Bracketing	
	B/A Direction	M/G Direction
0 : Standard exposure	0 : Standard white balance	0 : Standard white balance
- : Decreased exposure	- : Blue bias	- : Magenta bias
+ : Increased exposure	+ : Amber bias	+ : Green bias

C.Fn I -6 Safety shift

0: Disable

1: Enable (Tv/Av)

This works in the shutter-priority AE (**Tv**) and aperture-priority AE (**Av**) modes. When the subject's brightness changes erratically and the correct autoexposure cannot be obtained, the camera will change the exposure setting automatically to obtain a correct exposure.

C.Fn I -7 Flash sync. speed in Av mode

0: Auto

Normally, the sync speed will be set automatically within 1/250 sec. to 30 sec. High-speed sync can also take effect.

1: 1/250-1/60 sec. auto

When flash is used with aperture-priority AE (**Av**), this prevents a slow flash-sync speed from being set automatically in low-light conditions. It is effective for preventing subject blur and camera shake. However, while the subject will be properly exposed with the flash, the background will come out dark.

2: 1/250 sec. (fixed)

The flash-sync speed is fixed to 1/250 sec. This more effectively prevents subject blur and camera shake than with setting 1. However, the background will come out darker than with setting 1.

C.Fn II: Image

C.Fn II -1 Long exposure noise reduction

0: Off

1: Auto

For 1 sec. or longer exposures, noise reduction is performed automatically if noise typical of long exposures is detected. This [**Auto**] setting is effective in most cases.

2: On

Noise reduction is performed for all exposures of 1 sec. or longer. The [**On**] setting may be effective for noise that cannot be detected or reduced with the [**Auto**] setting.

- With setting 1 and 2, after the picture is taken, the noise reduction process may take the same amount of time as the exposure. You cannot take another picture until the noise reduction process is completed.
- At ISO 1600 and higher, noise might be more pronounced with setting 2 than with setting 0 or 1.
- With setting 2, if a long exposure is used during Live View shooting, "BUSY" will be displayed and the Live View display will not appear until the noise reduction process is completed. (You cannot take another picture.)

C.Fn II -2 High ISO speed noise reduction

Reduces the noise generated in the image. Although noise reduction is applied at all ISO speeds, it is particularly effective at high ISO speeds. At low ISO speeds, the noise in the shadow areas is further reduced. Change the setting to suit the noise level.

0: Standard

2: Strong

1: Low

3: Disable

- With setting 2, the maximum burst for continuous shooting will greatly decrease.
- If you playback a RAW or RAW+JPEG image with the camera or print the image directly, the effect of the high ISO speed noise reduction may look minimal. You can check the noise reduction effect or print noise-reduced images with Digital Photo Professional (provided software).

C.Fn II -3 Highlight tone priority

0: Disable

1: Enable

Improves the highlight detail. The dynamic range is expanded between the standard 18% gray and bright highlights. The gradation between the grays and highlights becomes smoother.



- With setting 1, the [**Disable**] setting automatically takes effect for the Auto Lighting Optimizer (p.75) and it cannot be changed.
- With setting 1, noise in the shadow areas may be slightly more than usual.



With setting 1, the settable ISO speed range will be 200 - 6400. Also, <D+> will be displayed on the LCD panel and in the viewfinder.

C.Fn III: Autofocus/Drive

C.Fn III -1 AI Servo tracking sensitivity

During focusing in AI Servo AF mode, the AF sensitivity for tracking subjects (or obstacles) moving into AF points can be set to one of five levels.

If it is set toward [**Slow**], interruptions by any obstacles will be less disruptive. It makes it easier to keep tracking the target subject.

If it is set toward [**Fast**], it will be easier to focus any subjects which suddenly enter the picture from the side. Convenient when you want to successively photograph multiple subjects located at random distances.

C.Fn III -2 AI Servo 1st/2nd image priority

For the AI Servo AF and continuous shooting modes, you can change the Servo's operation characteristics and shutter-release timing.

0: AF priority/Tracking priority

For the first shot, focusing the subject is given priority. For the 2nd and following shots during continuous shooting, focus-tracking of the subject is given priority.

1: AF priority/Drive speed priority

For the first shot, focusing the subject is given priority. During continuous shooting, the continuous shooting speed is given priority over the focus-tracking of the subject.

2: Release/Drive speed priority

For the first shot, shutter release is given priority over focusing the subject. During continuous shooting, the continuous shooting speed is given priority more than with setting 1.

3: Release/Tracking priority

For the first shot, shutter release is given priority over focusing the subject. For the 2nd and following shots during continuous shooting, focus-tracking of the subject is given priority.

C.Fn III -3 AI Servo AF tracking method

In the AI Servo AF mode while you are focus-tracking a subject, the camera can either continue focusing the target subject even if a closer subject (closer than at the main focus point) suddenly appears in the picture, or the camera can switch to focus the closer subject.

* Main focus point: With 19-point AF auto selection and AF point expansion, this is the first AF point which started the focusing. With Zone AF, this is the active AF point.

0: Main focus point priority

The active AF point will switch to the main focus point and start focusing the closer subject. Convenient when you always want to focus the closest subject.

1: Continuous AF track priority

Any closer subject appearing in the picture will be ignored as an obstruction. The main focus point does not take priority, so the tracking of the target subject can continue and switch to an adjacent AF point based on the preceding focusing result. Convenient when obstacles such as telephone poles go in front of the target subject.

C.Fn III -4 Lens drive when AF impossible

If autofocus is executed, but focus cannot be achieved, the camera can either keep trying to focus or stop.

0: Focus search on

1: Focus search off

Prevents the camera from becoming grossly out of focus as it attempts to focus again. Especially convenient with super telephoto lenses which can become extremely out of focus.

C.Fn III -5 AF Microadjustment

Normally, this adjustment is not required. Do this adjustment only if necessary. Note that doing this adjustment may prevent correct focusing from being achieved.

C.Fn III :Autofocus/Drive	5
AF Microadjustment	AF
0:Disable	
1:Adjust all by same amount	±0
2:Adjust by lens	±0

You can make fine adjustments for the AF's point of focus. It can be adjusted in ± 20 steps (-: Forward / +: Backward).

The adjustment amount of one step varies depending on the maximum aperture of the lens.

Adjust, shoot (▲ L), and check the focus. Repeat to adjust the AF's point of focus.

With setting 1 or 2 selected, press the <INFO.> button to view the register screen. To cancel all the registered adjustments, press the <☒> button.

0: Disable

1: Adjust all by same amount

The same adjustment amount is applied to all lenses.

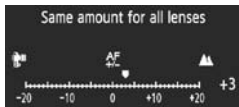

2: Adjust by lens

An adjustment can be set individually for any particular lens. Adjustments for up to 20 lenses can be registered in the camera.

When a lens whose focus adjustment has been registered is attached to the camera, its point of focus will be shifted accordingly.

If adjustments for 20 lenses have already been registered and you want to register an adjustment for another lens, select a lens whose adjustment can be overwritten or deleted.



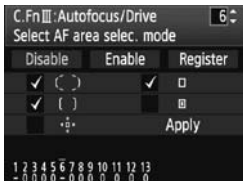

- It is best to make the adjustment at the actual place where you will shoot. This will make the adjustment more precise.
- With setting 2, if an Extender is used, the adjustment will be registered for the lens and Extender combination.
- The registered AF microadjustments will be retained even if you use the Custom Function to clear all settings (p.204). However, the setting itself will be [0: Disable].
- AF adjustment cannot be done during Live View shooting in Live and  Live modes.

C.Fn III -6 Select AF area selection mode



Make the mode selectable by selecting **[Register]**, then pressing <SET>.

Turn the <> dial to select the mode to be used, then press <SET> to append a <> checkmark.

After making the selection, turn the <> dial to select **[Apply]**, then press <SET>.

If you select **[Enable]** and press <SET>, only the modes with the <> checkmark will be selectable.

If you select **[Disable]** and press <SET>, the default setting will make 19 point AF, Zone AF (Manual select), and Single point AF selectable.

C.Fn III -7 Manual AF point selection pattern

During manual AF point selection, the selection can either stop at the outer edge or it can go on to the opposite AF point. This is effective for all the AF area selection modes except for 19 point AF auto selection and Zone AF.

0: Stops at AF area edges

Convenient if you often use an AF point along the edge.

1: Continuous

Instead of stopping at the edge, the AF point selection continues to the opposite edge.

C.Fn III -8 VF display illumination

The AF points, grid, etc., in the viewfinder can be illuminated in red.

0: Auto

The viewfinder illumination turns on automatically under low light.

1: Enable

The viewfinder illumination turns on regardless of the ambient light level.

2: Disable**C.Fn III -9 Display all AF points****0: Disable**

During the AF point selection, all the AF points are displayed. When shooting, only the active AF point(s) is(are) displayed.

1: Enable

As during AF point selection, all the AF points are displayed when shooting.

C.Fn III -10 Focus display in AI SERVO/MF**0: Enable**

When AI Servo AF is set with Zone AF and 19-point AF auto selection, the AF point(s) <□> which focuses will focus-track the subject.

With manual focus, when focus is achieved, the focus confirmation indicator will be the same as with AF.

1: Disable

Even when focus is achieved with manual focus, there will be no focus confirmation indicator.

With AI Servo AF used with AF point expansion, Zone AF, or 19-point AF auto selection, the AF point(s) <□> tracking the subject is not displayed.

C.Fn III -11 AF-assist beam firing

The AF-assist beam can be emitted by the camera's built-in flash or by an external, EOS-dedicated Speedlite.

0: Enable

1: Disable

The AF-assist beam is not emitted.

2: Enable external flash only

If an external, EOS-dedicated Speedlite is attached, it will emit the AF-assist beam when necessary.

3: IR AF assist beam only

Among EOS-dedicated Speedlites, only those which have an infrared AF-assist beam will be able to emit the beam. This prevents any Speedlite which uses a series of small flashes (like the built-in flash) from firing the AF-assist beam.



If the external, EOS-dedicated Speedlite's **[AF-assist beam firing]** Custom Function is set to **[Disabled]**, the Speedlite will not emit the AF-assist beam even if the camera's C.Fn III -11-0/2/3 is set.

C.Fn III -12 Orientation linked AF point

The AF area selection mode and manually-selected AF point (or Zone selected with Zone AF) can be set separately for the vertical and horizontal orientations.

0: Same for both vertical/horizontal

The same AF area selection mode and manually-selected AF point (or Zone selected with Zone AF) are used for both orientations.

1: Select different AF points

The AF area selection mode and manually-selected AF point (or Zone selected with Zone AF) can be set separately for each camera orientation (1. Horizontal, 2. Vertical with the camera grip at the top, 3. Vertical with the camera grip at the bottom). Convenient when, for instance, you want to keep using the right AF point during all camera orientations.

Setting procedure

Manually select and set the AF selection mode and AF point (or Zone with Zone AF) for each camera orientation (1. Horizontal, 2. Vertical with the camera grip at the top, 3. Vertical with the camera grip at the bottom). When this is set, the camera will switch to the AF area selection mode and manually-selected AF point (or Zone selected with Zone AF) to suit each camera orientation.

C.Fn III -13 Mirror lockup

0: Disable

1: Enable

Prevents camera vibrations caused by the reflex mirror action that can disturb shooting with super telephoto lenses or close-up (macro) shooting. See page 109 for the mirror lockup procedure.

C.Fn IV: Operation/Others

C.Fn IV -1 Custom Controls





You can assign often-used functions to camera buttons or dials according to your preferences. You can also change the function of the Main Dial, Quick Control Dial, and . For details, see page 217.

C.Fn IV -2 Dial direction during Tv/Av

0: Normal

1: Reverse direction

The dial's turning direction for setting the shutter speed and aperture can be reversed.

In the manual exposure mode, the direction of the  and  dials will be reversed. In other shooting modes, the  dial will be reversed. The direction of the  dial will be the same in the manual exposure mode and for setting exposure compensation.

C.Fn IV -3 Add image verification data**0: Disable****1: Enable**

Data for verifying whether the image is original or not is appended to the image automatically. When the shooting information of an image appended with the verification data is displayed (p.163), the  icon will appear.

To verify whether the image is original, the Original Data Security Kit OSK-E3 (sold separately) is required.

 The images are not compatible with the image encryption/decryption features of Original Data Security Kit OSK-E3.

C.Fn IV -4 Add aspect ratio information

During Live View shooting, vertical lines corresponding to the aspect ratio will be displayed. You can thereby simulate framing for medium- and large-format film sizes such as 6x6 cm, 6x4.5 cm, and 4x5 in.

This aspect ratio information will be appended automatically to the captured image. (The image will not actually be saved to the memory card as a cropped image.)

When the image is transferred to a personal computer and the Digital Photo Professional (provided software) is used, the image will be displayed in the aspect ratio you specified.

0: Off**4: Aspect ratio 6:7****1: Aspect ratio 6:6****5: Aspect ratio 10:12****2: Aspect ratio 3:4****6: Aspect ratio 5:7****3: Aspect ratio 4:5**

-  ● Aspect ratio information will also be appended if you shoot through the viewfinder.
- During image playback on the camera, vertical lines for the respective ratio will be displayed.

C.Fn IV -1: Custom Controls

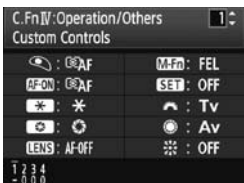

1 Select [INFO] C.Fn IV -1: Custom Controls].

- A list of camera controls and their assigned functions will appear (p.218).
- When you press <SET>, the camera controls setting screen will appear.



2 Select the camera button or dial.

- Turn the <DIAL> dial to select the button/dial, then press <SET>.
- ▶ The name of the camera control and the assignable functions will be displayed.

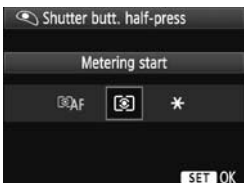

3 Assign a function.

- Turn the <DIAL> dial to select the desired function, then press <SET>.
- If the [INFO.] icon appears on the bottom left, you can press the <INFO.> button and set other related options (p.219, 220). Select the desired option on the screen displayed, then press <SET>.



4 Exit the setting.

- When you press <SET> to exit the setting, the screen in step 2 will reappear.
- Press the <MENU> button to exit.

Assignable Functions to Camera Controls

Function		Page		AF-ON	*		LENS*	M-Fn	SET			
AF	AF	219	<input type="radio"/>	<input type="radio"/> *1	<input type="radio"/> *1	<input type="checkbox"/>	<input type="radio"/>	<input type="checkbox"/>	<input type="checkbox"/>	<input type="checkbox"/>	<input type="checkbox"/>	<input type="checkbox"/>
	AF-OFF		<input type="checkbox"/>	<input type="checkbox"/>	<input type="checkbox"/>	<input type="checkbox"/>	<input type="checkbox"/>	<input type="checkbox"/>	<input type="checkbox"/>	<input type="checkbox"/>	<input type="checkbox"/>	<input type="checkbox"/>
	AF↔		<input type="checkbox"/>	<input type="checkbox"/>	<input type="checkbox"/>	<input type="checkbox"/>	<input type="checkbox"/>	<input type="checkbox"/>	<input type="checkbox"/>	<input type="checkbox"/>	<input type="checkbox"/>	<input type="checkbox"/>
	<small>ONE SHOT AI SERVO</small> ONE SHOT AI SERVO ↔	220	<input type="checkbox"/>	<input type="checkbox"/>	<input type="checkbox"/>	<input type="checkbox"/>	<input type="checkbox"/>	<input type="checkbox"/>	<input type="checkbox"/>	<input type="checkbox"/>	<input type="checkbox"/>	<input type="checkbox"/>
	AF point direct selection		<input type="checkbox"/>	<input type="checkbox"/>	<input type="checkbox"/>	<input type="checkbox"/>	<input type="checkbox"/>	<input type="checkbox"/>	<input type="checkbox"/>	<input type="checkbox"/>	<input type="checkbox"/>	
Exposure	Metering start	220	<input type="radio"/>	<input type="checkbox"/>	<input type="checkbox"/>	<input type="checkbox"/>	<input type="checkbox"/>	<input type="checkbox"/>	<input type="checkbox"/>	<input type="checkbox"/>	<input type="checkbox"/>	<input type="checkbox"/>
	* AE lock		<input type="radio"/>	<input type="radio"/>	<input type="radio"/>	<input type="radio"/>	<input type="radio"/>	<input type="checkbox"/>	<input type="checkbox"/>	<input type="checkbox"/>	<input type="checkbox"/>	<input type="checkbox"/>
	FEL FE lock		<input type="checkbox"/>	<input type="checkbox"/>	<input type="checkbox"/>	<input type="checkbox"/>	<input type="checkbox"/>	<input type="checkbox"/>	<input type="checkbox"/>	<input type="checkbox"/>	<input type="checkbox"/>	<input type="checkbox"/>
	Tv Shutter speed setting in M mode		<input type="checkbox"/>	<input type="checkbox"/>	<input type="checkbox"/>	<input type="checkbox"/>	<input type="checkbox"/>	<input type="checkbox"/>	<input type="checkbox"/>	<input type="checkbox"/>	<input type="checkbox"/>	<input type="checkbox"/>
	Av Aperture setting in M mode		<input type="checkbox"/>	<input type="checkbox"/>	<input type="checkbox"/>	<input type="checkbox"/>	<input type="checkbox"/>	<input type="checkbox"/>	<input type="checkbox"/>	<input type="checkbox"/>	<input type="checkbox"/>	<input type="checkbox"/>
Image	Image quality	220	<input type="checkbox"/>	<input type="checkbox"/>	<input type="checkbox"/>	<input type="checkbox"/>	<input type="checkbox"/>	<input type="checkbox"/>	<input type="checkbox"/>	<input type="checkbox"/>	<input type="checkbox"/>	<input type="checkbox"/>
	<small>RAW JPEG</small> One-touch RAW+JPEG		<input type="checkbox"/>	<input type="checkbox"/>	<input type="checkbox"/>	<input type="checkbox"/>	<input type="checkbox"/>	<input type="checkbox"/>	<input type="checkbox"/>	<input type="checkbox"/>	<input type="checkbox"/>	
	Picture Style	221	<input type="checkbox"/>	<input type="checkbox"/>	<input type="checkbox"/>	<input type="checkbox"/>	<input type="checkbox"/>	<input type="checkbox"/>	<input type="checkbox"/>	<input type="checkbox"/>	<input type="checkbox"/>	
	Image replay		<input type="checkbox"/>	<input type="checkbox"/>	<input type="checkbox"/>	<input type="checkbox"/>	<input type="checkbox"/>	<input type="checkbox"/>	<input type="checkbox"/>	<input type="checkbox"/>	<input type="checkbox"/>	
Operation	Depth-of-field preview	221	<input type="checkbox"/>	<input type="checkbox"/>	<input type="checkbox"/>	<input type="checkbox"/>	<input type="checkbox"/>	<input type="checkbox"/>	<input type="checkbox"/>	<input type="checkbox"/>	<input type="checkbox"/>	<input type="checkbox"/>
	IS start		<input type="checkbox"/>	<input type="checkbox"/>	<input type="checkbox"/>	<input type="checkbox"/>	<input type="checkbox"/>	<input type="checkbox"/>	<input type="checkbox"/>	<input type="checkbox"/>	<input type="checkbox"/>	
	VF electronic level		<input type="checkbox"/>	<input type="checkbox"/>	<input type="checkbox"/>	<input type="checkbox"/>	<input type="checkbox"/>	<input type="checkbox"/>	<input type="checkbox"/>	<input type="checkbox"/>	<input type="checkbox"/>	
	MENU Menu display		<input type="checkbox"/>	<input type="checkbox"/>	<input type="checkbox"/>	<input type="checkbox"/>	<input type="checkbox"/>	<input type="checkbox"/>	<input type="checkbox"/>	<input type="checkbox"/>	<input type="checkbox"/>	
	Quick Control screen		<input type="checkbox"/>	<input type="checkbox"/>	<input type="checkbox"/>	<input type="checkbox"/>	<input type="checkbox"/>	<input type="checkbox"/>	<input type="checkbox"/>	<input type="checkbox"/>	<input type="checkbox"/>	
	OFF No function (disabled)		<input type="checkbox"/>	<input type="checkbox"/>	<input type="checkbox"/>	<input type="checkbox"/>	<input type="checkbox"/>	<input type="checkbox"/>	<input type="checkbox"/>	<input type="checkbox"/>	<input type="checkbox"/>	

* The AF stop button is provided only on super telephoto IS lenses.

● <AF> Metering and AF start

When you press the button assigned with this function, metering and AF are executed.

- *1: If you assign the **[Metering and AF start]** function to the <AF-ON> and <★> buttons and add the function to switch to the registered AF point, you can instantly switch to the registered AF point. To enable this function, press the <INFO.> button in step 3 on page 217. On the **[AF start point]** selection screen, select **[Registered AF point]**. If C.Fn III -12 **[Orientation linked AF point]** (p.214) is set to **[Select different AF points]**, you can register the AF point separately for the vertical (camera grip at top or bottom) and horizontal orientations.

Registering and using an AF point

1. Set the AF area selection mode to Single point AF, Spot AF, or AF point expansion (the AF point cannot be registered in the Zone AF and 19-point AF auto selection modes).
2. Select an AF point manually (p.88).
3. Hold down the <☒> button and press the <⦿> button. A beep will sound and the AF point will be registered. The registered AF point will be displayed as a small point <•>. If C.Fn III -12-1 has been set, register the AF point for the respective vertical and horizontal orientations of the camera.
4. When you press the <AF-ON> or <★> assigned with this function, the camera will switch to the registered AF point while in the current AF area selection mode (Single point AF, Spot AF, AF point expansion, or Zone AF). With Zone AF, focusing will switch to the zone containing the registered AF point. If you want to switch to the center zone, register the center AF point or the one on its left or right. To cancel the registered AF point, press the <☒> button and <ISO•1/2> button at the same time. Or cancel it with the [**☒**: **Clear all camera settings**] menu.

● <AF-OFF> AF stop

The AF will stop while you hold down the button assigned with this function. Convenient when you want to lock the focus during AI Servo AF.

● <AF↔> Switch to registered AF function

Set the AF area selection mode (p.87), AI Servo tracking sensitivity (p.209), AI Servo AF tracking method (p.210), and AI Servo 1st/2nd image priority (p.210). Only while you hold down the button assigned with this function, AF will be executed according to the respective setting. Convenient when you want to change the AF characteristics during AI Servo AF.

- *2: In step 3 on page 217, if you press the <INFO.> button, the AF area selection mode screen will appear. Set as desired and select **[OK]**. The next screen will then appear. After you set the four functions, the original screen will reappear.

● **<ONE SHOT / AI SERVO> ONE SHOT ↔ AI SERVO**

In One-Shot AF mode, when you hold down the button to which this function has been assigned, the camera switches to AI Servo AF mode. And in the AI Servo AF mode, the camera switches to One-Shot AF mode only while you hold down the button. Convenient when you need to keep switching between One-Shot AF and AI Servo AF for a subject which keeps moving and stopping.

● **<AF-ON> AF point direct selection**

Without pressing the **<AF-ON>** button, you can select the AF point directly with **<OK>** or **<AF-ON>**. With the **<OK>** dial, you can only select a left or right AF point.

*3: If you press the **<INFO.>** button in step 3 on page 217, you can set that pressing **<AF-ON>** straight down selects either **[Switch to center AF point]** or **[Switch to registered AF point]**.

● **<AE-L/AF-ON> Metering start**

When you press the shutter button halfway, you can execute only exposure metering.

● **<AE-L/AF-ON> AE lock**

Pressing the button assigned with this function will apply AE lock. Convenient when you want to focus and meter at different parts of the picture.

● **<FE-L> FE lock**

During flash photography, pressing the button assigned with this function will fire a preflash and record the required flash output (FE lock).

● **<Tv> Shutter speed setting in M mode**

In the **<M>** (Manual exposure) mode, you can set the shutter speed with the **<Tv>** or **<Tv>** dial.

● **<Av> Aperture setting in M mode**

In the **<M>** (Manual exposure) mode, you can set the aperture with the **<Av>** or **<Av>** dial.

● **<Q/SET> Image quality**

Press **<Q/SET>** to display the image-recording quality setting screen (p.58) on the LCD monitor.

● **<RAW/JPEG> One-touch RAW+JPEG**

When you press the **<M-Fn>** button and shoot, the RAW or JPEG image set with **[One-touch RAW+JPEG]** (p.61) will also be recorded.

- **<Picture Style> Picture Style**

Press **<SET>** to display the Picture Style selection screen (p.64) on the LCD monitor.

- **<Image replay> Image replay**

To playback images, press **<SET>**.

- **<Depth-of-field preview> Depth-of-field preview**

Pressing the depth-of-field preview button will stop down the aperture.

- **<IS start> IS start**

With the lens' IS switch set to **<ON>**, the lens' Image Stabilizer operates when you press the button.

- **<VF electronic level> VF electronic level**

Pressing the **<M-Fn>** button will display in the viewfinder a grid and an electronic level using the AF points.

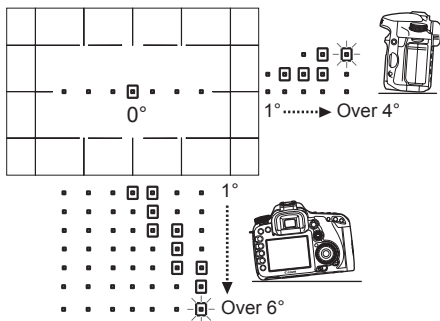

- **<MENU> Menu display**

Pressing **<SET>** will display the menu on the LCD monitor.

- **<Q> Quick Control screen**

Pressing **<SET>** will display the Quick Control screen on the LCD monitor.

- **<Off> No function (disabled)**

This is to assign no function to the button.

MENU Registering My Menu ☆

Under the My Menu tab, you can register up to six menu options and Custom Functions whose settings you change frequently.



- 1 **Select [My Menu settings].**
 - Under the [★] tab, select [My Menu settings], then press <SET>.

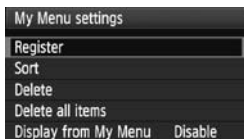

- 2 **Select [Register].**
 - Turn the <◉> dial to select [Register], then press <SET>.

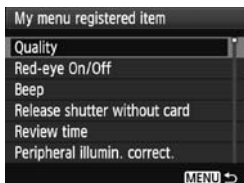

- 3 **Register the desired item.**
 - Turn the <◉> dial to select the item, then press <SET>.
 - On the confirmation dialog, select [OK] and press <SET> to register the menu item.
 - You can register up to six items in My Menu.
 - To return to the screen in step 2, press the <MENU> button.

About My Menu settings

- **Sort**

You can change the order of the registered menu items in My Menu. Select [Sort] and select the menu item whose order you want to change. Then press <SET>. With [◆] displayed, turn <◉> to change the order, then press <SET>.

- **Delete / Delete all items**

Deletes the registered menu items. [Delete] deletes one menu item at a time, and [Delete all items] deletes all menu items.

- **Display from My Menu**

When [Enable] is set, the [★] tab will be displayed first when you display the menu screen.

C1 Register Camera User Settings [☆]

Under the Mode Dial's <**C1**>, <**C2**>, and <**C3**> positions, you can register most of the current camera settings including your preferred shooting mode, menus, Custom Function settings, etc.



1 Select [Camera user setting].

- Under the [**F**] tab, select [**Camera user setting**], then press <**SET**>.

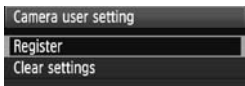

2 Select [Register].

- Turn the <**DISP**> dial to select [**Register**], then press <**SET**>.

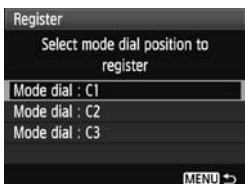

3 Register the camera user setting.

- Turn the <**DISP**> dial to select the Mode Dial position where the camera settings are to be registered, then press <**SET**>.
- On the confirmation dialog, select [**OK**] and press <**SET**>.
- ▶ The current camera settings (p.224) will be registered under the Mode Dial's C* position.

Clearing the Camera user settings











In step 2, if you select [**Clear settings**], the respective Mode Dial position will revert to the default setting effective before you registered the camera settings. The procedure is the same as step 3.







Settings Registered







● Shooting functions

Shooting mode + setting, ISO speed, AF mode, AF point, Metering mode, Drive mode, Exposure compensation amount, Flash exposure compensation amount

● Menu functions

-  Quality, Red-eye On/Off, Beep, Release shutter without card, Review time, Peripheral illumination correction, Flash control (Flash firing, Shutter sync., Flash exposure compensation, E-TTL II)
-  Exposure compensation/AEB, Auto Lighting Optimizer, White balance, Custom WB, WB SHIFT/BKT, Color space, Picture Style
-  One-touch RAW+JPEG
-  Live View shooting, AF mode, Grid display, Exposure simulation, Silent shooting, Metering timer
-  AF mode, Grid display, Movie recording size, Sound recording, Silent shooting, Metering timer (movie shooting)
-  Highlight alert, AF point display, Histogram, Slide show, Image jump w/ 
-  Auto power off, Auto rotate, File numbering
-  LCD brightness, Sensor cleaning (Auto cleaning), VF grid display
-  INFO. button display options
-  Custom Functions

-  ● The My Menu settings will not be registered.
- When the Mode Dial is set to the <>, <>, or <> position, the [ **Clear all camera settings**] and [ **Clear all Custom Func. (C.Fn)**] menus will not work.

-  ● Even when the Mode Dial is set to the <>, <>, or <> position, you can still change the drive mode and menu settings. If you want to register those changes, follow the procedure on the preceding page.
- By pressing the <INFO.> button, you can check which shooting mode is registered under the <>, <>, and <> positions (p.228).

MENU Setting Copyright Information ☆

When you set the copyright information, it will be appended to the image as Exif information.



1 Select [Copyright information].

- Under the [] tab, select [**Copyright information**], then press <SET>.



2 Select the desired option.

- Select [**Display copyright info.**] to check the copyright information currently set.
- Select [**Delete copyright information**] to delete the copyright information currently set.
- Turn the < > dial, select either [**Enter author's name**] or [**Enter copyright details**], then press <SET>.
- ▶ The text entry screen will appear.



3 Enter text.

- Refer to “Text Entry Procedure” on the next page and enter the copyright information.
- Enter up to 63 alphanumeric characters and symbols.

4 Exit the setting.

- After entering the text, press the <MENU> button to exit.

Text Entry Procedure



- Changing the entry area**
 Press the <↔> button to toggle between the top and bottom entry areas.
- Moving the cursor**
 Turn the <⦿> dial to move the cursor. You can also use <⬇> to move the cursor.

- Entering text**

In the bottom area, turn the <⦿> dial to select a character, then press <SET> to enter it. You can also tilt <⬇> up, down, left, or right to select a character and press it straight down to enter the character.

- Deleting a character**

Press the <⏮> button to delete a character.

- Exiting**

After completing the text entry, press the <MENU> button to return to the screen in step 2.

- Canceling the text entry**

To cancel the text entry, press the <INFO,> button to return to the screen in step 2.

12

Reference

This chapter provides reference information for camera features, system accessories, etc. The back of this chapter also has an index to make it easier to look up needed information.

INFO. Button Functions



When you press the <INFO.> button while the camera is ready to shoot, you can display [Displays camera settings], [Displays shooting functions] (p.225), and [Electronic level] (p.48).

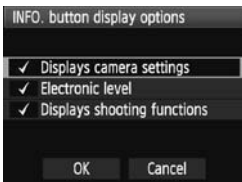

Under the [F:2] tab, the [INFO. button display options] option enables you to select what the <INFO.> button is to display when pressed.

- Turn the <◉> dial to select the desired item, then press <SET> to append a <✓> checkmark.
- After making the selection, turn the <◉> dial to select [OK], then press <SET>.

Camera Settings



C1:P	C2:P	C3:P	Shooting mode registered under the Mode Dial's C1 , C2 , and C3 positions
Color space	sRGB		(p.82)
WB SHIFT/BKT	0.0/±0		(p.73, 74)
Color temp.	5200	K	(p.72)
1 min.	X		Transfer of some images failed*
Long exp. noise reduction		OFF	(p.208)
High ISO speed noise reduct'n			(p.208)
[Possible shots] Freespace			(p.29, 59)
[300] 1.90 GB			





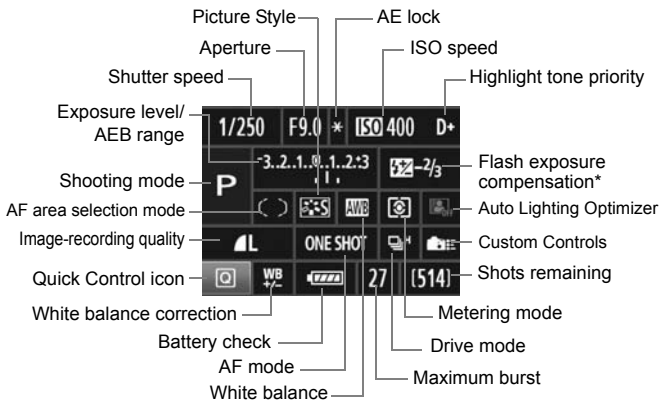





Auto power off (p.44)

* This icon is displayed only when the transfer of some images failed while using the Wireless File Transmitter WFT-E5A/B/C/D.

Shooting Settings



* If flash exposure compensation is set with an external Speedlite, the flash exposure compensation icon will change from  to .

- When you press the , the Quick Control screen appears (p.38).
- If you press the ,  ,  , or  button, the setting screen will appear on the LCD monitor and you can turn the  or  dial to set the respective function. You can also select the AF point with .



If you turn off the power while the “Shooting settings display” screen is displayed, the same screen will be displayed when you turn on the power again. To avoid this, press the  button to turn off the display on the LCD monitor, then turn off the power switch.

MENU Checking the Battery Information

You can check the battery's condition on the LCD monitor. A Battery Pack LP-E6 has a unique serial No., and you can register multiple battery packs to the camera. When you use this feature, you can check the registered battery pack's remaining capacity and operation history.



Select [Battery info.].

- Under the [] tab, select [Battery info.], then press <SET>.
- ▶ The battery info screen will appear.

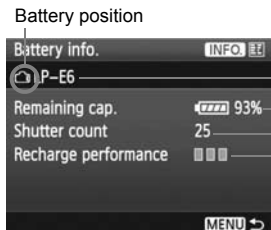

Model of the battery or household power source being used.

The battery check (p.28) displays the remaining battery capacity in 1% increments.

Shutter count or shots taken with the current battery. The number is reset when the battery is recharged.

Battery's recharge performance level is displayed in one of three levels.

- (Green): Battery's recharge performance is fine.
- (Green): Battery's recharge performance is slightly degraded.
- (Red): Purchasing a new battery is recommended.

⚠ Do not use any battery other than the Battery Pack LP-E6. Otherwise, the camera's full performance may not be attained or malfunction may result.

- If you use two LP-E6 battery packs in the Battery Grip BG-E7, battery information for the two battery packs will appear.
- When size-AA/LR6 batteries are used in the Battery Grip BG-E7, only the battery check display will be displayed.
- If for some reason, communication with the battery is not successful, the battery check display will show < > on the LCD panel and in the viewfinder. [Cannot communicate with battery] will be displayed. Just select [OK] and you can continue shooting.

Registering the Battery to the Camera

You can register up to six Battery Pack LP-E6's to the camera. To register multiple battery packs to the camera, do the procedure below for each battery pack.



1 Press the <INFO.> button.

- With the Battery info. screen displayed, press the <INFO.> button.
- ▶ The battery history screen will appear.
- ▶ If the battery has not been registered, it will be grayed out.

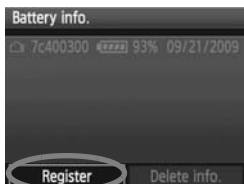

2 Select [Register].

- Turn the <◉> dial to select [Register], then press <SET>.
- ▶ The confirmation dialog will appear.



3 Select [OK].

- Turn the <◉> dial to select [OK], then press <SET>.
- ▶ The battery pack will be registered, and the battery history screen will reappear.
- ▶ The grayed out battery will now be displayed in white letters.
- Press the <MENU> button. The battery info. screen will reappear.



- Battery registration is not possible if size-AA/LR6 batteries are in the Battery Grip BG-E7 or if you use the AC Adapter Kit ACK-E6.
- If six battery packs have already been registered, [Register] cannot be selected. To delete unnecessary battery information, refer to page 233.

Labeling the Serial No. on the Battery

Affixing the serial No. onto all the registered Battery Pack LP-E6's with a label makes it convenient.

Serial No.

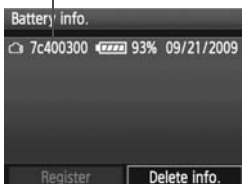

1 Write the serial No. on a label.

- Write the serial No. displayed on the battery history screen on a label about 25 mm x 15 mm / 1.0 in. x 0.6 in. in size.

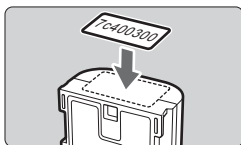

2 Take out the battery and affix the label.



- Set the power switch to <OFF>.
- Open the battery compartment cover and remove the battery.
- Affix the label as shown (side with no electrical contacts) in the illustration.
- Repeat this procedure for all of your battery packs so you can easily see the serial No.

! Do not affix the label on any part other than as shown in the illustration in step 2. Otherwise, the misplaced label might make it difficult to insert the battery or impossible to turn on the camera.

Checking the Remaining Capacity of a Registered Battery Pack

You can check the remaining capacity of any battery pack (even while not installed) and also when it was last used.

Serial No. Date last used

Battery info.		
7c400300	 93%	09/21/2009
c54406dc	 98%	09/30/2009
Register		Delete info.

Remaining capacity

Look for the serial No.

- Refer to the battery's serial No. label and look for the battery's serial No. on the battery history screen.
- ▶ You can check the respective battery pack's remaining capacity and the date when it was last used.

Deleting the Registered Battery Pack Information

1 Select [Delete battery info.].

- Follow step 2 on page 231 to select [Delete battery info.], then press <SET>.

2 Select the battery pack to be deleted.

- Turn the <◉> dial to select the battery pack to be deleted, then press <SET>.
- ▶ <✓> will appear.
- To delete another battery pack, repeat this procedure.

3 Press the <🗑️> button.

- ▶ The confirmation dialog will appear.

4 Select [OK].

- Turn the <◉> dial to select [OK], then press <SET>.
- ▶ The battery pack information will be deleted, and the screen in step 1 will reappear.

Using a Household Power Outlet

With the AC Adapter Kit ACK-E6 (sold separately), you can connect the camera to a household power outlet and not worry about the battery level.

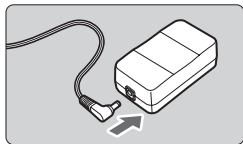

1 Connect the DC Coupler's plug.

- Connect the DC Coupler's plug to the AC Adapter's socket.

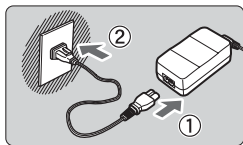

2 Connect the power cord.

- Connect the power cord as shown in the illustration.
- After using the camera, unplug the power plug from the power outlet.

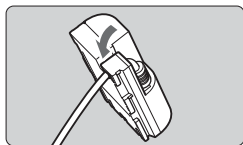

3 Place the cord in the groove.

- Insert the DC Coupler's cord carefully without damaging the cord.

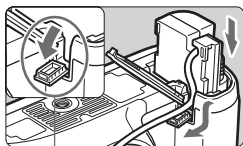

DC Coupler cord hole

4 Insert the DC Coupler.

- Open the battery compartment cover and open the DC Coupler cord notch cover.
- Insert the DC Coupler securely until it locks and put the cord through the notch.
- Close the cover.

! Do not connect or disconnect the power cord while the camera's power switch is set to <ON>.

Replacing the Date/Time Battery

The date/time (back-up) battery maintains the camera's date and time. Its service life is about 5 years. If you turn on the power and the date/time is reset, replace the back-up battery with a new CR1616 lithium battery as described below.

The date/time setting will also be reset, so be sure to set the correct date/time (p.42).

1 Set the power switch to <OFF>.

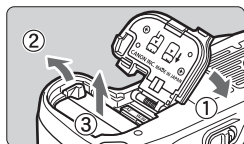

2 Remove the battery.

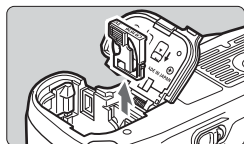

3 Take off the battery holder.

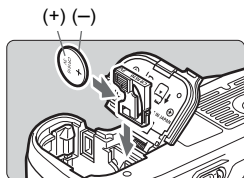

4 Replace the battery.

- Make sure the battery is in the proper + - orientation.

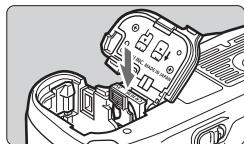

5 Insert the battery holder.

- Then load the battery and close the cover.

 For the date/time battery, be sure to use a CR1616 lithium battery.

Function Availability Table

● : Set automatically ○ : User selectable □ : Not selectable

Mode Dial		<input type="checkbox"/>	<input type="checkbox"/> CA	P	Tv	Av	M	B
Quality	JPEG	○	○	○	○	○	○	○
	RAW	○	○	○	○	○	○	○
	RAW+JPEG	○	○	○	○	○	○	○
ISO speed	Auto	●	●	○	○	○	○	○
	Manual	□	□	○	○	○	○	○
Picture Style	Standard	●	○	○	○	○	○	○
	Portrait	□	○	○	○	○	○	○
	Landscape	□	○	○	○	○	○	○
	Neutral	□	□	○	○	○	○	○
	Faithful	□	□	○	○	○	○	○
	Monochrome	□	○	○	○	○	○	○
	User Defined	□	□	○	○	○	○	○
White balance	Auto WB	●	●	○	○	○	○	○
	Preset WB	□	□	○	○	○	○	○
	Custom WB	□	□	○	○	○	○	○
	Color temperature setting	□	□	○	○	○	○	○
	WB correction	□	□	○	○	○	○	○
	WB bracketing	□	□	○	○	○	○	○
Color space	sRGB	●	●	○	○	○	○	○
	Adobe RGB	□	□	○	○	○	○	○
Auto Lighting Optimizer		●	●	○	○	○	○	○
Peripheral illumination correction		○	○	○	○	○	○	○
Long exposure noise reduction		□	□	○	○	○	○	○
High ISO speed noise reduction		●	●	○	○	○	○	○
Highlight tone priority		□	□	○	○	○	○	○

●: Set automatically ○: User selectable □: Not selectable

Mode Dial		□	CA	P	Tv	Av	M	B	
AF	One-Shot	□	□	○	○	○	○	○	
	AI Servo	□	□	○	○	○	○	○	
	AI Focus	●	●	○	○	○	○	○	
	AF point selection	Auto	●	●	○	○	○	○	○
		Manual	□	□	○	○	○	○	○
AF-assist beam	●	●	○	○	○	○	○		
Metering mode	Evaluative	●	●	○	○	○	○	○	
	Partial	□	□	○	○	○	○	○	
	Spot	□	□	○	○	○	○	○	
	Center-weighted average	□	□	○	○	○	○	○	
Exposure	Program shift	□	○*1	○	□	□	□	□	
	Exposure compensation	□	○*2	○	○	○	□	□	
	AEB	□	□	○	○	○	○	□	
	AE lock	□	□	○	○	○	□	□	
	Depth-of-field preview	□	□	○	○	○	○	○	
Drive	Single shooting	●	○	○	○	○	○	○	
	High-speed continuous shooting	□	□	○	○	○	○	○	
	Low-speed continuous shooting	□	○	○	○	○	○	○	
	10 sec. self-timer/ Remote control	○	○	○	○	○	○	○	
	2 sec. self-timer/ Remote control	□	□	○	○	○	○	○	
Built-in flash	Automatic firing	●	○	□	□	□	□	□	
	Manual firing	□	○	○	○	○	○	○	
	Flash off	□	○	□	□	□	□	□	
	Red-eye reduction	○	○	○	○	○	○	○	
	FE lock	□	□	○	○	○	○	○	
	Flash exposure compensation	□	○*2	○	○	○	○	○	
Live View shooting		○	○	○	○	○	○	○	
Movie shooting		○	○	○	○	○	○	○	

*1: Refers to “(2) Blurring/sharpening the background” function on page 54.

*2: Refers to “(3) Adjusting the picture brightness” function on page 54.

Menu Settings

Shooting 1 (Red)

Page

Quality	L / L / M / M / S / S	58
	RAW / M RAW / S RAW	
Red-eye On/Off	Off / On	112
Beep	On / Off	—
Release shutter without card	Enable / Disable	29
Review time	Off / 2 sec. / 4 sec. / 8 sec. / Hold	56
Peripheral illumination correction	Enable / Disable	76
Flash control	Flash firing / Built-in flash function setting / External flash function setting / External flash C.Fn setting / Clear external flash C.Fn setting	115

Shooting 2 (Red)

Exposure compensation/AEB	1/3-stop increments, ±5 stops (AEB ±3 stops)	105
Auto Lighting Optimizer	Disable / Low / Standard / Strong	75
White balance	AWB / / / / / / / / / (2500 - 10000)	70
Custom WB	Manual setting of white balance	71
WB SHIFT/BKT	WB correction: White balance correction	73
	WB-BKT: White balance bracketing	74
Color space	sRGB / Adobe RGB	82
Picture Style	Standard / Portrait / Landscape / Neutral / Faithful / Monochrome / User Def. 1, 2, 3	64-69



The shaded menu items are not displayed in fully-automatic modes (/).

📷 Shooting 3 (Red)

Page

Dust Delete Data	Obtains data to be used to erase dust spots	185
One-touch RAW+JPEG	Also capture RAW or JPEG when necessary	61

📷 Shooting 4 (Red)

Live View shooting	Enable / Disable	136
AF mode	Live mode /  Live mode / Quick mode	138
Grid display	Off / Grid 1  / Grid 2 	136
Exposure simulation	Enable / Disable	136
Silent shooting	Mode 1 / Mode 2 / Disable	137
Metering timer	4 sec. / 16 sec. / 30 sec. / 1 min. / 10 min. / 30 min.	137

* For movie shooting, see page 242.

🖼 Playback 1 (Blue)



Protect images	Erase-protect images	178
Rotate	Rotate vertical images	168
Erase images	Erase images	179
Print order	Specifies images to be printed (DPOF)	199
External media backup	Displayed when external media is used via WFT-E5A/B/C/D (sold separately)	—

🖼 Playback 2 (Blue)

Highlight alert	Disable / Enable	163
AF point display	Disable / Enable	163
Histogram	Brightness / RGB	164
Slide show	Select the images and set the Play time and repeat settings for automatic playback	174
Image jump w/ 	1 image / 10 images / 100 images / Date / Folder / Movies / Stills	166

☛ Set-up 1 (Yellow)

Page



Auto power off	1 min. / 2 min. / 4 min. / 8 min. / 15 min. / 30 min. / Off	44
Auto rotate	On   / On  / Off	182
Format	Initialize and erase data in the card	43
File numbering	Continuous / Auto reset / Manual reset	80
Select folder	Create and select a folder	78
WFT settings	Displayed when WFT-E5A/B/C/D (sold separately) is attached	—
Recording function+media select	Displayed when external media is used via WFT-E5A/B/C/D (sold separately)	—

☛ Set-up 2 (Yellow)

LCD brightness	Auto: Adjustable to one of three brightness levels Manual: Adjustable to one of seven brightness levels	181
Date/Time	Set the date (year, month, day) and time (hour, min., sec.)	42
Language 	Language selectable	42
Video system	NTSC / PAL	176
Sensor cleaning	Auto cleaning: Enable / Disable	184
	Clean now	
	Clean manually	187
VF grid display	Disable / Enable	47

Set-up 3 (Yellow)

Page

Battery info.	Type, Remaining capacity, Shutter count, Recharge performance, Battery registration, Battery history	230
INFO. button display options	Displays camera settings / Electronic level / Displays shooting functions	228
Camera user setting	Register current camera settings to the Mode Dial's  ,  , or  position	223
Copyright information	Display copyright information / Enter author's name / Enter copyright details / Delete copyright information	225
Clear all camera settings	Resets the camera to the default settings	45
Firmware Ver.	For updating the firmware	—

Custom Functions (Orange)

C.Fn I : Exposure	Customize camera functions as desired	206
C.Fn II : Image		208
C.Fn III : Autofocus/ Drive		209
C.Fn IV : Operation/ Others		215
Clear all Custom Functions (C.Fn)	Clears all Custom Function settings	204











My Menu (Green)

My Menu settings	Register frequently-used menu items and Custom Functions	222
-------------------------	--	-----

Movie Shooting Menu

Movie (Red)

Page

AF mode	Live mode /  Live mode / Quick mode	156
Grid display	Off / Grid 1  / Grid 2 	156
Movie recording size	1920x1080 ( /  / ) / 1280x720 ( / ) / 640x480 ( / )	156
Sound recording	On / Off	157
Silent shooting	Mode 1 / Mode 2 / Disable	157
Metering timer	4 sec. / 16 sec. / 30 sec. / 1 min. / 10 min. / 30 min.	157

Troubleshooting Guide

If a problem occurs, first refer to this Troubleshooting Guide. If this Troubleshooting Guide does not resolve the problem, contact your dealer or nearest Canon Service Center.

Power-Related Problems

The battery pack does not recharge.

- If the battery's remaining capacity (p.230) is 94% or higher, the battery will not be recharged.
- Do not recharge any battery pack other than genuine Canon Battery Pack LP-E6.

The charger's lamp blinks at high speed.

- If there is a problem with the battery charger or battery pack or if communication with the battery pack (non-Canon battery packs) is not possible, the protective circuit will terminate the charging and the orange lamp will blink quickly at a regular interval. If there is a problem with the battery charger or battery pack, unplug the charger's power plug from the power outlet. Detach and reattach the battery pack to the charger. Wait 2 to 3 minutes, then reconnect the power plug to the power outlet. If the problem persists, contact your dealer or nearest Canon Service Center.

The charger's lamp does not blink.

- If the internal temperature of the battery pack attached to the charger is high, the charger will not charge the battery for safety reasons (lamp off). During the charging, if the battery's temperature becomes high for any reason, the charging will stop automatically (lamp blinks). When the battery temperature goes down, the charging will resume automatically.

The camera does not operate even when the power switch is set to <ON>.

- The battery is not properly installed in the camera (p.26).
- Recharge the battery (p.24).
- Make sure the battery compartment cover is closed (p.26).
- Make sure the card slot cover is closed (p.29).

The access lamp still blinks even when the power switch is set to <OFF>.

- If the power is cut off while an image is being recorded to the card, the access lamp will still continue to light/blink for a few seconds. When the image recording is completed, the power will turn off automatically.

The battery becomes exhausted quickly.

- Use a fully-charged battery (p.24).
- The battery performance might have degraded. See the [ **Battery info.**] menu to check the battery's performance level (p.230). If the battery performance is poor, replace the battery pack with a new one.
- If you keep displaying the Quick Control screen (p.38) or shooting Live View shooting or movie shooting (p.131, 149) for a prolonged period, the number of possible shots will decrease.

The camera turns off by itself.

- Auto power off is in effect. If you do not want auto power off to take effect, set [ **Auto power off**] to [Off].

Shooting-Related Problems

No images can be shot or recorded.

- The card is not properly inserted (p.29).
- If the card is full, replace the card or delete unnecessary images to make room (p.29, 179).
- If you try to focus in One-Shot AF mode while the focus confirmation light <●> in the viewfinder blinks, a picture cannot be taken. Press the shutter button halfway again to focus, or focus manually (p.35, 92).

The viewfinder is dark.

- Install a recharged battery pack in the camera (p.26).

The image is out of focus.

- Set the lens focus mode switch to **<AF>** (p.31).
- To prevent camera shake, hold the camera still and press the shutter button gently (p.34, 35).
- If the lens has an Image Stabilizer, set the IS switch to **<ON>**.

The card cannot be used.

- If a card error message is displayed, see page 30 or 249.

The maximum burst during continuous shooting is lower.

- Set [**C.Fn II -2: High ISO speed noise reduction**] to one of the following settings: [**Standard/Low/Disable**]. If it is set to [**Strong**], the maximum burst during continuous shooting will decrease (p.208).
- If you shoot a subject which has fine detail (field of grass, etc.), the file size will be larger and the actual maximum burst will be lower than the number mentioned on page 59.

ISO 100 cannot be set.

- If [**C.Fn II -3: Highlight tone priority**] is set to [**Enable**], ISO 100 cannot be set. If [**Disable**] is set, ISO 100 can be set (p.209).

When I use the **<Av> mode with flash, the shutter speed becomes slow.**

- If you shoot at night when the background is dark, the shutter speed becomes slow automatically (slow-sync shooting) so that both the subject and background are properly exposed. If you do not want a slow shutter speed to be set, set [**C.Fn I -7: Flash sync. speed in Av mode**] to 1 or 2 (p.207).

The built-in flash does not fire.

- If you shoot continuously with the built-in flash at short intervals, the flash might stop operating to protect the flash unit.

The external flash does not fire.

- Make sure the external flash (or PC sync cord) is securely attached to the camera.
- If you use a non-Canon flash with Live View shooting, set the [ Silent shoot.] menu to [Disable] (p.137).

The camera makes a noise when it is shaken.

- The built-in flash's pop-up mechanism moves slightly. This is normal.

The shutter makes two shooting sounds during Live View shooting.

- If you use flash, the shutter will make two sounds each time you shoot (p.133).

Live View shooting is not possible.

- For Live View shooting, use a memory card (a hard disk-type card is not recommended). A hard disk-type card requires a lower temperature range for operation than normal memory cards. If the temperature gets too high, the Live View shooting may stop temporarily to prevent damage to the card's hard disk. When the camera's internal temperature decreases, you can resume Live View shooting (p.146).

The camera button/dial's function has changed.

- Check the setting with [ C.Fn IV -1: Custom Controls] (p.215).

The movie shooting terminates by itself.

- If the card's writing speed is slow, movie shooting may stop automatically. Use a card with a read/write speed of at least 8 MB per sec. To find out the card's read/write speed, see the card manufacturer's Web site.
- If the movie file size reaches 4 GB or if the movie recording time reaches 29 min. 59 sec., movie shooting will stop automatically.

When the movie is played, camera operation noise can be heard.

- If you operate the camera's dial or lens during movie shooting, the respective operation noise will also be recorded. Use an external microphone (commercially available) (p.158).

Display & Operation Problems**In the viewfinder, the AF point display speed is slow.**

- In low temperatures, the display speed of the AF points may become slower due to the AF point display device's (liquid crystal) characteristics. The display speed will return to normal at room temperature.

The LCD monitor does not display a clear image.

- If the LCD monitor is dirty, use a soft cloth to clean it.
- In low or high temperatures, the LCD monitor display may seem slow or might look black. It will return to normal at room temperature.

The menu screen shows few tabs and options.

- In fully-automatic modes (□/CA), some tabs and options are not displayed. Set the shooting mode to **P/Tv/Av/M/B** (p.40).

Part of the image blinks in black.

- The [☐] **Highlight alert** menu option is set to [Enable] (p.163).

A red box is displayed on the image.

- The [☐] **AF point disp.** menu option is set to [Enable] (p.163).

The file name's first character is an underscore (“_MG_”).

- Set the color space to sRGB. If Adobe RGB is set, the first character will be an underscore (p.82).

The file numbering does not start from 0001.

- If you use a card which already has images recorded, the file numbering might start from the last image in the card (p.80).

The shooting date and time displayed is incorrect.

- The correct date and time has not been set (p.42).

No image appears on the TV screen.

- Make sure the AV cable or HDMI cable's plug is connected all the way in (p.176, 177).
- Set the video OUT format (NTSC/PAL) to the same video format as the TV (p.240).
- Use the AV cable that came with the camera (p.176).

Printing-Related Problems

There are fewer printing effects than listed in the instruction manual.

- What the screen displays may differ depending on the printer. This instruction manual lists all the printing effects available (p.194).

Error Codes

Error No. If there is a problem with the camera, an error message will appear. Follow the on-screen instructions.



Countermeasures

No.	Error Message & Solution
01	Communications between the camera and lens is faulty. Clean the lens contacts.
	→ Clean the electrical contacts on the camera and lens and use a Canon lens. (p.13, 16)
02	Card cannot be accessed. Reinsert/change card or format card with camera.
	→ Remove and install the card again, replace the card, or format the card (p.29, 43).
04	Cannot save images because card is full. Replace card.
	→ Replace the card, erase unnecessary images, or format the card (p.29, 179, 43).
05	The built-in flash could not be raised. Turn the camera off and on again.
	→ Operate the power switch (p.27).
06	Sensor cleaning is not possible. Turn the camera off and on again.
	→ Operate the power switch (p.27).
10, 20, 30, 40, 50, 60, 70, 80	Shooting is not possible due to an error. Turn the camera off and on again or re-install the battery.
	→ Operate the power switch, remove and install the battery pack again, or use a Canon lens (p.27, 26).

* If the error still persists, write down the error No. and contact your nearest Canon Service Center.

System Map

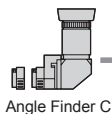
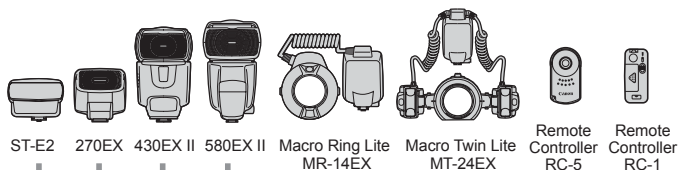

Bundled Accessories

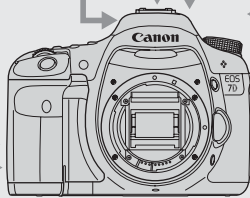
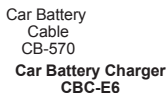
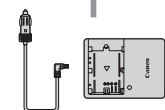
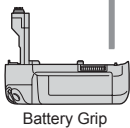
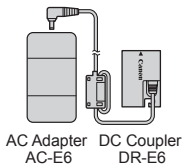
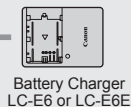
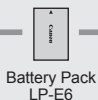
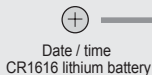

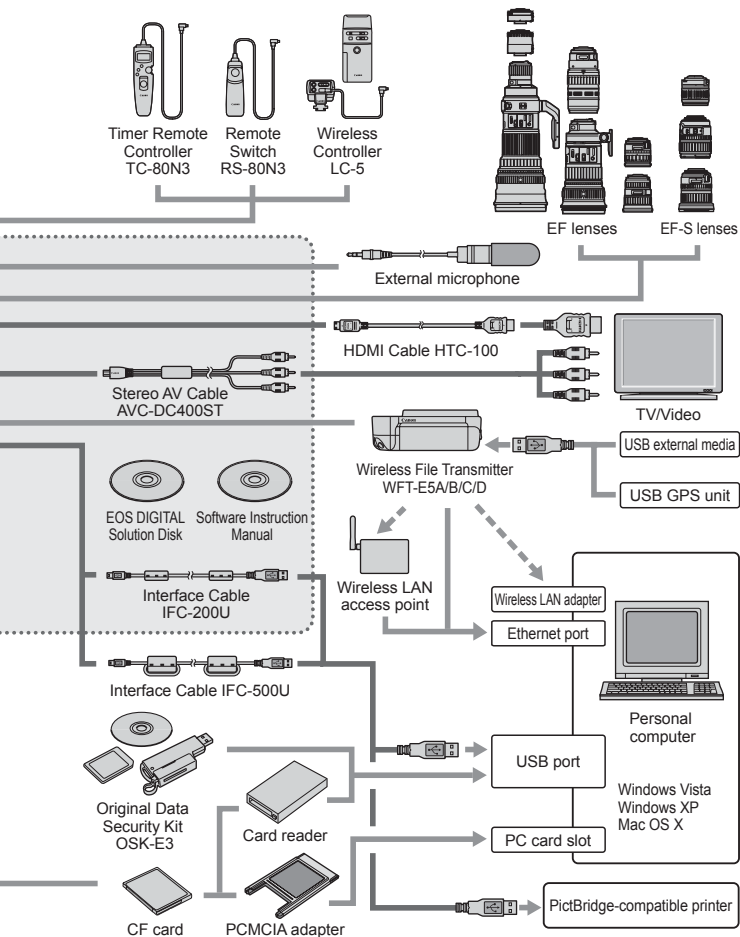

Specifications

• Type

Type:	Digital, single-lens reflex, AF/AE camera with built-in flash
Recording media:	Type I or II CF card, UDMA-compatible
Image sensor size:	22.3 x 14.9 mm
Compatible lenses:	Canon EF lenses (including EF-S lenses) (35mm-equivalent focal length is approx. 1.6 times the lens focal length)
Lens mount:	Canon EF mount

• Image Sensor

Type:	CMOS sensor
Effective pixels:	Approx. 18.00 megapixels
Aspect ratio:	3:2
Dust delete feature:	Auto, Manual, Dust Delete Data appending

• Recording System

Recording format:	Design rule for Camera File System 2.0
Image type:	JPEG, RAW (14-bit Canon original) RAW+JPEG simultaneous recording possible
Recorded pixels:	Large : Approx. 17.90 megapixels (5184 x 3456) Medium : Approx. 8.00 megapixels (3456 x 2304) Small : Approx. 4.50 megapixels (2592 x 1728) RAW : Approx. 17.90 megapixels (5184 x 3456) M-RAW : Approx. 10.10 megapixels (3888 x 2592) S-RAW : Approx. 4.50 megapixels (2592 x 1728)
Create/select a folder:	Possible

• Image Processing

Picture Style:	Standard, Portrait, Landscape, Neutral, Faithful, Monochrome, User Def. 1 - 3
White balance:	Auto, Preset (Daylight, Shade, Cloudy, Tungsten light, White fluorescent light, Flash), Custom, Color temperature setting (2500-10000K), white balance correction, and white balance bracketing possible * Color temperature information transmission enabled
Noise reduction:	Applicable to long exposures and high ISO speed shots
Automatic image brightness correction:	Auto Lighting Optimizer
Highlight tone priority:	Provided
Lens peripheral illumination correction:	Provided

• Viewfinder

Type:	Eye-level pentaprism
Coverage:	Vertical/Horizontal approx. 100%
Magnification:	Approx. 1.0x (-1 m ⁻¹ with 50mm lens at infinity)
Eye point:	Approx. 22 mm (From eyepiece lens center at -1m ⁻¹)
Built-in dioptic adjustment:	-3.0 - +1.0 m ⁻¹ (dpt)
Focusing screen:	Fixed
Composition aids:	Grid and electronic level
Mirror:	Quick-return type
Depth-of-field preview:	Provided

• Autofocus

Type:	TTL secondary image-registration, phase detection
AF points:	19 (All cross-type)
Metering range:	EV -0.5 - 18 (at 23°C/73°F, ISO 100)
Focus modes:	One-Shot AF, AI Servo AF, AI Focus AF, Manual focusing (MF)
AF area selection modes:	Single point AF, Spot AF, AF point expansion, Zone AF, 19-point AF auto selection
AF-assist beam:	Small series of flashes fired by built-in flash
AF fine adjustment:	Enabled with AF Microadjustment

• Exposure Control

Metering modes:	63-zone TTL full-aperture metering <ul style="list-style-type: none"> • Evaluative metering (linkable to any AF point) • Partial metering (approx. 9.4% of viewfinder at center) • Spot metering (approx. 2.3% of viewfinder at center) • Center-weighted average metering
Metering range:	EV 1 - 20 (at 23°C/73°F with EF50mm f/1.4 USM lens, ISO 100)
Exposure control:	Program AE (Full Auto, Creative Auto, Program), shutter-priority AE, aperture-priority AE, manual exposure, bulb exposure
ISO speed: (Recommended exposure index)	Auto, Creative Auto: Automatically set within ISO 100 - 3200 P, Tv, Av, M, B: ISO 100 - 6400 (in 1/3-stop increments), Auto, or ISO expansion to ISO 12800
Exposure compensation:	Manual and AEB (Settable in combination with manual exposure compensation) Settable amount: ±5 stops in 1/3- or 1/2-stop increments (AEB ±3 stops)
AE lock:	Auto: With One-Shot AF and evaluative metering, AE lock is applied when focus is achieved Manual: By AE lock button

• Shutter

Type:	Electronically-controlled, focal-plane shutter
Shutter speeds:	1/8000 sec. to 1/60 sec. (Full Auto mode), X-sync at 1/250 sec. 1/8000 sec. to 30 sec., bulb (Total shutter speed range. Available range varies by shooting mode.)

• Flash

Built-in flash:	Retractable, auto pop-up flash Guide No.: 12/39 (ISO 100, in meters/feet) Flash coverage: 15mm lens angle of view Recycling time approx. 3 sec. Wireless master unit function provided
External flash:	EX-series Speedlite (Functions settable with the camera)
Flash metering:	E-TTL II autoflash
Flash exposure compensation:	±3 stops in 1/3- or 1/2-stop increments
FE lock:	Provided
PC terminal:	Provided

• Drive System

Drive modes:	Single, High-speed continuous, Low-speed continuous, 10-sec. self-timer/remote control, 2-sec. self-timer/remote control
Continuous shooting speed:	Max. 8 shots per sec.
Max. burst:	JPEG Large/Fine: Approx. 94 (126) shots RAW: Approx. 15 (15) shots RAW+JPEG Large/Fine: Approx. 6 (6) shots * Figures are based on Canon's testing standards (ISO 100 and Standard Picture Style) and a 4GB card. * Figures in parentheses apply to an Ultra DMA (UDMA) 4GB card based on Canon's testing standards.

• Live View Shooting

Focusing:	Live mode, Face detection Live mode (Contrast detection) Quick mode (Phase-difference detection) Manual focusing (5x/10x magnification possible)
Metering modes:	Evaluative metering with the image sensor
Metering range:	EV 1 - 20 (at 23°C/73°F with EF50mm f/1.4 USM lens, ISO 100)
Silent shooting:	Provided (Mode 1 and 2)
Grid display:	Two types

• Movie Shooting

Movie compression:	MPEG-4 AVC Variable (average) bit rate
Audio recording format:	Linear PCM
File type:	MOV
Recording size and frame rate:	1920x1080 (Full HD): 30p/25p/24p 1280x720 (HD) : 60p/50p 640x480 (SD) : 60p/50p * 30p: 29.97 fps, 25p: 25.0 fps, 24p: 23.976 fps, 60p: 59.94 fps, 50p: 50.0 fps
File size:	1920x1080 (30p/25p/24p): Approx. 330 MB/min. 1280x720 (60p/50p) : Approx. 330 MB/min. 640x480 (60p/50p) : Approx. 165 MB/min.
Focusing:	Same as focusing with Live View shooting
Metering modes:	Evaluative and center-weighted average metering with the image sensor * Automatically set by the AF mode
Metering range:	EV 0 - 20 (at 23°C/73°F with EF50mm f/1.4 USM lens, ISO 100)
Exposure control:	Program AE (exposure compensation possible) for movies and manual exposure
ISO speed:	Automatically set within ISO 100 - 6400, expandable to 12800 With manual exposure, ISO 100 - 6400 set automatically/manually
Sound recording:	Built-in monaural microphone External stereo microphone terminal provided
Grid display:	Two types

• LCD Monitor

Type:	TFT color liquid-crystal monitor
Monitor size and dots:	3-in. with approx. 920,000 dots (VGA)
Coverage:	Approx. 100%
Brightness adjustment:	Auto, manual
Electronic level:	Provided
Interface language:	25

• Image Playback

Image display formats:	Single, Single + Info (Image-recording quality, shooting information, histogram), 4-image index, 9-image index, image rotate possible
Zoom magnification:	Approx. 1.5x - 10x

Image browsing methods: Single image, jump by 10 or 100 images, by shooting date, by folder, by movie, by stills

Highlight alert: Overexposed highlights blink

Slide show: All images, by folder, by date, movies, or stills

Movie playback: Enabled (LCD monitor, video/audio OUT, HDMI OUT)
Built-in speaker

• Direct Printing

Compatible printers: PictBridge-compatible printers

Printable images: JPEG and RAW images

Print ordering: DPOF Version 1.1 compatible

• Custom Functions

Custom Functions: 27

Camera user settings: Register under Mode Dial's C1, C2, and C3 positions

My Menu registration: Provided

Copyright information: Entry and inclusion enabled

• Interface

Audio/video OUT/

Digital terminal: Analog video (Compatible with NTSC/PAL)/stereo audio output
For personal computer communication and direct printing (Hi-Speed USB equivalent)

HDMI mini OUT terminal: Type C (Auto switching of resolution)

External microphone

IN terminal: 3.5mm dia. stereo mini-jack

Remote control terminal: Compatible with N3-type remote control

Wireless remote control: Compatible with Remote Controller RC-1/RC-5

Extension system terminal: For connection to Wireless File Transmitter WFT-E5A/B/C/D

• Power Source

Battery: Battery Pack LP-E6 (Quantity 1)
* AC power can be supplied via AC Adapter Kit ACK-E6
* With Battery Grip BG-E7 attached, size-AA/LR6 batteries can be used

Battery information: Remaining capacity, Shutter count, and Recharge performance displayed

Battery life: With viewfinder shooting:
(Based on CIPA testing standards) Approx. 800 shots at 23°C/73°F, approx. 750 shots at 0°C/32°F
With Live View shooting:
Approx. 220 shots at 23°C/73°F, approx. 210 shots at 0°C/32°F

Maximum movie

shooting time: Approx. 1 hr. 20 min. at 23°C/73°F
 Approx. 1 hr. 10 min. at 0°C/32°F
 (With fully-charged Battery Pack LP-E6)

• Dimensions and Weight

Dimensions (W x H x D): 148.2 x 110.7 x 73.5 mm / 5.8 x 4.4 x 2.9 in.
Weight: Approx. 820 g / 28.9 oz. (body only)

• Operation Environment

Working temperature range: 0°C - 40°C / 32°F - 104°F
Working humidity: 85% or less

• Battery Pack LP-E6

Type: Rechargeable lithium-ion battery
Rated voltage: 7.2 V DC
Battery capacity: 1800 mAh
Dimensions (W x H x D): 38.4 x 21 x 56.8 mm / 1.5 x 0.8 x 2.2 in.
Weight: Approx. 80 g / 2.8 oz.

• Battery Charger LC-E6

Compatible battery: Battery Pack LP-E6
Recharging time: Approx. 2 hr. 30 min.
Rated input: 100 - 240 V AC (50/60 Hz)
Rated output: 8.4 V DC/1.2A
Working temperature range: 5°C - 40°C / 41°F - 104°F
Working humidity: 85% or less
Dimensions (W x H x D): 69 x 33 x 93 mm / 2.7 x 1.3 x 3.7 in.
Weight: Approx. 130 g / 4.6 oz.

• Battery Charger LC-E6E

Compatible battery: Battery Pack LP-E6
Power cord length: Approx. 1 m / 3.3 ft.
Recharging time: Approx. 2 hours 30 min.
Rated input: 100 - 240 V AC (50/60 Hz)
Rated output: 8.4 V DC/1.2A
Working temperature range: 5°C - 40°C / 41°F - 104°F
Working humidity: 85% or less
Dimensions (W x H x D): 69 x 33 x 93 mm / 2.7 x 1.3 x 3.7 in.
Weight: Approx. 125 g / 4.4 oz. (excluding power cord)

• **EF-S15-85mm f/3.5-5.6 IS USM**

Angle of view:	Diagonal extent: 84°30' - 18°25' Horizontal extent: 74°10' - 15°25' Vertical extent: 53°30' - 10°25'
Lens construction:	17 elements in 12 groups
Minimum aperture:	f/22 - 36
Closest focusing distance:	0.35 m / 1.15 ft. (From image sensor plane)
Max. magnification:	0.21x (at 85mm)
Field of view:	255 x 395 - 72 x 108 mm / 10.0 x 15.6 - 2.8 x 4.3 in. (at 0.35 m / 1.15 ft.)
Image Stabilizer:	Lens shift type
Filter size:	72 mm
Lens cap:	E-72U
Max. diameter x length:	81.6 x 87.5 mm / 3.2 x 3.4 in.
Weight:	Approx. 575 g / 20.3 oz.
Hood:	EW-78E (sold separately)
Case:	LP1116 (sold separately)

• **EF-S18-135mm f/3.5-5.6 IS**

Angle of view:	Diagonal extent: 74°20' - 11°30' Horizontal extent: 64°30' - 9°30' Vertical extent: 45°30' - 6°20'
Lens construction:	16 elements in 12 groups
Minimum aperture:	f/22 - 36
Closest focusing distance:	0.45 m / 1.48 ft. (From image sensor plane) (at 135mm) * The minimum focusing distance varies depending on the lens focal length.
Max. magnification:	0.21x (at 135mm)
Field of view:	327 x 503 mm / 12.9 x 19.8 in. (at 0.49 m / 1.61 ft.) - 75 x 112 mm / 3.0 x 4.4 in. (at 0.45 m / 1.48 ft.)
Image Stabilizer:	Lens shift type
Filter size:	67 mm
Lens cap:	E-67U
Max. diameter x length:	75.4 x 101 mm / 3.0 x 4.0 in.
Weight:	Approx. 455 g / 16.0 oz.
Hood:	EW-73B (sold separately)
Case:	LP1116 (sold separately)

• EF28-135mm f/3.5-5.6 IS USM

Angle of view:	Diagonal extent: 75° - 18° Horizontal extent: 65° - 15° Vertical extent: 46° - 10°
Lens construction:	16 elements in 12 groups
Minimum aperture:	f/22 - 36
Closest focusing distance:	0.5 m / 1.64 ft. (From image sensor plane)
Max. magnification:	0.19x (at 135mm)
Field of view:	551 x 355 - 188 x 125 mm / 21.7 x 14.0 - 7.4 x 4.9 in. (at 0.5 m / 1.64 ft.)
Image Stabilizer:	Lens shift type
Filter size:	72 mm
Lens cap:	E-72U
Max. diameter x length:	78.4 x 96.8 mm / 3.1 x 3.8 in.
Weight:	Approx. 500 g / 17.6 oz.
Hood:	EW-78B II (sold separately)
Case:	LP1116 (sold separately)

- All specifications above are based on Canon's testing standards.
- The camera's specifications and exterior are subject to change without notice.
- If a problem occurs with a non-Canon lens attached to the camera, consult the respective lens maker.

Trademarks

- Adobe is a trademark of Adobe Systems Incorporated.
- CompactFlash is a trademark of SanDisk Corporation.
- Windows is a trademark or registered trademark of Microsoft Corporation in the United States and other countries.
- Macintosh and Mac OS is a trademark or registered trademark of Apple Inc. in the United States and other countries.
- HDMI, HDMI logo, and High-Definition Multimedia Interface are a trademark or registered trademark of HDMI Licensing LLC.
- All other corporate and product names and trademarks mentioned in this manual are the property of their respective owners.

* This digital camera supports Design rule for Camera File System 2.0 and Exif 2.21 (also called "Exif Print"). Exif Print is a standard that enhances compatibility between digital cameras and printers. By connecting the camera to an Exif Print-compliant printer, the shooting information is incorporated to optimize the print output.

About MPEG-4 Licensing

"This product is licensed under AT&T patents for the MPEG-4 standard and may be used for encoding MPEG-4 compliant video and/or decoding MPEG-4 compliant video that was encoded only (1) for a personal and non-commercial purpose or (2) by a video provider licensed under the AT&T patents to provide MPEG-4 compliant video. No license is granted or implied for any other use for MPEG-4 standard."

* Notice displayed in English as required.

Use of genuine Canon accessories is recommended

This product is designed to achieve excellent performance when used with genuine Canon accessories. Canon shall not be liable for any damage to this product and/or accidents such as fire, etc., caused by the malfunction of non-genuine Canon accessories (e.g., a leakage and/or explosion of a battery pack). Please note that this warranty does not apply to repairs arising out of the malfunction of non-genuine Canon accessories, although you may request such repairs on a chargeable basis.

-  The charger cannot charge any battery other than Battery Pack LP-E6.
- Battery Pack LP-E6 is dedicated to Canon products only. Using it with an incompatible battery charger or product may result in malfunction or accidents for which Canon cannot be held liable.

Safety Warnings

Follow these safeguards and use the equipment properly to prevent injury, death, and material damage.

Preventing Serious Injury or Death

- To prevent fire, excessive heat, chemical leakage, and explosions, follow the safeguards below:
 - Do not use any batteries, power sources, and accessories not specified in this booklet. Do not use any home-made or modified batteries.
 - Do not short-circuit, disassemble, or modify the battery pack or back-up battery. Do not apply heat or apply solder to the battery pack or back-up battery. Do not expose the battery pack or back-up battery to fire or water. And do not subject the battery pack or back-up battery to strong physical shock.
 - Do not install the battery pack or back-up battery in reversed polarity (+ -). Do not mix new and old or different types of batteries.
 - Do not recharge the battery pack outside the allowable ambient temperature range of 0°C - 40°C (32°F - 104°F). Also, do not exceed the recharging time.
 - Do not insert any foreign metallic objects into the electrical contacts of the camera, accessories, connecting cables, etc.
- Keep the back-up battery away from children. If a child swallows the battery, consult a physician immediately. (Battery chemicals may harm the stomach and intestines.)
- When disposing of a battery pack or back-up battery, insulate the electrical contacts with tape to prevent contact with other metallic objects or batteries. This is to prevent fire or an explosion.
- If excessive heat, smoke, or fumes are emitted during battery pack recharging, immediately unplug the battery charger from the power outlet to stop the recharging and prevent a fire.
- If the battery pack or back-up battery leaks, changes color, deforms, or emits smoke or fumes, remove it immediately. Be careful not to get burned in the process.
- Prevent any battery leakage from contacting your eyes, skin, and clothing. It can cause blindness or skin problems. If the battery leakage contacts your eyes, skin, or clothing, flush the affected area with lots of clean water without rubbing it. See a physician immediately.
- During the recharging, keep the equipment away from the reach of children. The cord can accidentally choke the child or give an electrical shock.
- Do not leave any cords near a heat source. It can deform the cord or melt the insulation and cause a fire or electrical shock.
- Do not fire the flash at someone driving a car. It may cause an accident.
- Do not fire the flash near a person's eyes. It may impair the person's vision. When using flash to photograph an infant, keep at least 1 meter away.
- Before storing the camera or accessory when not in use, remove the battery pack and disconnect the power plug. This is to prevent electrical shock, heat generation, and fire.
- Do not use the equipment where there is flammable gas. This is to prevent an explosion or fire.

-
- If you drop the equipment and the casing breaks open to expose the internal parts, do not touch the internal parts due to the possibility of electrical shock.
 - Do not disassemble or modify the equipment. High-voltage internal parts can cause electrical shock.
 - Do not look at the sun or an extremely bright light source through the camera or lens. Doing so may damage your vision.
 - Keep the camera from the reach of small children. The neck strap can accidentally choke the child.
 - Do not store the equipment in dusty or humid places. This is to prevent fire and electrical shock.
 - Before using the camera inside an airplane or hospital, check if it is allowed. Electromagnetic waves emitted by the camera may interfere with the plane's instruments or the hospital's medical equipment.
 - To prevent fire and electrical shock, follow the safeguards below:
 - Always insert the power plug all the way in.
 - Do not handle a power plug with wet hands.
 - When unplugging a power plug, grasp and pull the plug instead of the cord.
 - Do not scratch, cut, or excessively bend the cord or put a heavy object on the cord. Also do not twist or tie the cords.
 - Do not connect too many power plugs to the same power outlet.
 - Do not use a cord whose insulation has been damaged.
 - Occasionally unplug the power plug and use a dry cloth to clean off the dust around the power outlet. If the surrounding is dusty, humid, or oily, the dust on the power outlet may become moist and short-circuit the outlet to cause a fire.
-

Preventing Injury or Equipment Damage

- Do not leave equipment inside a car under the hot sun or near a heat source. The equipment may become hot and cause skin burns.
 - Do not carry the camera around while it is attached to a tripod. Doing so may cause injury. Also make sure the tripod is sturdy enough to support the camera and lens.
 - Do not leave a lens or lens-attached camera under the sun without the lens cap attached. Otherwise, the lens may concentrate the sun's rays and cause a fire.
 - Do not cover or wrap the battery-recharging apparatus with a cloth. Doing so may trap heat within and cause the casing to deform or catch fire.
 - If you drop the camera in water or if water or metal fragments enter inside the camera, promptly remove the battery pack and back-up battery. This is to prevent fire and electrical shock.
 - Do not use or leave the battery pack or back-up battery in a hot environment. Doing so may cause battery leakage or a shorter battery life. The battery pack or back-up battery can also become hot and cause skin burns.
 - Do not use paint thinner, benzene, or other organic solvents to clean the equipment. Doing so may cause fire or a health hazard.
-

If the product does not work properly or requires repair, contact your dealer or your nearest Canon Service Center.

Digital Camera Model DS126251 Systems

This device complies with Part 15 of the FCC Rules. Operation is subject to the following two conditions: (1) This device may not cause harmful interference, and (2) this device must accept any interference received, including interference that may cause undesired operation.

Note: This equipment has been tested and found to comply with the limits for class B digital devices, pursuant to Part 15 of the FCC Rules. These limits are designed to provide reasonable protection against harmful interference in a residential installation. This equipment generates, uses and can radiate radio frequency energy and, if not installed and used in accordance with the instructions, may cause harmful interference to radio communications. However, there is no guarantee that interference will not occur in a particular installation. If this equipment does cause harmful interference to radio or television reception, which can be determined by turning the equipment off and on, the user is encouraged to try to correct the interference by one or more of the following measures:

- Reorient or relocate the receiving antenna.
- Increase the separation between the equipment and receiver.
- Connect the equipment into an outlet on a circuit different from that to which the receiver is connected.
- Consult the dealer or an experienced radio/TV technician for help.

The cable with the ferrite core provided with the digital camera must be used with this equipment in order to comply with Class B limits in Subpart B of Part 15 of the FCC rules.

Do not make any changes or modifications to the equipment unless otherwise specified in the manual. If such changes or modifications should be made, you could be required to stop operation of the equipment.

Canon U.S.A. Inc.
One Canon Plaza, Lake Success, NY 11042, U.S.A.
Tel No. (516)328-5600

This Class B digital apparatus complies with Canadian ICES-003.



When connecting to and using a household power outlet, use only AC Adapter Kit ACK-E6 (rated input: 100-240 V AC 50/60 Hz, rated output: 8.0 V DC). Using anything else can cause fire, overheating, or electrical shock.

IMPORTANT SAFETY INSTRUCTIONS

1. **SAVE THESE INSTRUCTIONS** — This manual contains important safety and operating instructions for Battery Charger LC-E6 & LC-E6E.
2. Before using the charger, read all instructions and cautionary remarks on (1) the charger, (2) the battery pack, and (3) the product using the battery pack.
3. **CAUTION** — To reduce risk of injury, charge only the Battery Pack LP-E6. Other types of batteries may burst, causing personal injury and other damage.
4. Do not expose the charger to rain or snow.
5. Use of an attachment not recommended or sold by Canon may result in fire, electric shock, or personal injury.
6. To reduce risk of damage to electric plug and cord, pull by plug rather than by cord when disconnecting charger.
7. Make sure cord is located so that it will not be stepped on, tripped over, or otherwise subjected to damage or stress.
8. Do not operate the charger with damaged cord or plug - replace them immediately.
9. Do not operate the charger if it has received a sharp blow, been dropped, or otherwise damaged in any way; take it to a qualified serviceman.
10. Do not disassemble the charger; take it to a qualified serviceman when service or repair is required. Incorrect reassembly may result in a risk of electric shock or fire.
11. To reduce risk of electric shock, unplug charger from outlet before attempting any maintenance or cleaning.

MAINTENANCE INSTRUCTION

Unless otherwise stated in this manual, there are no user serviceable parts inside. Refer servicing to qualified serviceman.



USA and Canada only:

The Lithium ion/polymer battery that powers the product is recyclable. Please call 1-800-8-BATTERY for information on how to recycle this battery.

For CA, USA only

Included lithium battery contains Perchlorate Material – special handling may apply.

See www.dtsc.ca.gov/hazardouswaste/perchlorate/ for details.

Index

10-sec. or 2-sec. delay 94
1280x720 156
1920x1080 156
19-point AF auto selection 87, 90
1st-curtain sync 117
2nd-curtain sync 117
4- or 9-image index display 165
640x480 156

A

AV OUT 169, 176
AC Adapter Kit 234
Access lamp 30
Add aspect ratio information 216
Adobe RGB 82
AE lock 106, 220
AEB 105, 206, 207
AF → Focusing
AF area selection mode 87, 89, 212
AF Microadjustment 211
AF point 87
AF point expansion 87, 89, 212
AF stop button 219
AF-ON (AF start) button 35
AI FOCUS (AI Focus AF) 86
AI SERVO (AI Servo AF) 86
 Characteristics 209, 210
AI Servo AF 52, 86
Aperture-priority AE 100
Audio/video OUT 169, 176
Auto Lighting Optimizer 49, 75
Auto playback 174
Auto power off 27, 44
Auto reset 81
Auto rotate of vertical images 182

Autofocus → Focusing
Automatic selection (AF) 87, 90
Automatic selection
of AF point 87, 90
Av (Aperture-priority AE) 100

B

B (Bulb) 107
B/W 65, 67
Battery → Power
Battery check 28
Battery Grip 28, 250
Beeper 50, 85, 238
Black-and-white image 65, 67
Bracketing 74, 105
Bulb 107
Bulb exposures 107

C

C1, **C2**, **C3** 20, 223
CA (Creative Auto) 53
Cable 3, 169, 176, 177
Camera
 Camera shake 109
 Clear camera settings 45
 Holding the camera 34
 Settings display 228
Camera shake 33, 35
Camera user settings 20, 223
Card 13, 29, 43
 Card reminder 29
 Format 43
 Problem 30
Center-weighted average
metering 103
CF card → Card
Charger 22, 24

- Cleaning 183
 - Clear camera settings 45
 - Clock 42
 - Color space 82
 - Color temperature 72
 - Color tone 66
 - Continuous 80
 - Continuous shooting 93, 229
 - Contrast 66
 - Copyright information 225
 - Cord 3, 169, 176, 177
 - Creative Auto 53
 - ★ icon 4
 - Cross-type focusing 91
 - Custom Functions 204
 - Clear all 204
- D**
- Date/Time 42
 - Date/time battery replacement 235
 - DC Coupler 234
 - Depth-of-field preview 101, 135
 - Digital terminal 190
 - Dioptric adjustment 34
 - Direct printing → Printing
 - Direct selection (AF point) 220
 - DPOF 199
 - Drive mode 93, 229
 - Dust Delete Data 185
- E**
- Electronic level 48, 134, 152, 221
 - Erase (image) 179
 - Error codes 249
 - Evaluative metering 103
 - Exposure compensation 104
 - Exposure level increments 206
 - Exposure simulation 136
 - Extension 81
 - External Speedlite → Flash
 - Eyecup 108
 - Eyepiece cover 23, 108
- F**
- Faithful 65
 - FE lock 114, 220
 - FEB 116
 - File name 80
 - File number 80
 - File size 59, 157, 163
 - Filter effect (Monochrome) 67
 - Fine (Image-recording quality) 59
 - Firmware Ver. 241
 - Flash
 - Custom Functions 118
 - Effective range 112
 - External Speedlite 115, 129
 - FE lock 114, 220
 - Flash control 115
 - Flash exposure compensation ... 113
 - Flash off 54
 - Flash-sync speed 111, 207
 - Manual flash 116
 - MULTI flash 116
 - Red-eye reduction 112
 - Shutter sync. (1st/2nd curtain) ... 117
 - Wireless 119
 - Flash exposure compensation 113
 - Flash mode 116
 - Flash-sync contacts 16
 - Focus confirmation light 50
 - Focus lock 52
 - Focus mode switch 31, 92, 145

Focusing

- AF area.....87, 89, 212
- AF characteristics...209, 210, 211, 219
- AF mode.....84, 220, 229
- AF point display.....213
- AF point registration214, 219
- AF point selection.....88, 220, 229
- AF-assist beam214
- Beeper.....50, 238
- Difficult-to-focus subjects...92, 142
- Live View shooting131
- Manual focusing92, 145, 213
- Movie shooting149
- Out of focus51, 92, 142, 145
- Recompose52
- Switch to registered AF
function.....219
- Folder Create/Select.....78
- Format (CF card initialization).....43
- Frame rate156
- Full Auto.....50
- Full HD.....149
- Full High-Definition156, 169, 177
- Function availability table.....236

G

- Grid display.....47, 136, 156

H

- HDMI.....169, 177
- High ISO speed noise reduction...208
- High-Definition156, 169, 177
- Highlight alert.....163
- Highlight detail loss.....163
- Highlight tone priority.....209
- Histogram (Brightness/RGB)164
- Hot shoe130
- Household power.....234

I

- ICC profile82
- Illumination
 - LCD panel.....37
 - Viewfinder213
- Image
 - AF point display163
 - Auto playback174
 - Auto rotate182
 - Erase179
 - Highlight alert.....163
 - Histogram164
 - Index.....165
 - Jump display
(Image browsing).....166
 - Magnified view167
 - Manual rotate168
 - Playback161
 - Protect178
 - Shooting information.....163
 - View on TV169, 176
- Image area.....32
- Image dust prevention.....183
- Image review time56
- Image Stabilizer (lens).....33
- Image-recording quality.....58
- Image verification data216
- Index display165
- ISO speed62, 153, 206, 229
 - Automatic setting63
 - ISO expansion206
 - Setting increments206

J

- JPEG.....58
- Jump display166

- L**
- Landscape 64
 - Language selection 42
 - Large (Image-recording quality) 59
 - LCD monitor 13
 - Brightness adjustment 181
 - Image playback 161
 - Menu settings 40, 238
 - Shooting settings display 229
 - LCD panel 18
 - Lens 21, 31
 - Lock release 32
 - Peripheral illumination correction 76
 - Live View shooting 131
 - Exposure simulation 136
 - Face detection Live mode (AF) ... 139
 - Grid display 136
 - Information display 134
 - Live mode (AF) 138
 - Manual focusing 145
 - Metering timer 137
 - Possible shots 133
 - Quick Control 135
 - Quick mode (AF) 143
 - Silent shooting 137
 - Long exposure noise reduction 208
- M**
- M (Manual exposure) 102
 - Magnified view 145, 167
 - Main Dial 36
 - Main Dial 36
 - Quick Control Dial 37
 - Malfunction 243
 - Manual exposure 102, 153
 - Manual focusing 92, 145, 213
 - Manual reset 81
 - Manual selection (AF) 87, 89
 - Maximum burst 59, 60
 - Medium (Image-recording quality) 59
 - Memory card → Card
 - Menu
 - Menu settings 238
 - My Menu 222
 - Setting operation 40
 - MENU** icon 4
 - Metering mode 103, 229
 - MF (Manual focusing) 92
 - Mirror lockup 109, 215
 - Mode Dial → Shooting mode
 - Monochrome image 65, 67
 - Movie 149
 - AF mode 156
 - Editing 173
 - Editing first/last scene 173
 - Enjoying 169
 - File size 157
 - Frame rate 156
 - Grid display 156
 - Information display 152
 - Manual exposure 153
 - Metering timer 157
 - Movie-recording size 156
 - Playback 171
 - Quick Control 155
 - Recording time 157
 - Silent shooting 157
 - Sound recording 157
 - Still image shooting 154
 - View on TV 169, 176
 - Multi-controller 36, 88
 - My Menu 222

- N**
- Neutral 65
 - Noise reduction
 - High ISO speed 208
 - Long exposures 208
 - Nomenclature 16
 - Non-Canon flash units 130
 - Normal (Image-recording quality) ... 58
 - NTSC 156, 240
 - Number 80
- O**
- ONE SHOT (One-Shot AF) 85
 - One-Shot AF 85
 - Operation button
 - customization 215, 217
- P**
- P (Program AE) 96
 - PAL 156, 240
 - Partial metering 103
 - PC terminal 16, 130
 - Peripheral illumination correction ... 76
 - Personal white balance 72
 - PictBridge 189
 - Picture Style 64, 69
 - Pixels 58
 - Playback → Image
 - Portrait 64
 - Possible shots 28, 59, 133
- Power**
- Auto power off 27, 44
 - Battery check 28
 - Battery info 230
 - Household power 234
 - Possible shots 28, 59, 133
 - Recharge 24
 - Pressing completely 35
 - Pressing halfway 35
 - Printing 189
 - Page layout 193
 - Paper settings 192
 - Print Order (DPOF) 199
 - Printing effects 194
 - Tilt correction 197
 - Trimming 197
 - Program AE 96
 - Program shift 97
 - Protect (image erase-protection) 178
- Q**
-  (Quick Control) 38, 135, 155
 - Quick Control Dial 37
 - Quick Control screen 38
 - Quick mode (AF) 143
- R**
- RAW 58, 60
 - RAW+JPEG 59, 61
 - Recharge 24
 - Recharge performance 25, 230
 - Red-eye reduction 112
 - Release shutter without card 29
 - Remote control shooting 108, 110
 - Remote Switch 108
 - Rotate (image) 168, 182, 197

S

Safety shift	207
Safety warnings	261
Saturation	66
Self-timer	94
Sensor cleaning	183
Sepia (Monochrome)	67
Sharpness	66
Shooting information display	163
Shooting mode	20
Aperture-priority AE	100
Bulb	107
Creative Auto	53
Full Auto	50
Manual exposure	102
Program AE	96
Shutter-priority AE	98
Shooting settings display	229
Shutter button	35
Shutter sync	117
Shutter-priority AE	98
Silent shooting	137, 157
Single image display	162
Single shooting	93
Single-point AF	87, 89
Slide show	174
Small (Image-recording quality)	58
Spot metering	103
sRGB	82
Stopped-down aperture	101
Strap	23
Subject tracking sensitivity	209
System map	250

T

Tone priority	209
Toning effect (Monochrome)	67
Tracking method	210
Trimming (printing)	197
Tripod socket	17
Tv (Shutter-priority AE)	98

U

Ultra DMA (UDMA)	29, 59, 154
USB (Digital) terminal	190
User defined	223

V

Video system	156, 176, 240
View on TV	169, 176
Viewfinder	19
Dioptic adjustment	34
Illumination	213
Volume (Movie playback)	172

W

WB → White balance	
White balance	70, 229
Bracketing	74
Correction	73
Custom	71
Personal	72
Wireless remote control	110

Z

Zone AF	87, 90, 212
---------------	-------------

Canon

CANON INC. 30-2, Shimomaruko 3-chome, Ohta-ku, Tokyo 146-8501, Japan

U.S.A. ————— **CANON U.S.A. INC.**

One Canon Plaza, Lake Success, NY 11042-1198, U.S.A.
For all inquiries concerning this product, call toll free in the U.S.
1-800-OK-CANON

CANADA ————— **CANON CANADA INC. HEADQUARTERS**

6390 Dixie Road, Mississauga, Ontario L5T 1P7, Canada
CANON CANADA INC. MONTREAL BRANCH
5990, Côte-de-Liesse, Montréal Québec H4T 1V7, Canada
CANON CANADA INC. CALGARY OFFICE
2828, 16th Street, N.E. Calgary, Alberta T2E 7K7, Canada
For all inquiries concerning this product, call toll free in Canada
1-800-OK-CANON

EUROPE, ————— **CANON EUROPA N.V.**

AFRICA & Bovenkerkerweg 59-61, 1185 XB Amstelveen, The Netherlands

MIDDLE EAST **CANON FRANCE S.A.S.**

17, Quai du Président Paul Doumer, 92414 Courbevoie Cedex, France

CANON UK LTD.

Woodhatch Reigate, Surrey RH2 8BF, United Kingdom

CANON DEUTSCHLAND GmbH

Europark Fichtenhain A10, 47807 Krefeld, Germany

CANON ITALIA S.p.A.

Via Milano 8, 20097 San Donato Milanese, (MI), Italy

CANON Schweiz A.G.

Industriestrasse 12, 8305 Dietlikon, Switzerland

Canon GmbH

Zetschegasse 11, A-1230 Vienna, Austria

CANON España, S.A.

Av. De Europa, 6 Alcobendas 28108 Madrid, Spain

CANON Portugal S.A.

Rua Alfredo da Silva, 14 Alfragide 2610-016 Amadora, Portugal

CENTRAL & ————— **CANON LATIN AMERICA, INC.**

SOUTH AMERICA 703 Waterford Way, Suite 400 Miami, FL 33126, U.S.A.

ASIA ————— **CANON (China) Co., LTD.**

15F Jinbao Building No.89 Jinbao Street, Dongcheng District, Beijing 100005, China

CANON HONGKONG CO., LTD.

19/F., The Metropolis Tower, 10 Metropolis Drive, Hung Hom, Kowloon, Hong Kong

CANON SINGAPORE PTE. LTD.

1 HarbourFront Avenue, #04-01 Keppel Bay Tower, Singapore 098632

CANON KOREA CONSUMER IMAGING INC.

Gangnam Finance Center 17F, 737, Yeoksam-Dong, Gangnam-Gu, Seoul, 135-984, Korea

OCEANIA ————— **CANON AUSTRALIA PTY. LTD.**

1 Thomas Holt Drive, North Ryde, Sydney N.S.W. 2113, Australia

CANON NEW ZEALAND LTD.

Akoranga Business Park, Akoranga Drive, Northcote, Auckland, New Zealand

JAPAN ————— **CANON MARKETING JAPAN INC.**

16-6, Kohnan 2-chome, Minato-ku, Tokyo 108-8011, Japan

This Instruction Manual booklet is current as of September 2009. For information on the camera's compatibility with any accessories and lenses introduced after this date, contact any Canon Service Center.